

# CHAMPAGNE

table | user guide



  
UMAGE



**USB**

The stand has a hidden, integral USB-port so you can charge your phone or tablet, even when the light is turned off.

## WITH LOVE FROM COPENHAGEN

At UIMAGE, our designers take inspiration from the distinct nature of the Nordic landscape to create unique designs related to the way we live in an urban setting. Influenced by the design language, colours and materials found around us in Scandinavia, we create a collection that is rooted in our home but designed for everyone.

Versatile, flexible and multifunctional, our furniture and accessory collection is designed for packing the most into life in smaller spaces!

## **ENGLISH**

If the external flexible cable or cord of this luminaire is damaged, it shall be exclusively replaced by the manufacturer or his service agent or a similar qualified person in order to avoid a hazard.

## **DEUTSCH**

Falls das äußere biegsame Kabel oder das Anschlusskabel dieser Beleuchtung beschädigt wird, darf es nur vom Hersteller, dessen Servicevertreter oder einer anderen qualifizierten Kraft ausgetauscht werden, um eventuelle Risiken auszuschließen.

## **FRANÇAIS**

Si le câble électrique de ce luminaire est endommagé, il peut être remplacé. Pour éviter tout danger, le remplacement doit impérativement être effectué par le fabricant, un représentant de celui-ci ou un réparateur agréé.

## **NEDERLANDS**

Als het snoer of de buitenste flexibele kabel van deze verlichting beschadigd is, mag deze uitsluitend door de fabrikant, diens service-agent of een andere vakman vervangen worden. Dit om eventuele risico's te vermijden.

## **DANSK**

Hvis det ydre, bøjelige kabel eller ledningen til lampen beskadiges, må den kun udskiftes af producenten, dennes serviceagent eller en anden kvalificeret person for at undgå farlige situationer.

## **ÍSLENSKA**

Ef ytri sveigjanlega snúran í þessu ljósi er skemmd þarf að leita til framleiðandans, þjónustuaðila eða annars fagaðila til að skipta henni út fyrir nýja svo að hægt sé að fyrirbyggja að hætta skapist.

## **NORSK**

Om kabelen eller ledningen til denne belysningen blir skadet, får den kun byttes ut av leverandøren, dennes serviceagent eller en annen kvalifisert fagmann for å unngå eventuell fare.

## **SUOMI**

Jos valaisimen uloin, taipuisa kaapeli tai johto vioittuu, turvallisuussyistä sen saa vaihtaa vain valmistaja tai valtuutettu huoltoliike.

## **SVENSKA**

Om den yttre böjliga kabeln eller sladden till denna belysning skadas, får den endast bytas ut av tillverkaren eller dennes serviceagent eller annan behörig person, för att undvika eventuella risker.

## **ČESKY**

Je-li vnější přívodní kabel svítidla poškozen, musí být vyměněn pouze výrobcem, autorizovaným servisem nebo jiným kvalifikovaným odborníkem, aby nedošlo k ohrožení zdraví.

## **ESPAÑOL**

Si se dañase el cable exterior flexible de esta lámpara, para evitar riesgos deberá ser sustituido exclusivamente por el fabricante, su representante o un electricista cualificado.

## **ITALIANO**

Se il cavo flessibile esterno o filo elettrico di questa illuminazione è danneggiato, può essere sostituito esclusivamente dal produttore, da un centro di assistenza autorizzato o da un elettricista qualificato, per evitare rischi.

## **MAGYAR**

Ha a külső rugalmas vezető vagy kábel megsérül, biztonsági okból csak szakember vagy a szerviz munkatársai végezhetik el a cserét.

## **POLSKI**

Jeżeli zewnętrzny przewód lampy ulegnie uszkodzeniu, w celu uniknięcia zagrożeń jego wymiany może dokonać jedynie producent, jego przedstawiciel serwisowy lub inna wykwalifikowana osoba.

## **EESTI**

Kui selle valgusti väline kaabel või juhe on kahjustatud, vahetab selle erilise juhtme vastu ainult tootja või tema esindaja, selleks, et vältida ohtlikke olukordi.

## **LATVIEŠU**

Lai izvairītos no riska, šīs lampas vadu/kabeļu bojājumus drīkst novērst tikai ražotājs, servisa pārstāvis vai cita kvalificēta persona.

## **LIETUVIŲ**

Jei lankstus kabelis ar laidas pažeistas, jį turi pakeisti gamintojas, jo techninio aptarnavimo atstovas ar kvalifikuotas specialistas.

## **PORTUGUÊS**

Se o cabo exterior flexível deste candeeiro se danificar, deverá ser substituído exclusivamente pelo fabricante ou seu representante ou por uma pessoa qualificada, para evitar acidentes.

## **ROMÂNĂ**

Dacă cablul electric al acestui corp de iluminat este deteriorat, va fi înlocuit numai de către producător sau de agentul de servicii al acestuia, sau de către o altă persoană specializată, pentru a evita accidentările.

## **БЪЛГАРСКИ**

Ако външният подвижен кабел на лампата бъде повреден, той трябва да бъде подменен единствено от производителя, негов представител или друго квалифицирано лице, за да се избегнат рискове.

## **HRVATSKI**

Ako je strujni kabel oštećen, mora ga zamijeniti isključivo proizvođač ili njegov ovlaštenu servisera ili slična kvalificirana osoba kako bi se izbjegla opasnost.

## **SLOVENSKY**

V prípade, ak sa vonkajší zdrojový kábel svietidla poškodí, je nutné, aby

ho vymenil výrobca alebo jeho servisný zástupca, prípadne kvalifikovaný elektrikár tak, aby nedošlo k ohrozeniu zdravia.

## **ΕΛΛΗΝΙΚΑ**

Εάν το εξωτερικό ευέλικτο καλώδιο αυτού του φωτιστικού φθαρεί, για την αποφυγή ατυχήματος, θα πρέπει να αντικατασταθεί μόνο από τον κατασκευαστή ή το εξουσιοδοτημένο σέρβις του ή από ένα άλλο ειδικευμένο άτομο.

## **РУССКИЙ**

Если наружный гибкий удлинитель или шнур этого светильника поврежден, то во избежание несчастного случая его должен заменить либо сам производитель, либо представитель сервисной службы производителя, либо человек соответствующей квалификации.

## **SRPSKI**

Ako je spoljni savitljivi kabl ili vod ove lampe oštećen, u cilju izbegavanja rizika, treba da ga zameni isključivo proizvođač, ovlašćeni serviser ili stručna osoba.

## **SLOVENŠČINA**

Če je zunanji kabl ali žica svetila poškodovan/a, naj zamenjavo opravi proizvajalec, njegov pooblaščen serviser ali podobno usposobljena oseba. S tem se izognete nepotrebnim tveganjem.

## **TÜRKÇE**

Bu aydınlatmanın harici esnek kablosu veya kordonu zarar görürse, tehlikeden kaçınmak için üretici firma veya üretici firma yetkili servisi veya benzeri bir kişi tarafından değiştirilecektir.

## **BAHASA INDONESIA**

Jika bagian luar kabel fleksibel atau kabel sambungan untuk penerangan

ini rusak, maka harus digantikan oleh pabrik pembuat atau agen pelayanannya atau orang yang berkualifikasi agar terhindari dari bahaya.

## **BAHASA MALAYSIA**

Jika kabel atau kord fleksibel luaran bagi lampu ini telah rosak, ia patut diganti secara eksklusif oleh pengeluar atau ejen perkhidmatannya atau individu yang berkelayakan agar bahaya dapat dielakkan.

## **한국어**

본 조명기구의 가요성 외부 케이블이나 코드가 손 상되었을 경우 위험한 사고를 방지하기 위해 반드시 제조사, 지정 서비스 업체, 또는 전문가에 의해 교체되어야 합니다.



## 日本語

この照明器具の外部ケーブルやコードが破損した場合は、修理に伴う事故を避けるため、必ず製造元のメーカーや代理店、電気工事店などに部品交換を依頼してください。

## 中文

如果这种照明装置的外部软电缆或电线受到损坏，必须由制造商、其代理商或具有相近资质的人员进行更换，防止发生伤害事故。

## 繁中

如果燈具的外部電線受損，應由製造商，服務人員或相關的專業人員替換，以避免發生危險。

# ASSEMBLY GUIDE

Ⓐ x 1 pc.

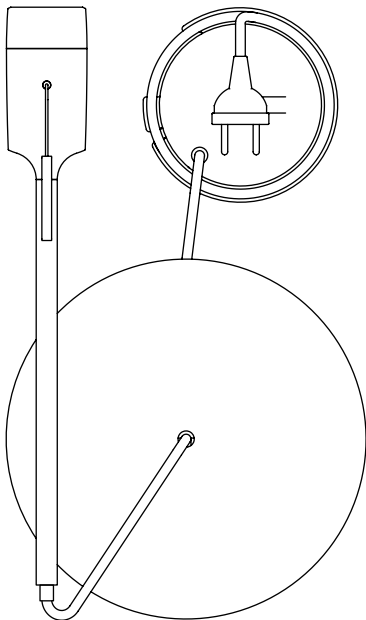

① x 1 pc.

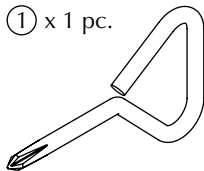

Ⓑ x 5 pcs.



Ⓒ x 1 pc.



Find assembly videos by using the QR code or by going online at our website  
[umage.com/instructions](http://umage.com/instructions)

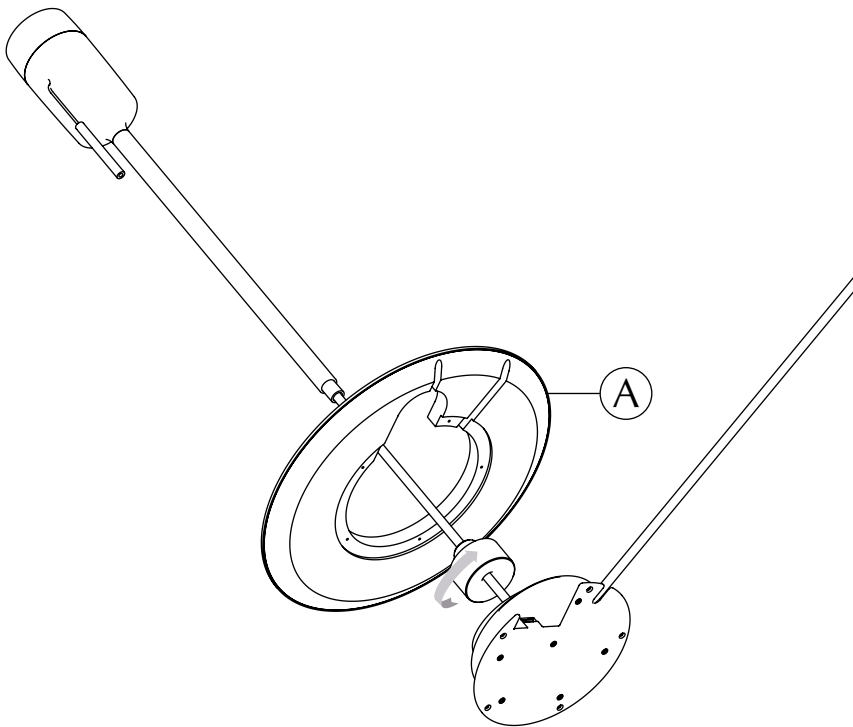

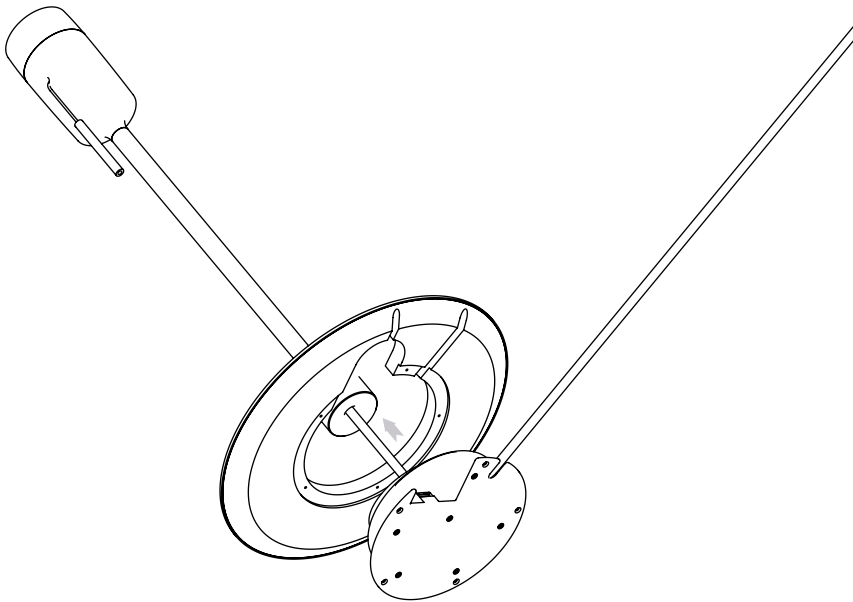

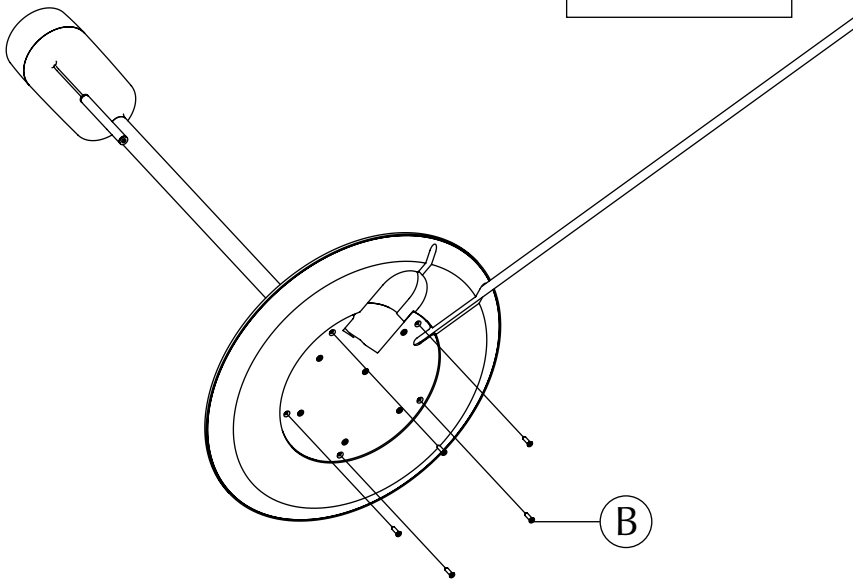
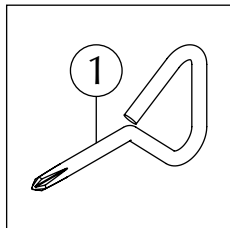

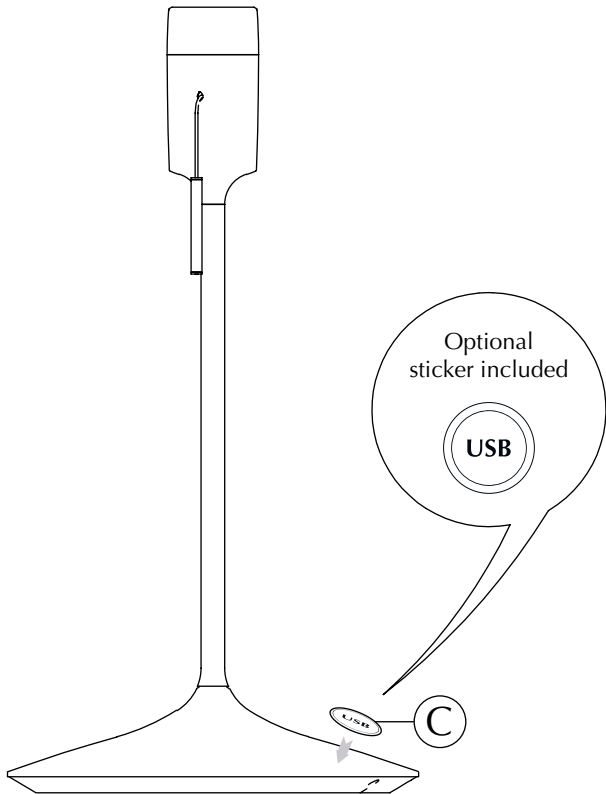



DESIGNED BY  
ANDERS KLEM

“ There is always the  
one that with quiet  
grace and elegance  
draws our eyes,  
without even trying. ”

**ALUVIA**  
brushed brass





**CHAMPAGNE**  
floor | white



**SILVIA**  
medium | white





# UIMAGE UNFOLD AT HOME

GET THE FREE UIMAGE APP

Preview our entire collection in your own home – before you buy

Imagine an UIMAGE lamp or furniture piece in your home. Is it the right design, size and colour? We made it easier for you to find the perfect UIMAGE design. Just download our free **UIMAGE Unfold at Home** app from the App Store or Play Store, and see how our designs will look in your home!



FOLLOW US ON SOCIAL MEDIA



@umagedesign | #umagedesign | [umage.com](http://umage.com)



U.M.A.G.E.