

# ASSEMBLY INSTRUCTION FOR PSN 9200-GLS-ST (LOZKO NOCNA ET-920)

- Notes:
- Read instructions carefully.
  - Carefully identify each component especially those that are similar.
  - Apply the correct assembly sequence and use the hardware pack and fasteners in its proper location before starting.
  - Check new floor for uneven or soft areas or soundings.

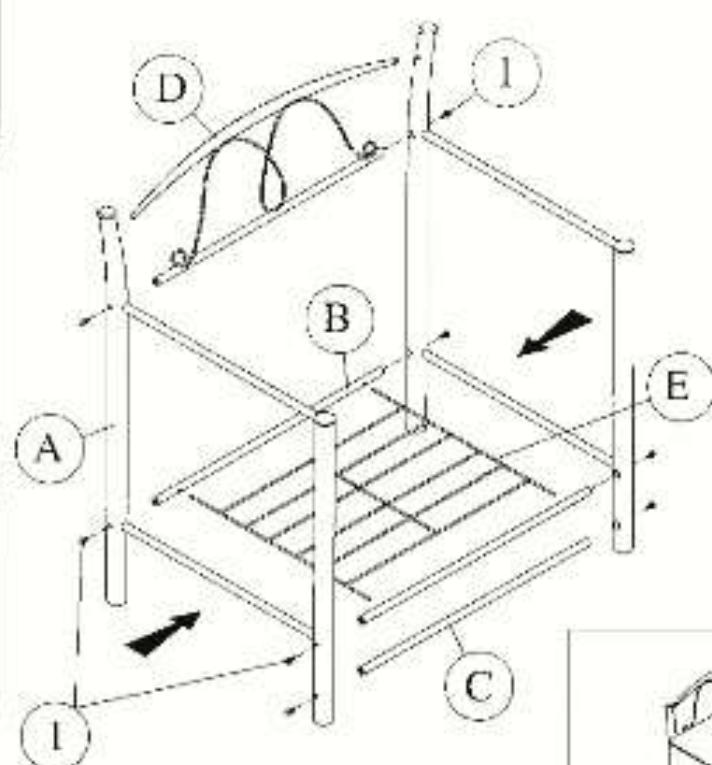

1 Person



## STEP 1

Please put all parts together in the correct position and then tie with bolts as shown.

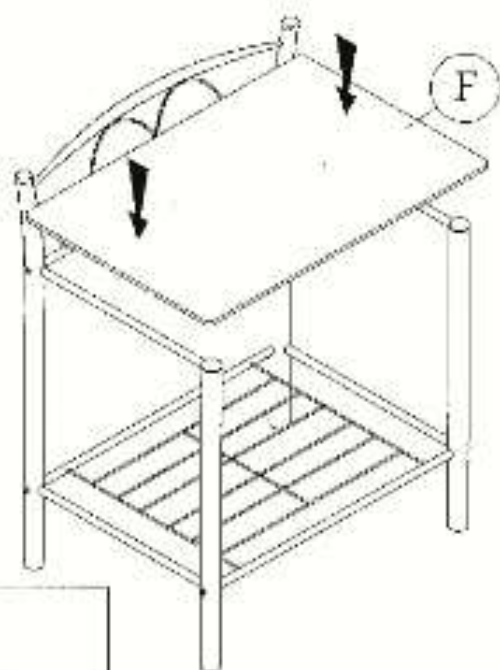





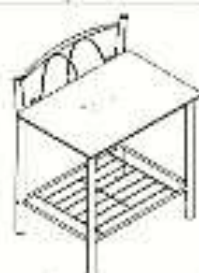

## STEP 2

After complete base unit installation, please put table glass as shown.

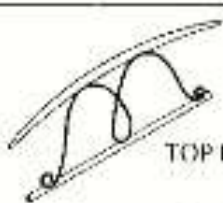

Complete Assembly

## HARDWARE & PART LIST

| NO | PART   | QTY   | NO | PART   | QTY   |
|----|--|-------|----|--|-------|
| A  |  SIDE FRAME       | 2 pcs | E  |  BOTTOM TRAY    | 1 pc  |
| B  |  BOTTOM TRAY RAIL | 2 pcs | F  |  TABLE GLASS     | 1 pc  |
| C  |  BOTTOM RAIL      | 1 pc  | NO | HARDWARE   | QTY   |
| D  |  TOP BACK FRAME   | 1 pc  | 1  |  M6x20mm         | 8 pcs |
|    |  |       | 2  |  M6 - ALLEN KEY | 1 pc  |

Please follow our Assembly Instruction procedure for easier assemble.