

NOTICE DE MONTAGE

INSTRUCCIONES DE MONTAJE / ASSEMBLY INSTRUCTIONS

ME
marckeric
MARCKERIC S.L.
C/ENLACE VEROLA S/N
PC:46430/SOLLANA/VALENCIA/SPAIN

ROUND COFFEE TABLE HILLARY
MESA CENTRO RED. HILLARY
TABLE BASSE RONDE HILLARY

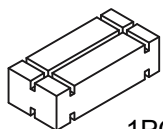

1PC / 1CTN

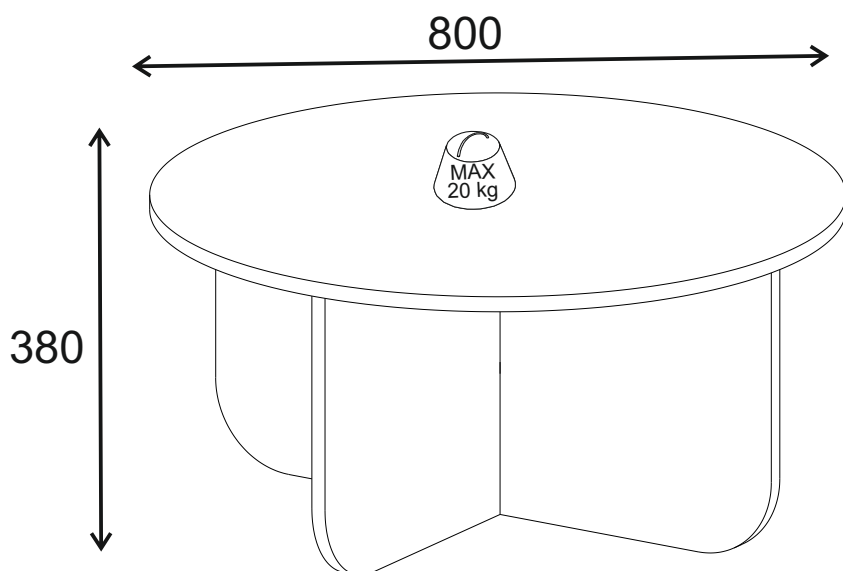

AVANT DE COMMENCER, SE
REPORTER AUX CONSEILS
DE MONTAGE EN ANNEXE

**BEFORE STARTING, REFER
TO THE ASSEMBLING ADVICE
IN ANNEX**

VOR DER MONTAGE,
BEILIGE ANWEISUNGEN
BEFOLGEN.

**PRIMA DI COMINCIARE
LEGGETE LE ISTRUZIONI
DI MONTAGGIO**

ANTES DE COMEÇAR, DAR
SE AOS CONSELHOS DE
MONTAGEM EM ANEXO

**ANTES DE EMPEZAR
CONSULTE LOS CONSEJOS
PARA EL MONTAJE**

PRIJE POČETKA POGLEDAJTE
ZA SAVJET ZA MONTAŽU
U ANEKSU

**BAŞLAMADAN ÖNCE,
EKTEKİ MONTAJ
TALİMATLARINI İNCELEYİNİZ**

"NE PAS UTILISER SI UNE PARTIE EST CASSÉE,
ENDOMMAGÉE OU MANQUANTE"

"IMPORTANT - À CONSERVER POUR RÉFÉRENCE
ULTÉRIEURE - LIRE ATTENTIVEMENT"

À MONTER SOI-MÊME

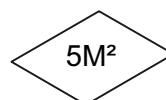
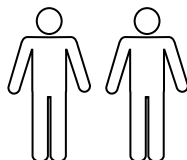
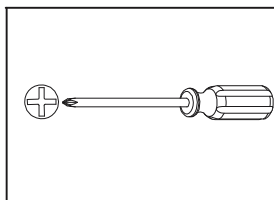
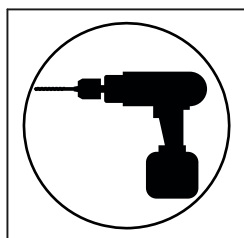

9577

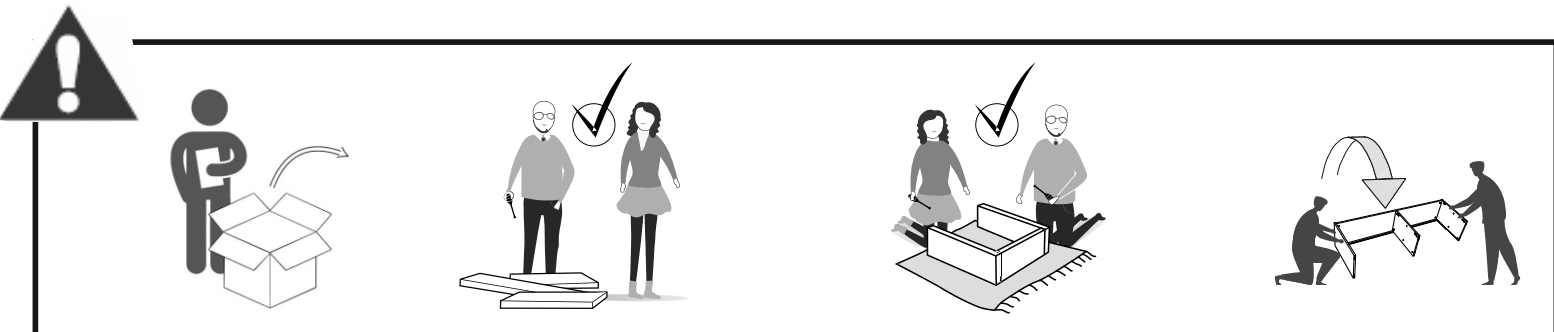

FRANÇAIS:

- BASCULER LE MEUBLE AVEC PRÉCAUTION.
- UTILISATION D'UNE COUVERTURE RECOMMANDÉE POUR NE PAS ABIMER LE MEUBLE.

Après assemblage de ce produit, il est conseillé d'aérer régulièrement la pièce pendant quelques jours.

ENGLISH:

- TURN THE FURNITURE CAREFUL.
- USE A COVER TO AVOID DAMAGE THE FURNITURE.

After assembling this product, it is recommended to regularly ventilate the room for a few days.

ESPAÑOL:

- GIRAR EL MUEBLE CON CUIDADO.
- UTILICE UNA FUNDA/COBERTOR DEBAJO DEL MUEBLE PARA EVITAR DAÑARLO DURANTE EL MONTAJE

Después de montar este producto, es aconsejable ventilar la habitación frecuentemente, durante algunos días.

ITALIANO:

- INCLINARE ATTENTAMENTE I MOBILI.
- UTILIZZANDO UNA COPERTURA CONSIGLIATA PER NON DANNEGGIARE I MOBILI.

Dopo aver montato il prodotto si consiglia di ventilare la stanza per alcuni giorni.



<https://quefairedemesdechets.fr>

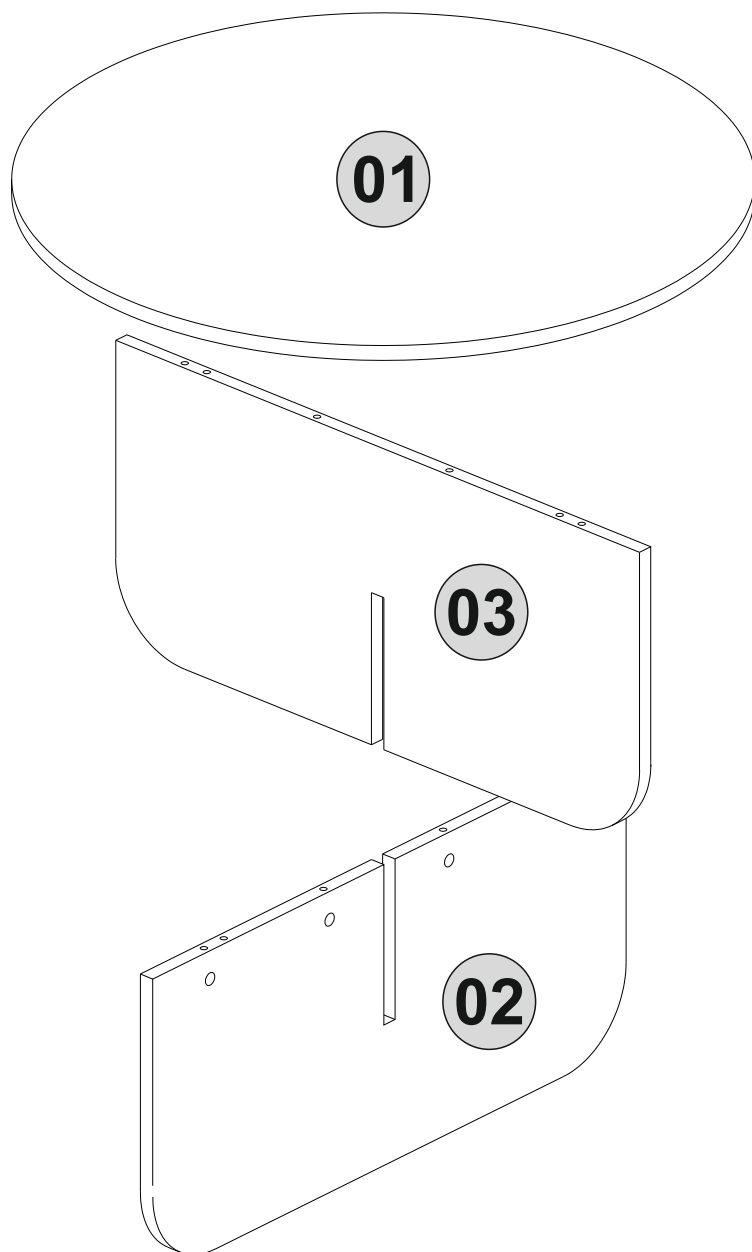





CAJA/COLIS 1/1

1 x PIECE 01
1 x PIECE 02
1 x PIECE 03

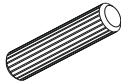

HOJA DE MONTAJE
ASSEMBLY INSTRUCTIONS
NOTICE DE MONTAGE

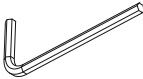
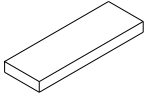
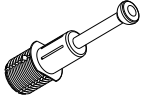
HERRAJES
HARDWARE
QUINCALLERIE

HERRAJES / QUINCALLERIE / HARDWARE

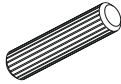

A04	A06	A12	Pb01	A23	A22
 <p>8PCS</p>	 <p>C2-8PCS</p>	 <p>1PC</p>	 <p>8PCS</p>	 <p>8PCS</p>	 <p>8PCS</p>

Step 1 / ETAPE 1

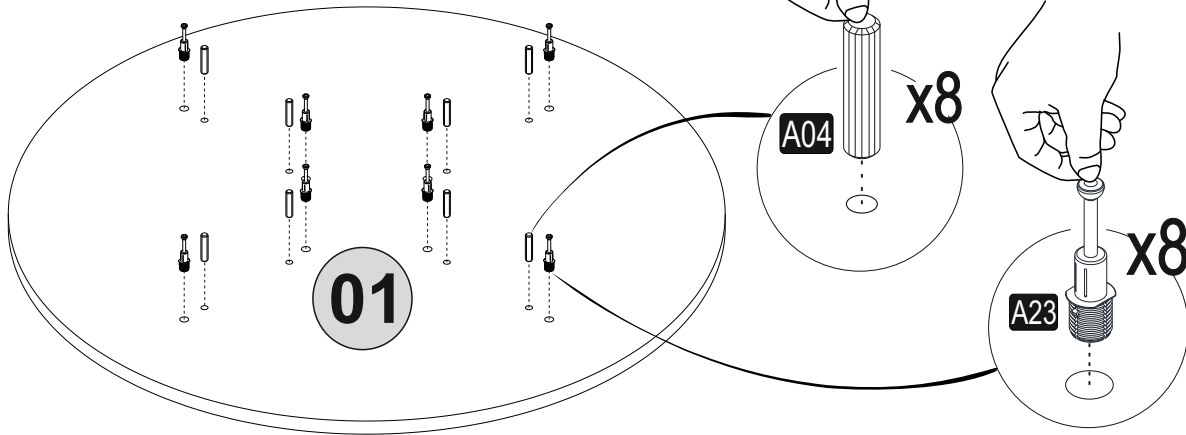
A04	A23
	
8PCS	8PCS



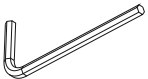

Step 2 / ETAPE 2

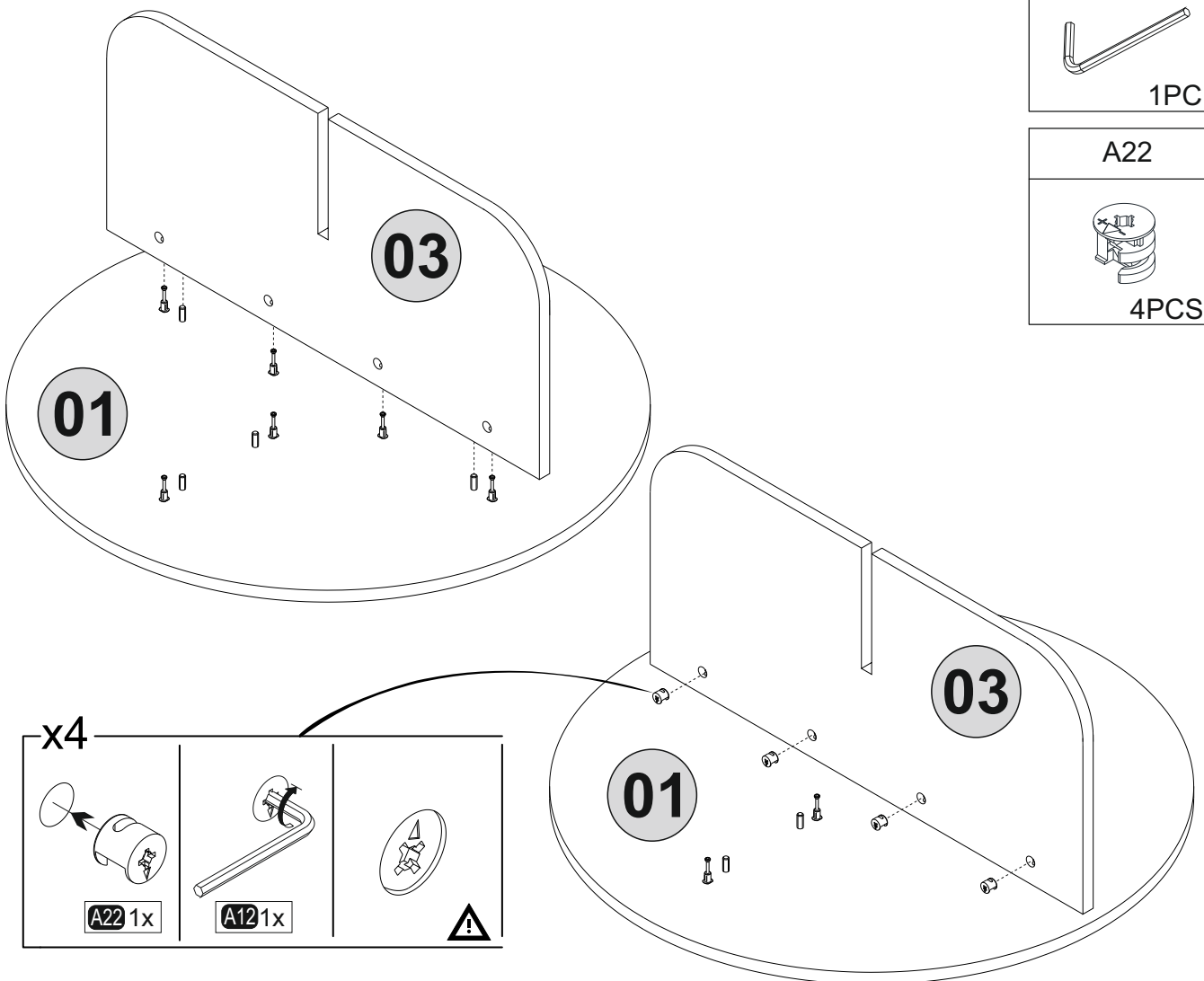
A12

1PC
A22

4PCS

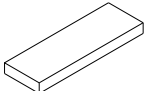
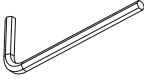

Step 3 / ETAPE 3

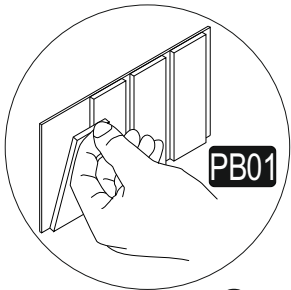
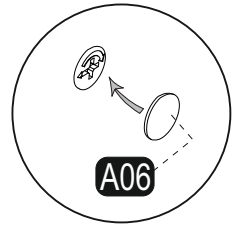
A06	A22	Pb01	A12
			
8PCS	4PCS	8PCS	1PC

ID LABEL



x8

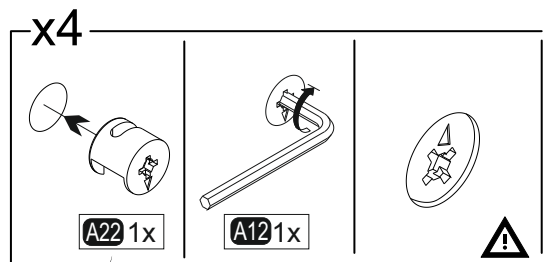
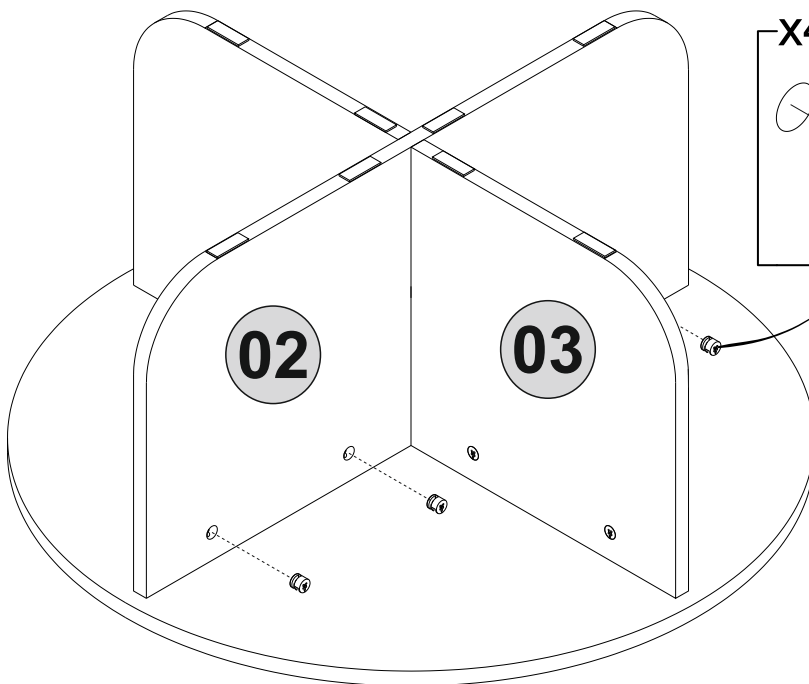
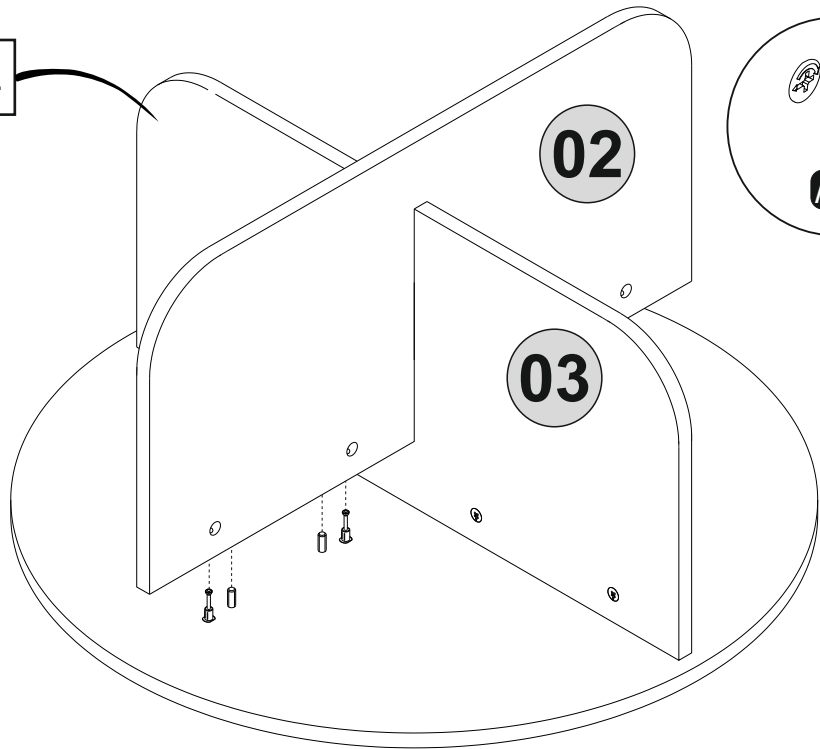
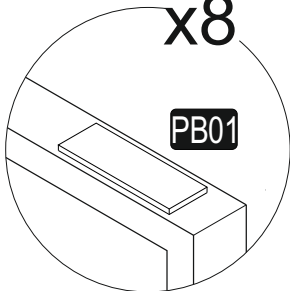

FRANCAIS - SUISSE

CONSEILS DE MONTAGE :

- 1 > BIEN ETUDIER LA NOTICE DE MONTAGE.
- 2 > REPEREZ LES PIÈCES CONSTITUANT VOTRE MEUBLE.
- 3 > REGROUPEZ ET CONTROLEZ LA QUINCAILLERIE.
- 4 > MUNISSEZ-VOUS DE L'OUTILLAGE NECESSAIRE.
- 5 > AMENAGEZ-VOUS UNE ZONE DE MONTAGE.
- 6 > PROCEDEZ AU MONTAGE.

NE JAMAIS FORCER LES ASSEMBLAGES. RESERRER LES VIS APRES QUELQUES TEMPS D'USAGE. GARDER VOTRE NOTICE DE MONTAGE, SI UNE PIÈCE VENAIT A MANQUER, ELLE SERAIT LE PLUS CLAIR MOYEN DE COMMUNIQUER AVEC VOTRE MAGASIN.

CONSEILS D'ENTRETIEN :

- 1 > DÉPOUSSIÉREZ SOIGNEUSEMENT.
- 2 > UTILISEZ UN CHIFFON SEC.

- NE JAMAIS UTILISER DE PRODUITS ABRASIFS: POUDDRE, LAINE D'ACIER, SOLVANTS. - NE PAS MOUILLER

	PAPIER DECOR	SURFACES STRATIFIÉES	SURFACES LAQUÉES	BOIS VERNIS	TEXTILE CUIR
EAU SAVONNEUSE (SAVON NEUTRE)	○	○	○	○	○
EAU ADDITIO NÉ		○	○		
ENTRETIEN SPÉCIFIQUE FABRICANT					○

DEUTSCH - SCHWEIZ

MONTAGE ANLEITUNG:

- 1 > DIE MONTAGEANLEITUNG SORGFÄLTIG DURCHLESEN.
- 2 > DIE EINZELTEILE DES MÖBELSTÜCKS ERMITTELN.
- 3 > DIE BESCHLÄGE ZUSAMMENLEGEN UND PRÜFEN.
- 4 > DAS NOTWENDIGE WERKZEUG ZURECHTLEGEN.
- 5 > EINEN MONTAGEBEREICH FREIMACHEN.
- 6 > DAS MÖBELSTÜCK ZUSAMMENBAUEN.

NIEMALS DIE VERBINDUNGEN ZU STARK ANZIEHEN. DIE SCHRAUBEN NACH EINIGER ZEIT DES GEBRAUCHS ERNEUT FESTZIEHEN. DIE MONTAGEANLEITUNG GUT AUFBEWAHREN: SOLLTE EIN TEIL FEHLEN, IST SIE DAS BESTE VERSTÄNDIGUNGSMITTEL MIT IHREM GESCHÄFT.

PFLEGEHINWEISE :

- 1 > SORGFÄLTIG ENTSTAUBEN.
- 2 > VERWENDEN SIE EIN TROCKENES TUCH.

- BENUTZEN SIE KEINE SCHEUERMITTEL WIE PULVER, STAHLWOLLE, LÖSUNGSMITTEL. - KEIN WASSER VERWENDEN.

	DEKORPAPIER	OBERFLÄCHE LAMINAT	OBERFLÄCHE LACK	LACKIERTEM HOLZ	TEXTIL LEDER
SEIFENLAUGE (NEUTRALSEIFE)	○	○	○	○	○
WASSER MIT HAUSHALTSRFINGIGER		○	○		
PRODUZENT SPEZIFISCHER UNTERHALI					○

ITALIANO - SVIZZERA

CONSIGLI DI MONTAGGIO

- 1 > STUDIARE BENE LE ISTRUZIONI DI MONTAGGIO.
- 2 > PRENDERE CONOSCENZA DEI PEZZI CHE COSTITUISCONO IL MOBILE.
- 3 > RAGGRUPPARE E CONTROLLARE LA FERRAMENTA.
- 4 > MUNIRSI DEGLI UTENSILI NECESSARI.
- 5 > PREPARARE UNA ZONA DI MONTAGGIO.
- 6 > PROCEDERE AL MONTAGGIO.

NON FORZARE MAI GLI ASSEMBLAGGI RISTRINGERE LE VITI DOPO UN PERIODO D'USO CONSERVARE QUESTE ISTRUZIONI DI MONTAGGIO, SE UN PEZZO VENISSE A MANCARE SAREBBE IL MIGLIORE MEZZO DI COMUNICAZIONE CON IL RIVENDITORE

CONSIGLI PER LA MANUTENZIONE :

- 1 > SPOLVERATE ACCURATAMENTE.
- 2 > USARE UN PANNINO ASCIUTTO.

- NON UTILIZZARE MAI PRODOTTI ABRASIVI: POLVERE, LANA DI ACCIAIO, SOLVENTI. - NON BAGNARE.

	CARTA	SUPERFICIE STRATIFICATE	SUPERFICIE LACCATE	LACCATE EGNO VERNICIATO	TESSILE CUIOIO
ACQUA CON SAPONE (SAPONE NEUTRO)	○	○	○	○	○
ACQUA CON DETERSIVO SAN MARC		○	○		
MANUTENZIONE SPECIFICA PRODUTTORE					○

PORTUGUÊS

CONSELHOS DE MONTAGEM:

- 1 > ESTUDE BEM AS INSTRUÇÕES DE MONTAGEM.
- 2 > REUNA AS PEÇAS QUE CONSTITUEM O SEU MÓVEL.
- 3 > REAGRUPE AS FERRAGENS.
- 4 > EQUIPE-SE COM AS FERRAMENTAS NECESSÁRIAS.
- 5 > PREPARE UMA ÁREA PARA A MONTAGEM.
- 6 > INICIE A MONTAGEM.

NUNCA FORÇAR OS ENCAIXES. REAPERTAR OS PARAFUSOS APÓS UM TEMPO DE UTILIZAÇÃO. GUARDAR AS INSTRUÇÕES DE MONTAGEM. CASO FALTE ALGUMA PEÇA, O MAIS ACONSELHÁVEL É CONTATAR O REVENDEDOR.

CONSELHOS PARA A MANUTENÇÃO :

- 1 > ELIMINAR BEM O PÓ.
- 2 > USAR PANO SECO.

- NUNCA UTILIZAR PRODUTOS ABRASIVOS: SAPONÁCEOS, LÃ DE AÇO, SOLVENTES. - NÃO MOLHAR .

	ACABAMENTO IMITAÇÃO	SUPERFICIES ESTRATIFICADAS	SUPERFICIES LACADAS	MADEIRA ENVERNIZADA	TEXTÉIS PELES
ÁGUA COM SABÃO (SABÃO NEUTRO)	○	○	○	○	○
ÁGUA COM DETERGENTE		○	○		
INSTRUÇÕES ESPECÍFICAS DO FABRICANTE					○

ESPAÑOL

CONSEJOS PARA EL MONTAJE:

- 1 > ESTUDIE ATENTAMENTE EL MANUAL DE MONTAJE.
- 2 > LOCALICE LAS PIEZAS QUE CONSTITUYEN SU MUEBLE.
- 3 > REUNA Y CONTROLE LOS TORNILLOS.
- 4 > EQUIPE-SE DE LAS HERRAMIENTAS NECESARIAS.
- 5 > PREPARE UNA ZONA DE MONTAJE.
- 6 > REALICE EL MONTAJE.

NO FUERCE NUNCA EN LAS UNIONES. APRIETE LOS TORNILLOS DESPUES DE CIERTO TIEMPO DE UTILIZACION CONSERVE SU MANUAL DE MONTAJE, SI FALTARA UNA PIEZA, SERIA LA MANERA MAS FACIL DE COMUNICAR CON LA TIENDA.

CONSEJOS PARA EL MANTENIMIENTO:

- 1 > DESPOLVOREAR CULDADOSAMENTE.
- 2 > UTILICE UN PAÑO SECO.

- NO USE NUNCA PRODUCTOS ABRASIVOS TALES COMO: POLVO DE LIMPIAR, LANA DE ACERO, SOLVENTES. - NO MOJAR.

	PAPEL DE DECORACION	SUPERFICIE ESTRATIFICADAS	SUPERFICIE MAQUEADAS	MADERA BARNIZADA	TEKULL CUERO
AGUA Y JABON (JABON NEUTRO)	○	○	○	○	○
AGUA COM DETERGENTE		○	○		
MANTENIMIENTO ESPECIFICO DEL FABRICANTE					○

HRVATSKA

UPUTE ZA MONTAŽU:

- 1 > PAŽLJIVO PROČITAJTE UPUTE ZA MONTAŽU.
- 2 > PRIPREMITE SVE DIJELOVE NAMJEŠTAJA.
- 3 > PRIKUPITE I PROVJERITE OKOVE ZA MONTAŽU.
- 4 > PRIPREMITE POTREBAN ALAT.
- 5 > PRIPREMITE PROSTOR ZA MONTAŽU.
- 6 > POČNITE MONTIRATI.

NEMOJTE UPOTREBLJAVATI SILU PRILIKOM SKLAPANJA NAKON NEKOG VREMENA PONOVRNO PRITEGnite VIJKE ČUVAJTE UPUTE ZA MONTAŽU U SLUČAJU NEDOSTATKA NEKOG DIJELA NAJBOLJE ĆE BITI DA DA KONTAKIRATE PRODAJNO MJESTO.

UPUTE ZA ODRŽAVANJE :

- 1 > PAŽLJIVO OBRISATI PRAŠINU.
- 2 > KORISTITE SUHU KRPU.

- ZABRANJENA JE UPOTREBA KEMIKALIJA ILI BILO KAKVIH POMOĆNIH SREDSTAVA ZA RIBANJE JAKIH SREDSTAV ZA ČIŠĆENJE ILI ĆELIĆNE VUNE -NE MOKRA.

	PAPIR	LAMINAT	LAK	DRVO	TEKSTIL/ KOŽA
OTPINA SAPUNA	○	○	○	○	○
OTPINA DETERDŽENTA		○	○		
NAMJENSKA SREDSTVA					○

TÜRÇE

MONTAJ TALIMATLARI:

- 1 > MONTAJ TANITIM YAZISINI DIKKATILICE OKUYUNUZ .
- 2 > MOBILYANIZI OLUŞTURAN PARÇALARI İŞARETLEYİNİZ.
- 3 > HIRDAVATLA İLGİLİ PARÇALARI BİR ARAYA TOPLAYIP; KONTROL EDİNİZ.
- 4 > GEREKEN ARAÇ VE GEREKİ TEDARİK EDİNİZ.
- 5 > (KENDİNİZE) BİR MONTAJ ALANI EDİNİNİZ.
- 6 > MONTE ETMEYE BAŞLAYINIZ.

MONTAJLARI ZORLAMAYINIZ. BİRKAÇ KULLANIMDAN SONRA VIDALARI SIKIŞTIRINIZ. BİR PARÇANIN KAYBOLMASI DURUMUNDA MAGAZANIZLADAHAKOLAY İLETİŞİME GEÇEBİLMENİZ İÇİN MONTAJ KULLANIM TALIMATINIZI SAKLAYINIZ.

BAKIM TALIMATLARI:

- 1 > TOZUNU DIKKATLİCE ALINIZ.
- 2 > YUMUŞAK BİR BEZİ TEMİZ SU VE AZ MIKTARDA SABUNLA(DETERJAN) NEMLENDİRİNİZ.

ASLA AŞINDIRICI ÜRÜNLER KULLANMAYINIZ : ĆELİK YÜNÜ, SOLVENT... BOL SUYLA YIKAMAYINIZ.

	SÜS KAGIDI	KATMAN YÜZEY	LAKE YÜZEY	CILALI TAHTA	TEKSTİL DERİ
SABUNLU SU (NOTR SABUN)	○	○	○	○	○
DETERJAN KATILMIŞ SU		○	○		
ÜRETİCİYE ÖZGÜ BAKIM					○

ENGLISH

ASSEMBLY ADVICE :

- 1 > CAREFULLY READ THE ASSEMBLY INSTRUCTION.
- 2 > IDENTIFY THE COMPONENTS OF THE FURNITURE.
- 3 > GROUP AND CHECK THE HARDWARE.
- 4 > USE THE REQUIRED TOOLS.
- 5 > CREATE AN ASSEMBLY ZONE.
- 6 > MAKE THE ASSEMBLY.

NEVER FORCE THE CONNECTIONS. RE-TIGHTEN THE SCREWS AFTER FEW DAYS. PLEASE RETAIN THE AI LEAFLET FOR FUTURE REFERENCE, THE AI CONTAINS INFORMATION WHEN CLAIMING FOR MISSING PARTS.

CLEANING ADVICE:

- 1 > CAREFULLY REMOVE THE DUST.
- 2 > USE A SOFT, CLEAN DAMP CLOTH WITH SOAPY WATER.

NEVER USE ABRASIVE PRODUCTS OR SOLVENTS. DO NOT APPLY EXCESSIVE PRESSURE WHEN USING THE DAMP CLOTH.

	PAPER DECOR	LAMINATED SURFACES	LACQUERED SURFACE	VARNISHED WOOD	LEATHER TEXTILE
SOAPY WATER (NEUTRAL SOAP)	○	○	○	○	○
WATER WITH DETERGENT		○	○		
SPECIFIC SUPPLIER CLEANING					○