

# NOTICE DE MONTAGE

## INSTRUCCIONES DE MONTAJE / ASSEMBLY INSTRUCTIONS

**ME**  
marckeric

MARCKERIC S.L.  
C / ENLACE VEROLA S/N,  
PC: 46430/SOLLANA / VALENCIA / SPAIN

17342

17341

SILLA GIRATORIA TAMARA  
SWIVEL CHAIR TAMARA  
CHAISE PIVOTANT TAMARA

EAN Code 8435178327727

EAN Code 8435178327758

 x1  
2PCS/1CTN

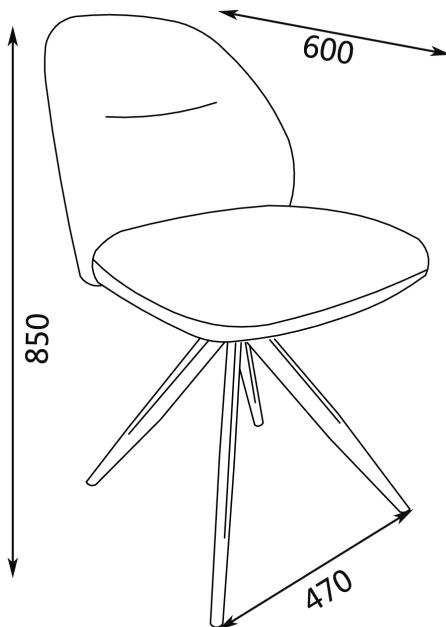

\*À MONTER SOI-MÊME\*

| Tamaño de la caja<br>Dimensions colis<br>Carton dimensions | Peso bruto<br>Poids brut<br>Gross weight | Peso neto<br>Poids net<br>Net weight |
|--|--|--------------------------------------|
| 77 x 51 x 57 (CM)  | 17.5 KG                                  | 14.8 KG                              |

*AVANT DE COMMENCER, SE  
REPORTER AUX CONSEILS  
DE MONTAGE EN ANNEXE*

**BEFORE STARTING, REFER  
TO THE ASSEMBLING ADVICE  
IN ANNEX**

*VOR DER MONTAGE,  
BEILIEGENDE ANWEISUNGEN  
BEFOLGEN.*

*PRIMA DI COMINCIARE  
LEGGETE LE ISTRUZIONI DI  
MONTAGGIO*

*ANTES DE COMERÇAR, ADIAR  
SE AOS CONSELHOS DE  
MONTAGEM EM ANEXO*

**ANTES DE EMPEZAR  
CONSULTE LOS CONSEJOS  
PARA EL MONTAJE**

*PRIJE MONTIRANJA OVOG  
ARTIKLA, MOLIMO PROU  
ČITE PRILO ŽENE UPUTE  
ZA MONTAŽU*

**BASLAMADAN ÖNCE,  
EKTEKI MONTAJ TALIMATLARINI  
İNCELEYİNİZ**

\*IMPORTANT: À CONSERVER POUR RÉFÉRENCE ULTÉRIEURE - LIRE ATTENTIVEMENT

\*ATTENTION: NE PAS UTILISER SI UNE PARTIE EST CASSÉE, ENDOMMAGÉE OU MANQUANTE

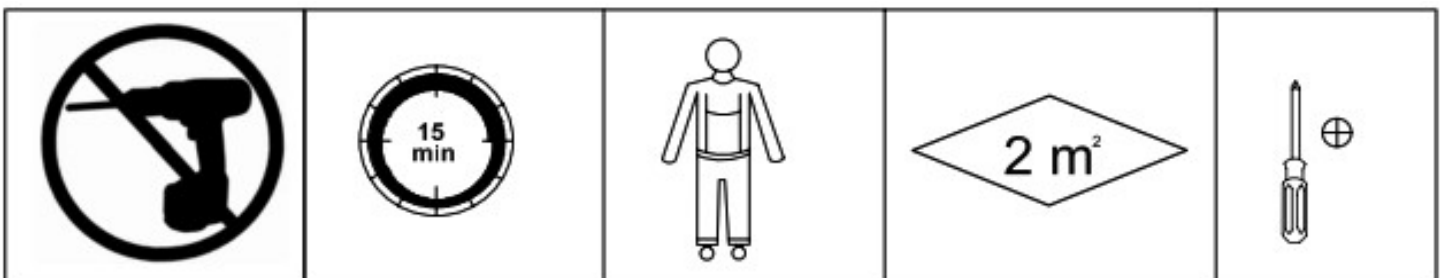

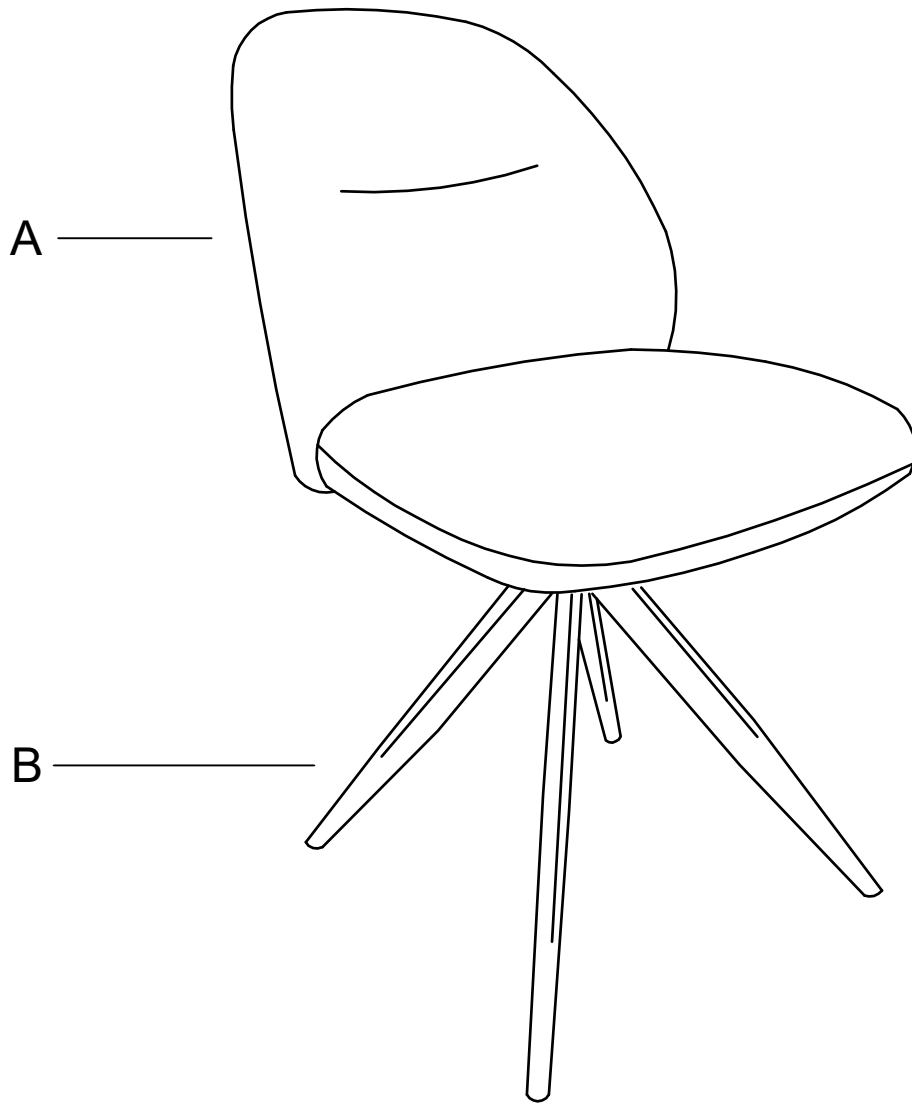

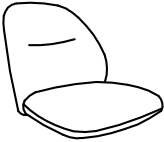
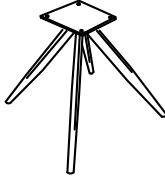

LISTADO DE PIEZAS  
 COMPOSANTS  
 PARTS LIST

|   |   |      |   |   |      |  |  |  |
|---|---|------|---|---|------|--|--|--|
| A |  | 1 PC | B |  | 1 PC |  |  |  |
|   |   |      |   |   |      |  |  |  |

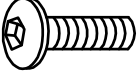
HERRAJES  
 QUINCALLERIE  
 HARDWARE

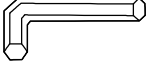
|   |  |       |   |   |       |   |   |       |
|---|--|-------|---|---|-------|---|---|-------|
| C | <br>M6x16mm | 4 PCS | D | <br>M6 | 4 PCS | E |  | 1 PCS |
|   |  |       |   |   |       |   |   |       |

# STEP 1/ ETAPE 1

SPANISH:  
En caso de reclamación,  
por favor, facilitar la  
información escrita en la  
etiqueta.

FRENCH:  
En cas de réclamation,  
merci de transmettre les  
informations contenues sur  
l'étiquette fixée sur le  
produit.

ENGLISH :  
If you may have whatever  
complaint, please, let us  
know the information  
written on the label.

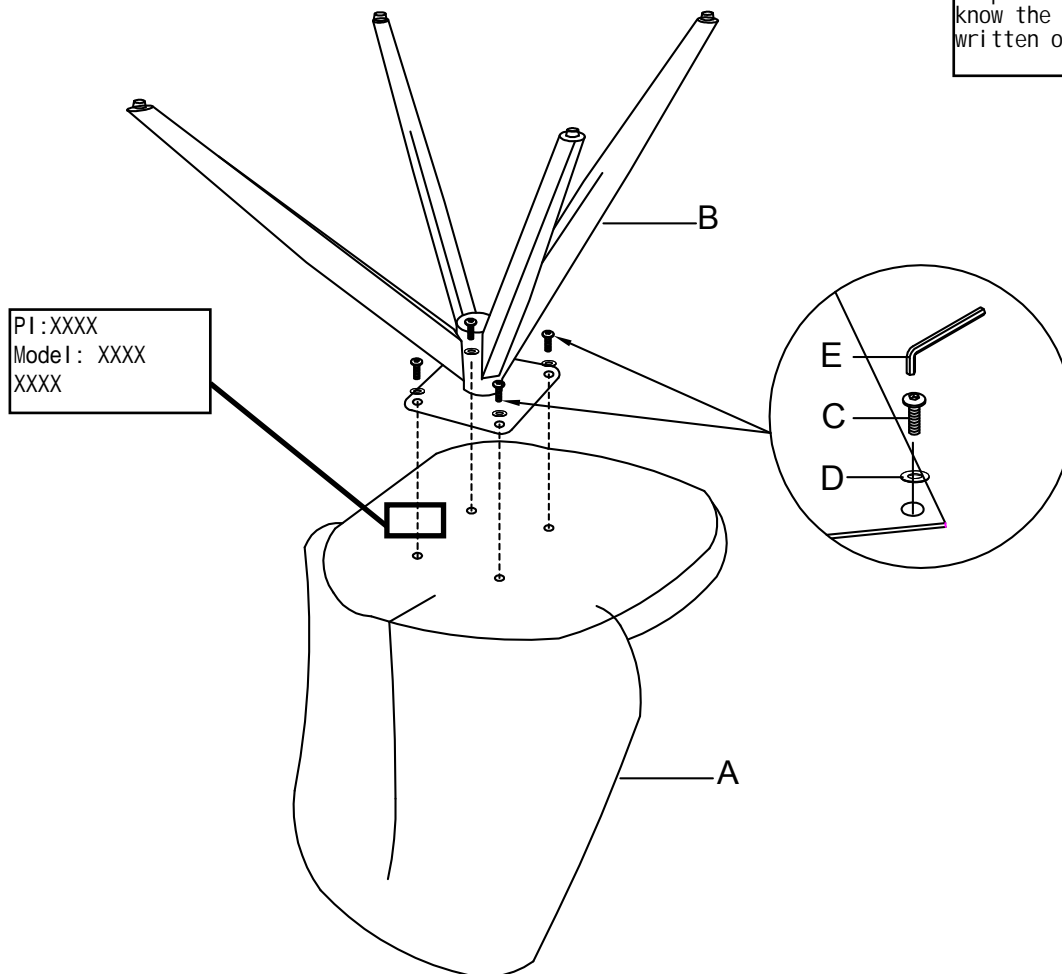
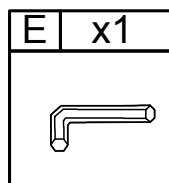
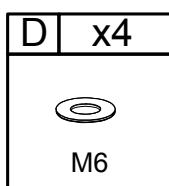
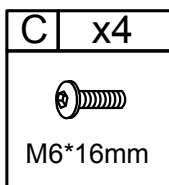
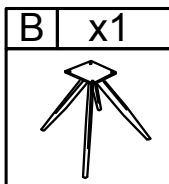
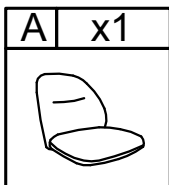

PRODUIT MONTÉ



## FRANCAIS - SUISSE

### CONSEILS DE MONTAGE :

- 1 > BIEN ETUDIER LA NOTICE DE MONTAGE.
- 2 > REPEREZ LES PIÈCES CONSTITUANT VOTRE MEUBLE.
- 3 > REGROUPEZ ET CONTROLEZ LA QUINCAILLERIE.
- 4 > MUNISSEZ-VOUS DE L'OUTILLAGE NECESSAIRE.
- 5 > AMENAGEZ-VOUS UNE ZONE DE MONTAGE.
- 6 > PROCEDEZ AU MONTAGE.



**NE JAMAIS FORCER LES ASSEMBLAGES.  
RESSERREZ LES VIS APRES QUELQUES TEMPS D'USAGE.  
GARDER VOTRE NOTICE DE MONTAGE, SI UNE PIÈCE  
VENAIT A MANQUER, ELLE SERAIT LE PLUS CLAIR  
MOYEN DE COMMUNIQUER AVEC VOTRE MAGASIN.**

### CONSEILS D'ENTRETIEN :

- 1 > DÉPOUSSIÉREZ SOIGNEUSEMENT.
- 2 > UTILISEZ UN CHIFFON SEC.



**- NE JAMAIS UTILISER  
DE PRODUITS ABRASIFS:  
POUDRE, LAINE D'ACIER, SOLVANTS.  
- NE PAS MOUILLER**

|                                | PAPIER<br>DECOR | SURFACES<br>STRATIFIÉES | SURFACES<br>LAQUÉES | BOIS<br>VERNIS | TEXTILE<br>CUIR |
|--------------------------------|-----------------|-------------------------|---------------------|----------------|-----------------|
| EAU SAVONNEUSE (SAVON NEUTRE)  | ○               | ○                       | ○                   | ○              | ○               |
| EAU ADDITIO NÉE                |                 | ○                       | ○                   |                |                 |
| ENTRETIEN SPÉCIFIQUE FABRICANT |                 |                         |                     |                | ○               |

## DEUTSCH - SCHWEIZ

### MONTAGE ANLEITUNG:

- 1 > DIE MONTAGEANLEITUNG SORGFÄLTIG DURCHLESEN.
- 2 > DIE EINZELTEILE DES MÖBELSTÜCKS ERMITTELN.
- 3 > DIE BESCHLÄGE ZUSAMMENLEGEN UND PRÜFEN.
- 4 > DAS NOTWENDIGE WERKZEUG ZURECHTLEGEN.
- 5 > EINEN MONTAGEBEREICH FREIMACHEN.
- 6 > DAS MÖBELSTÜCK ZUSAMMENBAUEN.



**NIEMALS DIE VERBINDUNGEN ZU STARK ANZIEHEN.  
DIE SCHRAUBEN NACH EINIGER ZEIT DES GEBRAUCHS  
ERNEUT FESTZIEHEN. DIE MONTAGEANLEITUNG  
GUT AUFBEWAHREN: SOLLTE EIN TEIL FEHLEN, IST SIE DAS  
BESTE VERSTÄNDIGUNGSMITTEL MIT IHREM GESCHÄFT.**

### PFLEGEHINWEISE :

- 1 > SORGFÄLTIG ENTSTAUBEN.
- 2 > VERWENDEN SIE EIN TROCKENES TUCH.



**- BENUTZEN SIE KEINE  
SCHEUERMITTEL WIE PULVER,  
STAHLWOLLE, LÖSUNGSMITTEL.  
- KEIN WASSER VERWENDEN.**

|                                  | DEKORPAPIER | OBERFLÄCHE<br>LAMINAT | OBERFLÄCHE<br>LACK | LACKIERTEM<br>HOLZ | TEXTIL<br>LEDER |
|----------------------------------|-------------|-----------------------|--------------------|--------------------|-----------------|
| SEIFENLAUGE (NEUTRALSEIFE)       | ○           | ○                     | ○                  | ○                  | ○               |
| WASSER MIT HAUSHALTSRFINIGER     |             | ○                     | ○                  |                    |                 |
| PRODUZENT SPEZIFISCHER UNTERHALT |             |                       |                    |                    | ○               |

## ITALIANO - SVIZZERA

### CONSIGLI DI MONTAGGIO

- 1 > STUDIARE BENE LE ISTRUZIONI DI MONTAGGIO.
- 2 > PRENDERE CONOSCENZA DEI PEZZI CHE COSTITUISCONO IL MOBILE.
- 3 > RAGGRUPPARE E CONTROLLARE LA FERRAMENTA.
- 4 > MUNIRSI DEGLI UTENSILI NECESSARI.
- 5 > PREPARARE UNA ZONA DI MONTAGGIO.
- 6 > PROCEDERE AL MONTAGGIO.



**NON FORZARE MAI GLI ASSEMBLAGGI  
RISTRINGERE LE VITI DOPO UN PERIODO D'USO  
CONSERVARE QUESTE ISTRUZIONI DI MONTAGGIO,  
SE UN PEZZO VENISSE A MANCARE SAREBBE IL MIGLIORE  
MEZZO DI COMUNICAZIONE CON IL RIVENDITORE**

### CONSIGLI PER LA MANUTENZIONE :

- 1 > SPOLVERATE ACCURATAMENTE.
- 2 > USARE UN PANNINO ASCIUTTO.



**- NON UTILIZZARE MAI PRODOTTI  
ABRASIVI: POLVERE,  
LANA DI ACCIAIO, SOLVENTI.  
- NON BAGNARE.**

|                                   | CARTA | SUPERFICIE<br>STRATIFICATE | SUPERFICIE<br>LACCATE | LACCATE EGNO<br>VERNICIATO | TESSILE<br>CUOIO |
|-----------------------------------|-------|----------------------------|-----------------------|----------------------------|------------------|
| ACQUA CON SAPONE (SAPONE NEUTRO)  | ○     | ○                          | ○                     | ○                          | ○                |
| ACQUA CON DETERSIVO SAN MARC      |       | ○                          | ○                     |                            |                  |
| MANUTENZIONE SPECIFICA PRODUTTORE |       |                            |                       |                            | ○                |

## PORTUGUÊS

### CONSELHOS DE MONTAGEM:

- 1 > ESTUDE BEM AS INSTRUÇÕES DE MONTAGEM.
- 2 > REUNA AS PEÇAS QUE CONSTITUEM O SEU MÓVEL.
- 3 > REAGRUPE AS FERRAGENS.
- 4 > EQUIPE-SE COM AS FERRAMENTAS NECESSÁRIAS.
- 5 > PREPARE UMA ÁREA PARA A MONTAGEM.
- 6 > INICIE A MONTAGEM.



**NUNCA FORÇAR OS ENCAIXES.**  
REAPERTAR OS PARAFUSOS APÓS UM TEMPO DE UTILIZAÇÃO.  
GUARDAR AS INSTRUÇÕES DE MONTAGEM.  
CASO FALTE ALGUMA PEÇA, O MAIS ACONSELHÁVEL  
É CONTATAR O REVENDEDOR.

### CONSELHOS PARA A MANUTENÇÃO :

- 1 > ELIMINAR BEM O PÓ.
- 2 > USAR PAÑO SECO.



- **NUNCA UTILIZAR PRODUTOS ABRASIVOS: SAPONÁCEOS, LÃ DE AÇO, SOLVENTES.**  
- NÃO MOLHAR ,

|                                      | ACABAMENTO<br>IMITAÇÃO | SUPERFÍCIES<br>ESTRATIFICADAS | SUPERFÍCIES<br>LACADAS | MADEIRA<br>ENVERNIZADA | TEXTEIS<br>PELES      |
|--------------------------------------|------------------------|-------------------------------|------------------------|------------------------|-----------------------|
| ÁGUA COM SABÃO (SABÃO NEUTRO)        | <input type="radio"/>  | <input type="radio"/>         | <input type="radio"/>  | <input type="radio"/>  | <input type="radio"/> |
| ÁGUA COM DETERGENTE                  |                        | <input type="radio"/>         | <input type="radio"/>  |                        |                       |
| INSTRUÇÕES ESPECÍFICAS DO FABRICANTE |                        |                               |                        |                        | <input type="radio"/> |

## ESPAÑOL

### CONSEJOS PARA EL MONTAJE:

- 1 > ESTUDIE ATENTAMENTE EL MANUAL DE MONTAJE.
- 2 > LOCALICE LAS PIEZAS QUE CONSTITUYEN SU MUEBLE.
- 3 > REUNA Y CONTROLE LOS TORNILLOS.
- 4 > EQUIPE-SE DE LAS HERRAMIENTAS NECESARIAS.
- 5 > PREPARE UNA ZONA DE MONTAJE.
- 6 > REALICE EL MONTAJE.



**NO FUERCE NUNCA EN LAS UNIONES. APRIETE LOS TORNILLOS DESPUES DE CIERTO TIEMPO DE UTILIZACION**  
CONSERVE SU MANUAL DE MONTAJE,  
SI FALTARA UNA PIEZA, SERIA LA MANERA  
MAS FACIL DE COMUNICAR CON LA TIENDA.

### CONSEJOS PARA EL MANTENIMIENTO:

- 1 > DESPOLVOREAR CULDADOSAMENTE.
- 2 > UTILICE UN PAÑO SECO.



- **NO USE NUNCA PRODUCTOS ABRASIVOS TALES COMO: POLVO DE LIMPIAR, LANA DE ACERO, SOLVENTES.**  
- NO MOJAR.

|   | PAPEL DE<br>DECORACION | SUPERFICIE<br>ESTRATIFICADAS | SUPERFICIE<br>MAQUEADAS | MADERA<br>BARNIZADA   | TEXULL<br>CUERO       |
|---|------------------------|------------------------------|-------------------------|-----------------------|-----------------------|
| AGUA Y JABON (JABON NEUTRO)             | <input type="radio"/>  | <input type="radio"/>        | <input type="radio"/>   | <input type="radio"/> | <input type="radio"/> |
| AGUA COM DETERGENTE                     |                        | <input type="radio"/>        | <input type="radio"/>   |                       |                       |
| MANTENIMIENTO ESPECIFICO DEL FABRICANTE |                        |                              |                         |                       | <input type="radio"/> |

## HRVATSKA

### UPUTE ZA MONTAŽU:

- 1 > PAŽLJIVO PROČITAJTE UPUTE ZA MONTAŽU.
- 2 > PRIPREMITE SVE DIJELOVE NAMJEŠTAJA.
- 3 > PRIKUPITE I PROVJERITE OKOVE ZA MONTAŽU.
- 4 > PRIPREMITE POTREBAN ALAT.
- 5 > PRIPREMITE PROSTOR ZA MONTAŽU.
- 6 > POČNITE MONTIRATI.



**NEMOJTE UPOTREBLJAVATI SILU PRILIKOM SKLAPANJA**  
NAKON NEKOG VREMENA PONOVRNO PRITEGNIJE VIJKE  
ČUVAJTE UPUTE ZA MONTAŽU  
U SLUČAJU NEDOSTATKA NEKOG DIJELA NAJBOLJE ĆE BITI DA  
DA KONTAKIRATE PRODAJNO MJESTO.

### UPUTE ZA ODRŽAVANJE :

- 1 > PAŽLJIVO OBRISATI PRAŠINU.
- 2 > KORISTITE SUHU KRPU.



- **ZABRANJENA JE UPOTREBA KEMIKALIJA ILI BILO KAKVIH POMOĆNIH SREDSTAVA ZA RIBANJE JAKIH SREDSTAV ZA ČIŠĆENJE ILI ČELIČNE VUNE**  
-NE MOKRA.

|                    | PAPIR                 | LAMINAT               | LAK                   | DRVO                  | TEKSTIL/<br>KOŽA      |
|--------------------|-----------------------|-----------------------|-----------------------|-----------------------|-----------------------|
| OTPINA SAPUNA      | <input type="radio"/> | <input type="radio"/> | <input type="radio"/> | <input type="radio"/> | <input type="radio"/> |
| OTPINA DETERDŽENTA |                       | <input type="radio"/> | <input type="radio"/> |                       |                       |
| NAMJENSKA SREDSTVA |                       |                       |                       |                       | <input type="radio"/> |

## TÜRKÇE

### MONTAJ TALİMATLARI:

- 1 > Montaj tanıtım yazısını dikkatlice okuyunuz.
- 2 > Mobilyanızı oluşturan parçaları işaretleyiniz.
- 3 > Hırdavatla ilgili parçaları bir araya toplayıp; kontrol ediniz.
- 4 > Gereken araç ve gereci tedarik ediniz.
- 5 > (Kendinize) Bir montaj alanı edininiz.
- 6 > Monte etmeye başlayınız.



**MONTAJLARI ZORLAMAYINIZ.**  
BİRKAÇ KULLANIMDAN SONRA VİDALARI SIKIŞTIRINIZ.  
BİR PARÇANIN KAYBOLMASI DURUMUNDA MAĞAZANIZLADAHA  
KOLAY İLETİŞİME GEÇEBİLMENİZ İÇİN MONTAJ KULLANIM  
TALİMATINIZI SAKLAYINIZ.

### BAKIM TALİMATLARI:

- 1 > TOZUNU DİKKATLİCE ALINIZ.
- 2 > YUMUŞAK BİR BEZİ TEMİZ SU VE AZ MİKTARDA SABUNLA(DETERJAN) NEMLENDİRİNİZ.



- ASLA AŞINDIRICI ÜRÜNLER  
KULLANMAYINIZ : ÇELİK YÜNÜ,  
SOLVENT...  
- BOL SUYLA YIKAMAYINIZ.

|                         | SÜS<br>KAĞIDI | KATMAN<br>YÜZEY | LAKE<br>YÜZEY | ÇİRALI<br>TAHTA | TEKSTİL<br>DERİ |
|-------------------------|---------------|-----------------|---------------|-----------------|-----------------|
| SABUNLU SU (NÖTR SABUN) | ○             | ○               | ○             | ○               | ○               |
| DETERJAN KATILMIŞ SU    |               | ○               | ○             |                 |                 |
| ÜRETİCİYE ÖZGÜ BAKIM    |               |                 |               |                 | ○               |

## ENGLISH

### ASSEMBLY ADVICE :

- 1 > CAREFULLY READ THE ASSEMBLY INSTRUCTION.
- 2 > IDENTIFY THE COMPONENTS OF THE FURNITURE.
- 3 > GROUP AND CHECK THE HARDWARE.
- 4 > USE THE REQUIRED TOOLS.
- 5 > CREATE AN ASSEMBLY ZONE.
- 6 > MAKE THE ASSEMBLY.



**NEVER FORCE THE CONNECTIONS.**  
RE-TIGHTEN THE SCREWS AFTER FEW DAYS.  
PLEASE RETAIN THE AI LEAFLET FOR FUTURE REFERENCE,  
THE AI CONTAINS INFORMATION WHEN CLAIMING  
FOR MISSING PARTS.

### CLEANING ADVICE:

- 1 > CAREFULLY REMOVE THE DUST.
- 2 > USE A SOFT, CLEAN DAMP CLOTH WITH SOAPY WATER.



**NEVER USE ABRASIVE PRODUCTS  
OR SOLVENTS.**  
DO NOT APPLY EXCESSIVE PRESSURE  
WHEN USING THE DAMP CLOTH.

|                            | PAPER DECOR | LAMINATED<br>SURFACES | LACQUERED<br>SURFACE | VARNISHED<br>WOOD | LEATHER<br>TEXTILE |
|----------------------------|-------------|-----------------------|----------------------|-------------------|--------------------|
| SOAPY WATER (NEUTRAL SOAP) | ○           | ○                     | ○                    | ○                 | ○                  |
| WATER WITH DETERGENT       |             | ○                     | ○                    |                   |                    |
| SPECIFIC SUPPLIER CLEANING |             |                       |                      |                   | ○                  |



**LE TRI  
+ FACILE**



**BAC  
DE TRI**



FR

**Donnez ou recyclez  
vos meubles.**



Association

ou



Magasin

ou



Déchèterie

<https://quefairedemesdechets.fr>