

AUFBAUANLEITUNG | ASSEMBLY INSTRUCTION

BAUTEILE | CONSTRUCTION PARTS

Artikelnr.: 45679

Hersteller | Manufacturer: Invicta Interior GmbH & Co KG - Kirchenweg 8, 24568 Nützen - info@invicta-interior.com - Tel.: 04101 - 80 40 615

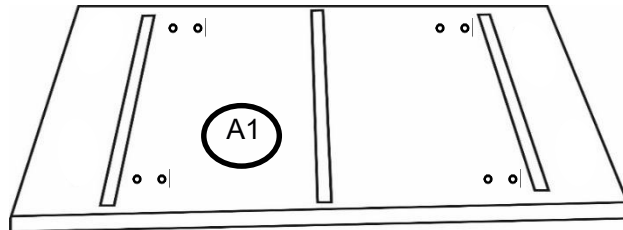
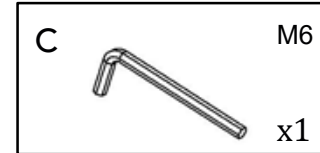
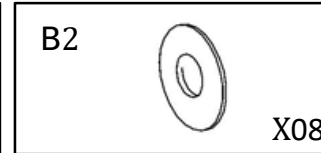
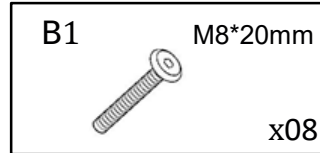
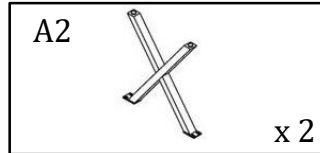
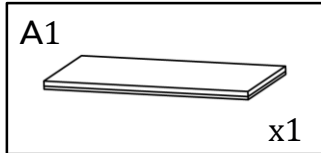

STEP-01

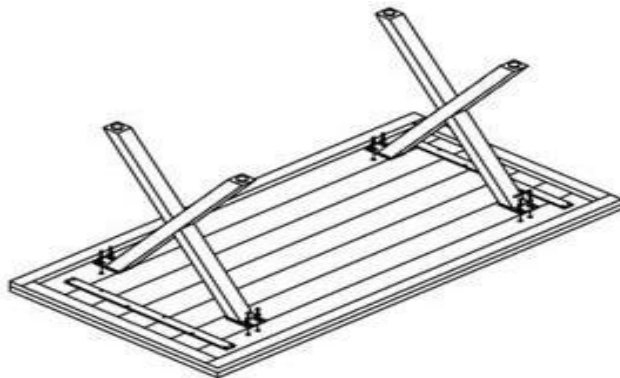

STEP-02

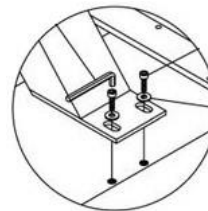

**A1 + A2 +
B1 + B2 + C**

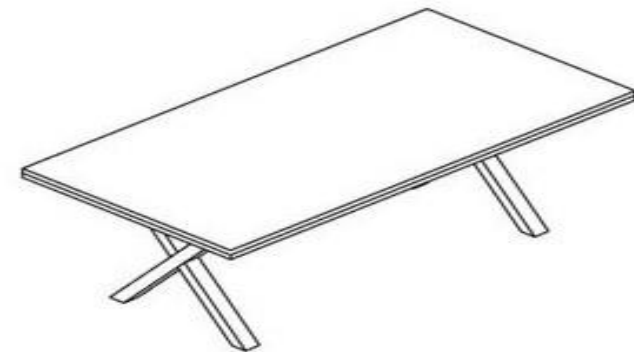

FINAL