

Jennifer

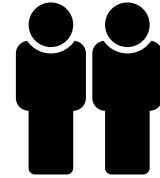

The installation method for a right and left-sided sofa is analogous

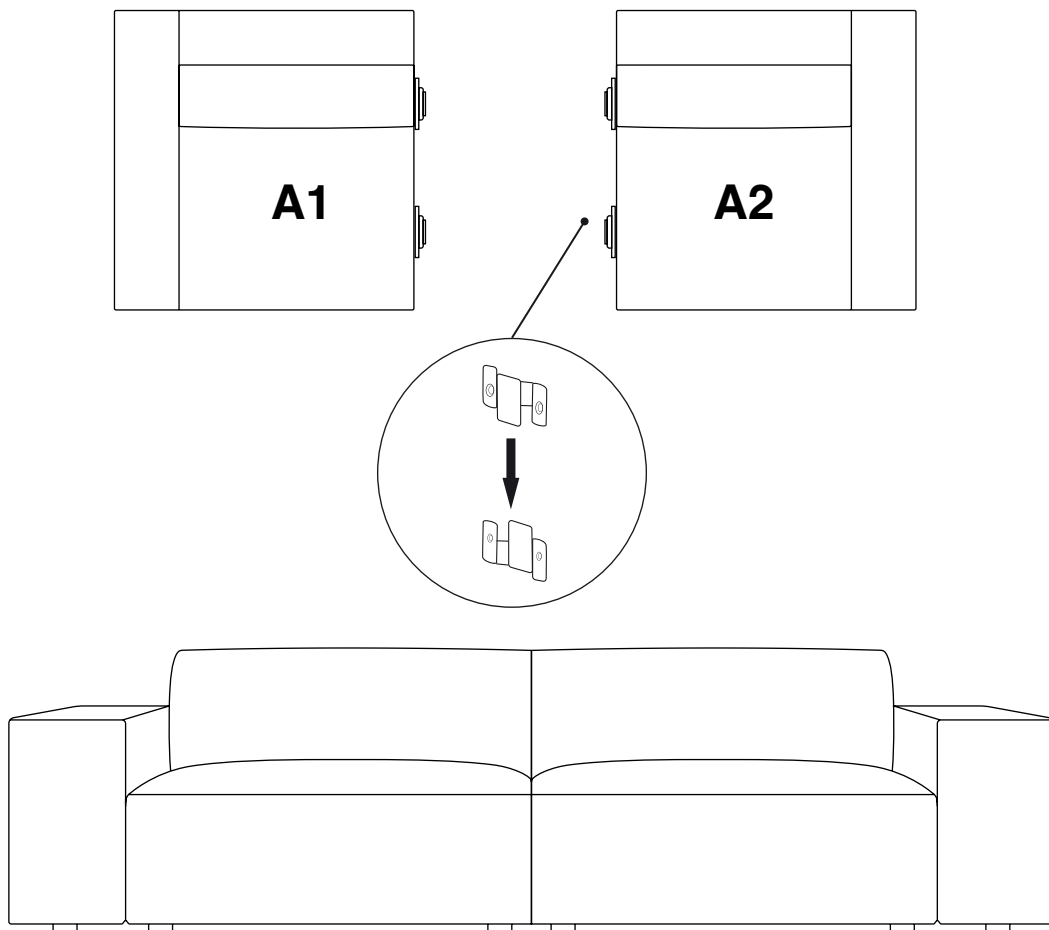

SHAPE UP ALL PILLOWS AND CUSHIONS!

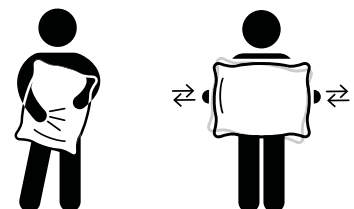

Jennifer

3-seater sofa

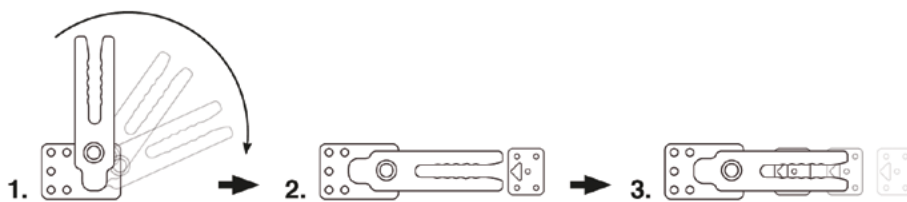
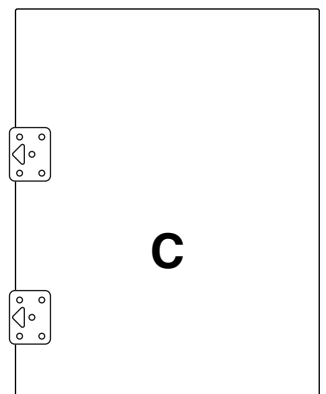
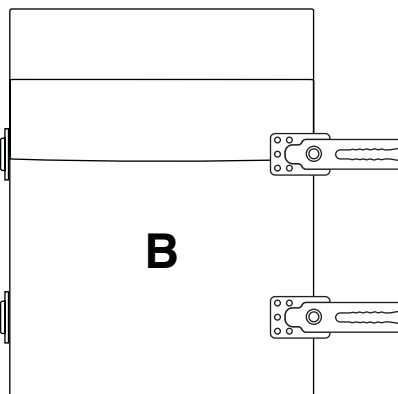
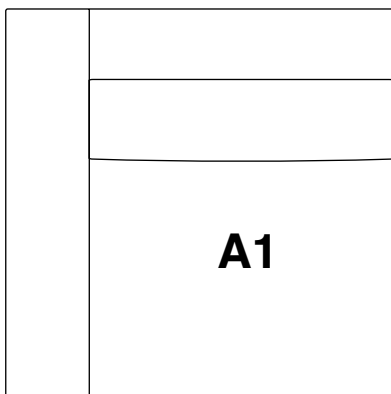
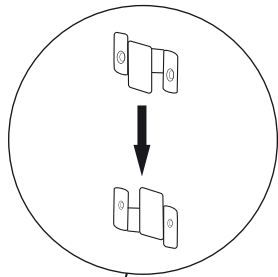
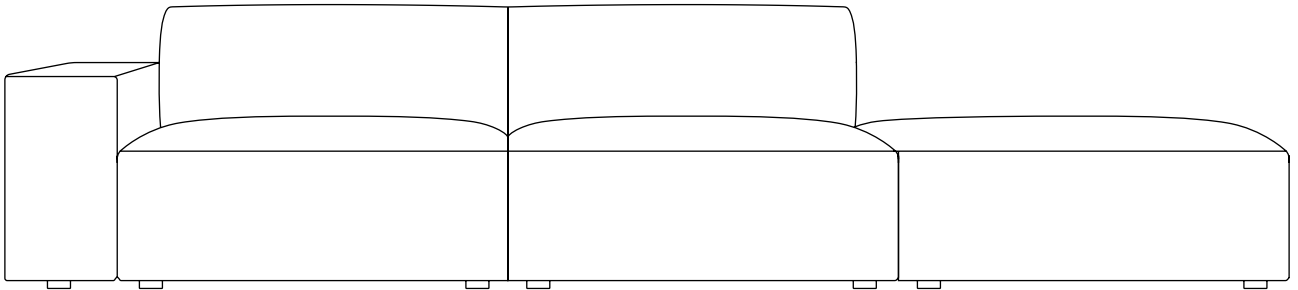
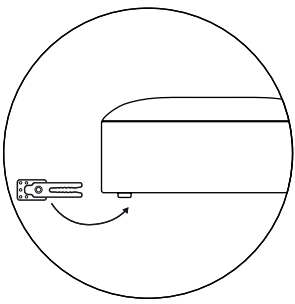

SHAPE UP ALL PILLOWS AND CUSHIONS!

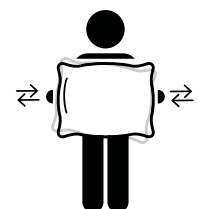

Jennifer

corner sofa

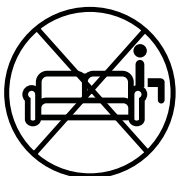
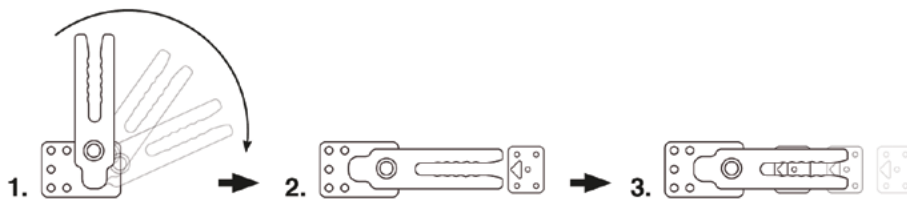
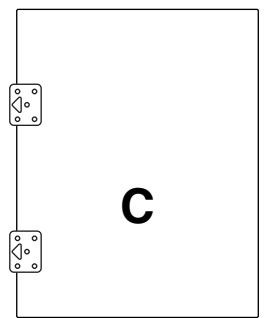
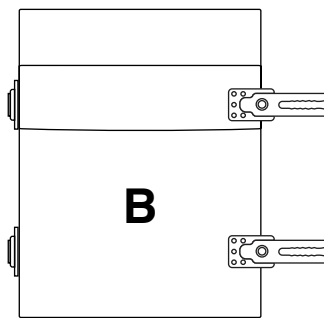
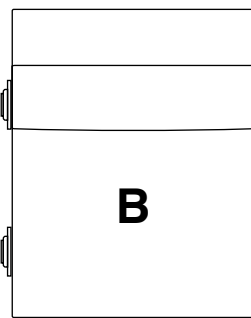
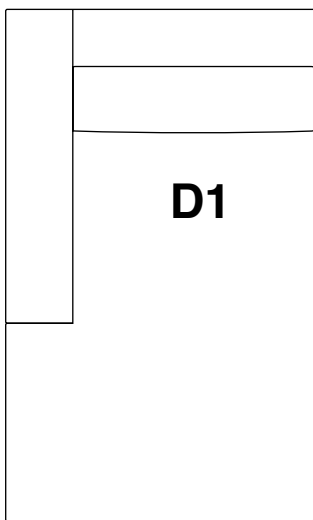
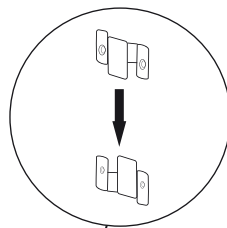
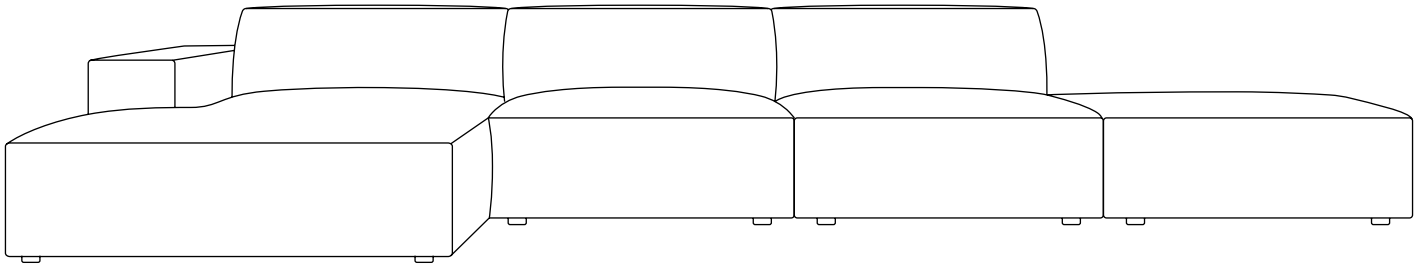
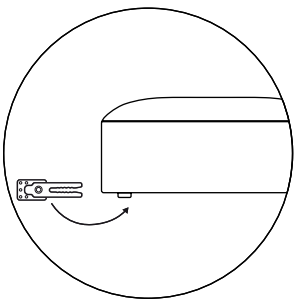

SHAPE UP ALL PILLOWS AND CUSHIONS!

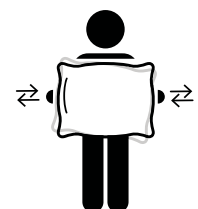

Jennifer

corner sofa

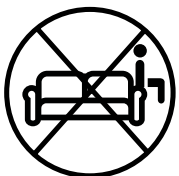
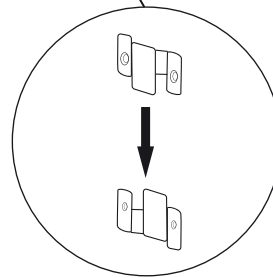
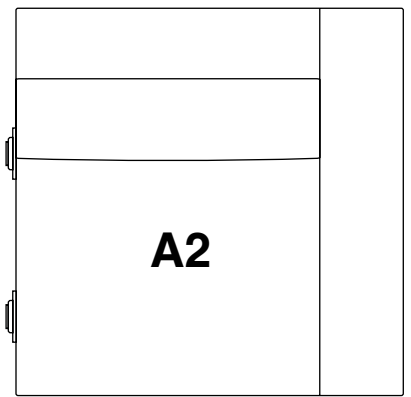
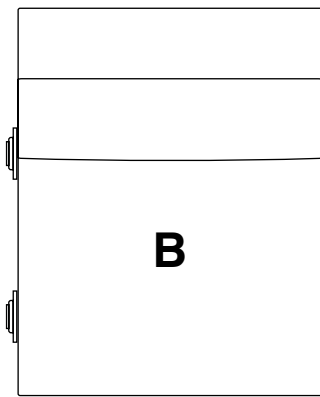
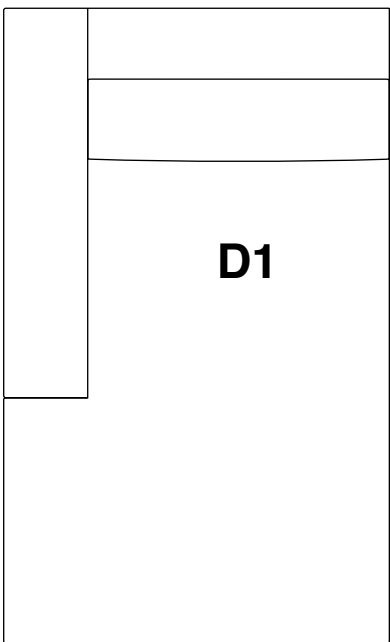
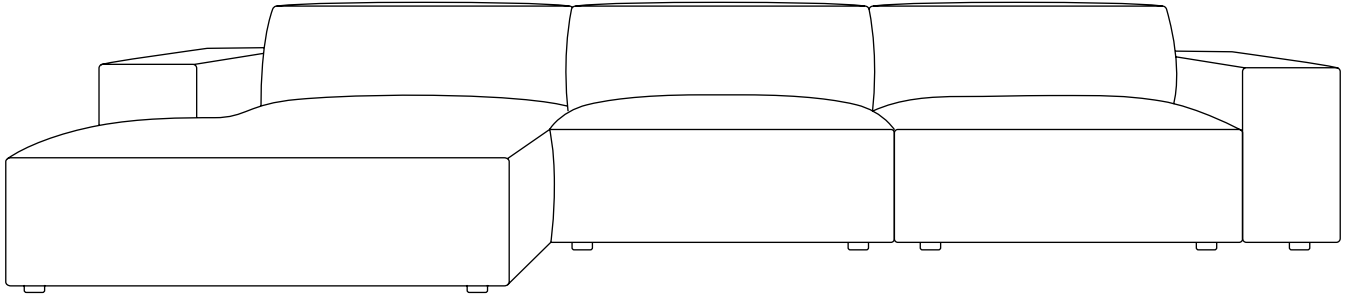
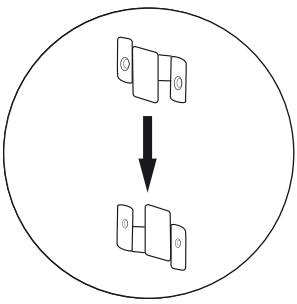

SHAPE UP ALL PILLOWS AND CUSHIONS!

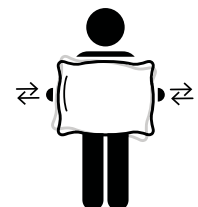

Jennifer

panoramic sofa

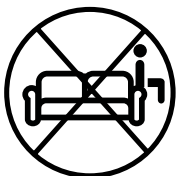
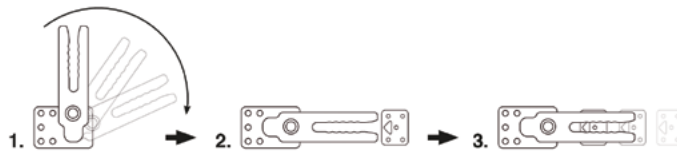
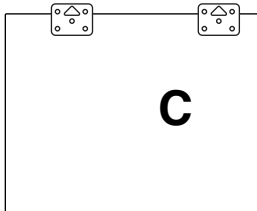
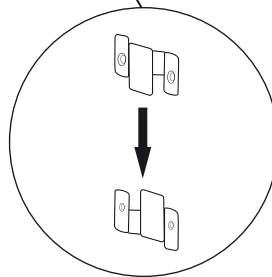
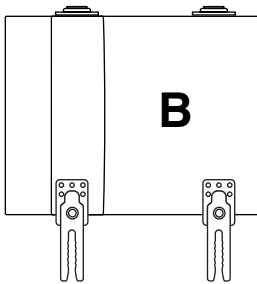
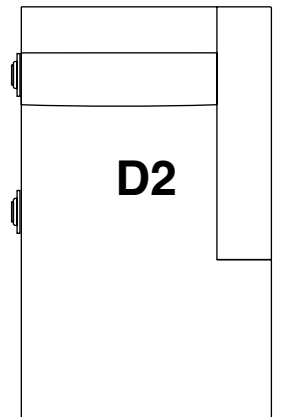
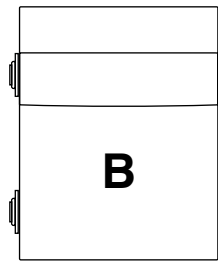
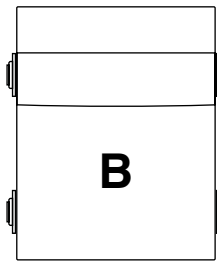
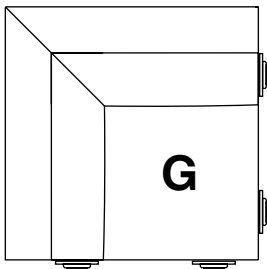
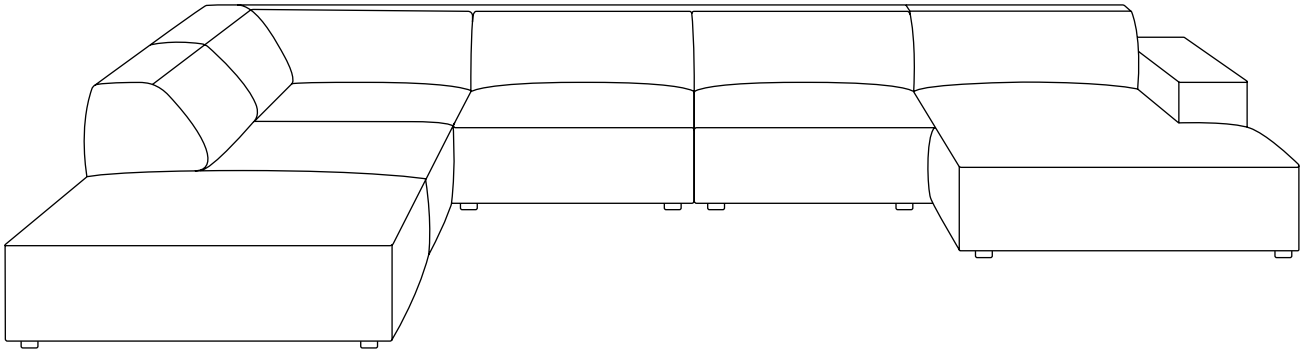
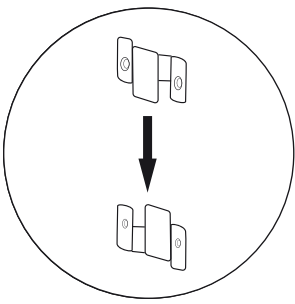

SHAPE UP ALL PILLOWS AND CUSHIONS!

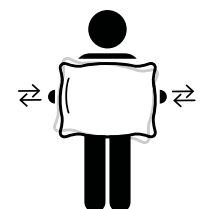

Jennifer

panoramic sofa

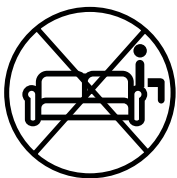
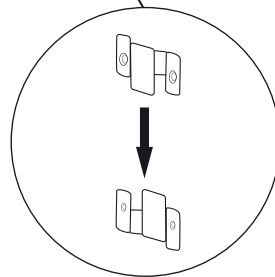
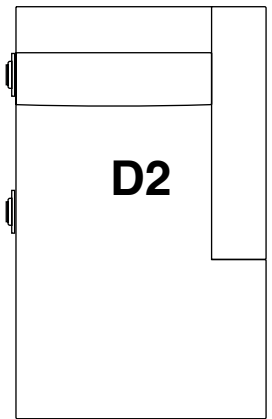
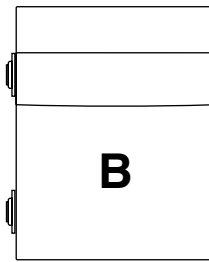
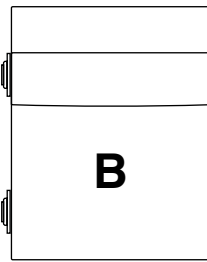
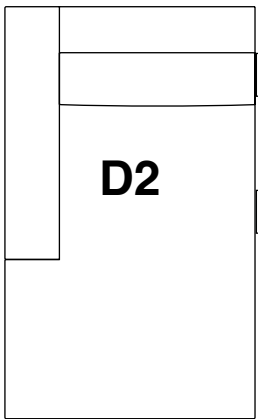
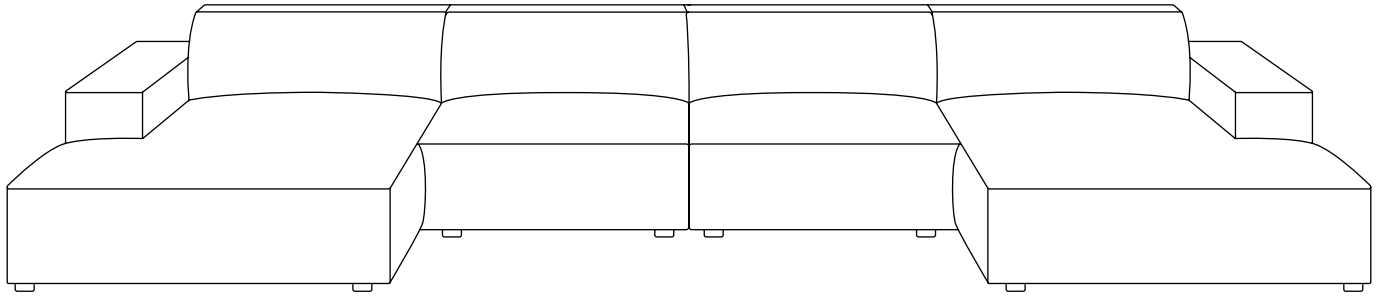
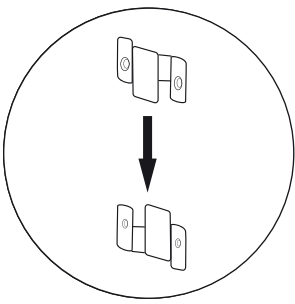

SHAPE UP ALL PILLOWS AND CUSHIONS!

