

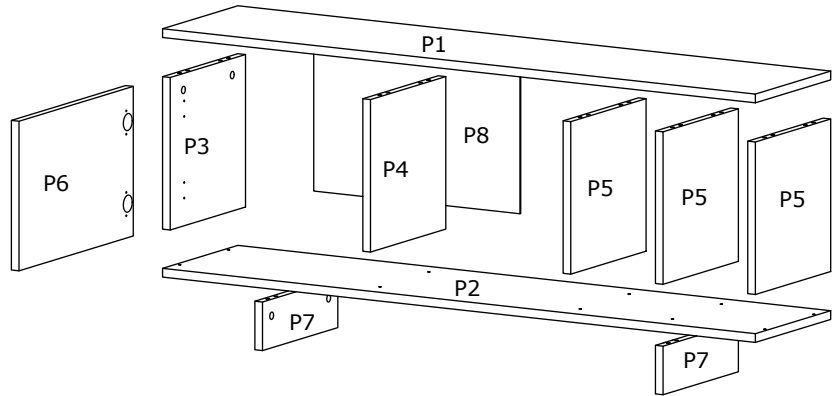

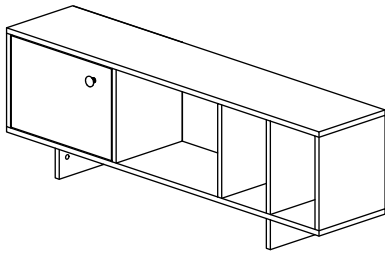







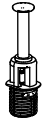

TV STAND

ASSEMBLY INSTRUCTIONS

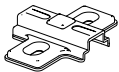

MINIFIX  14 PCS	DUFIX  14 PCS	DOWEL  14 PCS	4*50 SCREW  10 PCS	3,5*18 SCREW  8 PCS	HANDLE  1 PCS
HINGE  2 PCS	HINGE  2 PCS	MINIFIX TAP  14 PCS	SHELF SUPPORT  1 PCS	NAIL  15 PCS	HANDLE SCREW  1 PCS

Dear Customer.

Before reaching this product for purchase, it has been subjected to all tests and controls by us. This line will be moved to be moved to be moved. Training like this back them all don't send it we just don't want the responsible part from us. The missing piece is corrected immediately.

Check all parts and accessories listed in the box before assembly. Your design and accessory is solid Particle then you can start later. Before assembly, wipe a part of it with a damp cloth. It is required for 2 (two) to ensure the installation of this product is solid and secure. It can be installed in approximately 20 to 30 minutes.

If you buy more products, do not start the installation of the other product before the installation of the design is completed in order to avoid any complexity.

Never rub the products by rubbing. Carry 2 (two) people by lifting or removing the products.

If you are going to transport long distances, usually pack it carefully.

For product cleaning, wiping with a damp or soapy cloth or wiping with cleaners will be sufficient.

Do not be directly exposed to this restriction for the reasons of heavy, cold and humidity of the furniture.

Stay away from using your furniture for your purpose.

TV STAND

ASSEMBLY INSTRUCTIONS

STEP 1 :

HANDLE SCREW

3,5*18
SCREW

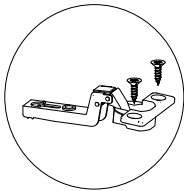
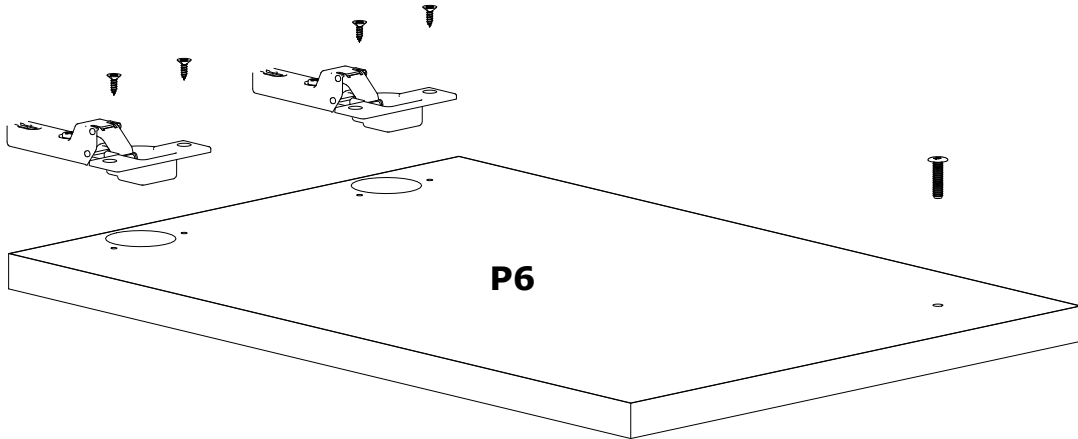

HANDLE

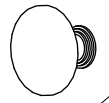

STEP 2 :

3,5*18
SCREW

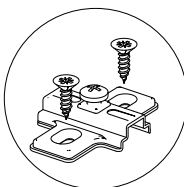
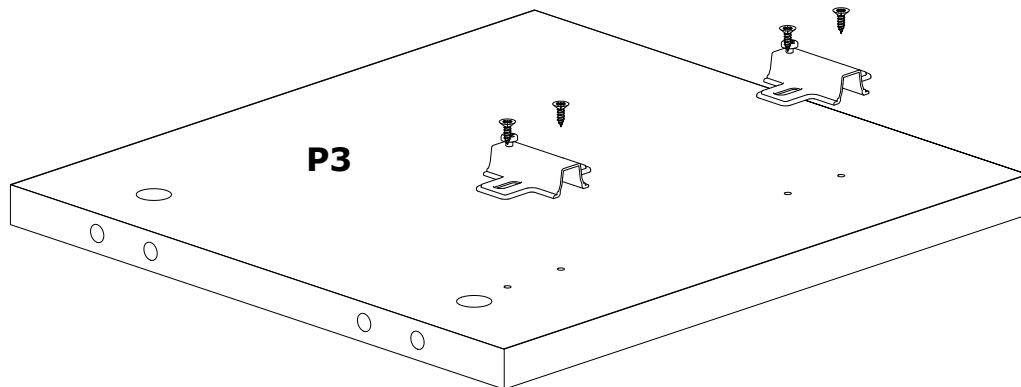

TV STAND

ASSEMBLY INSTRUCTIONS

STEP 3 :

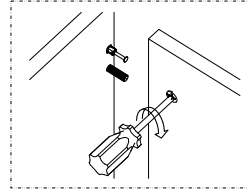
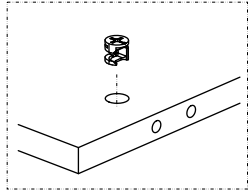
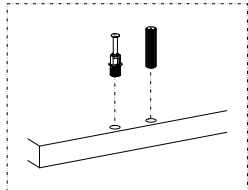
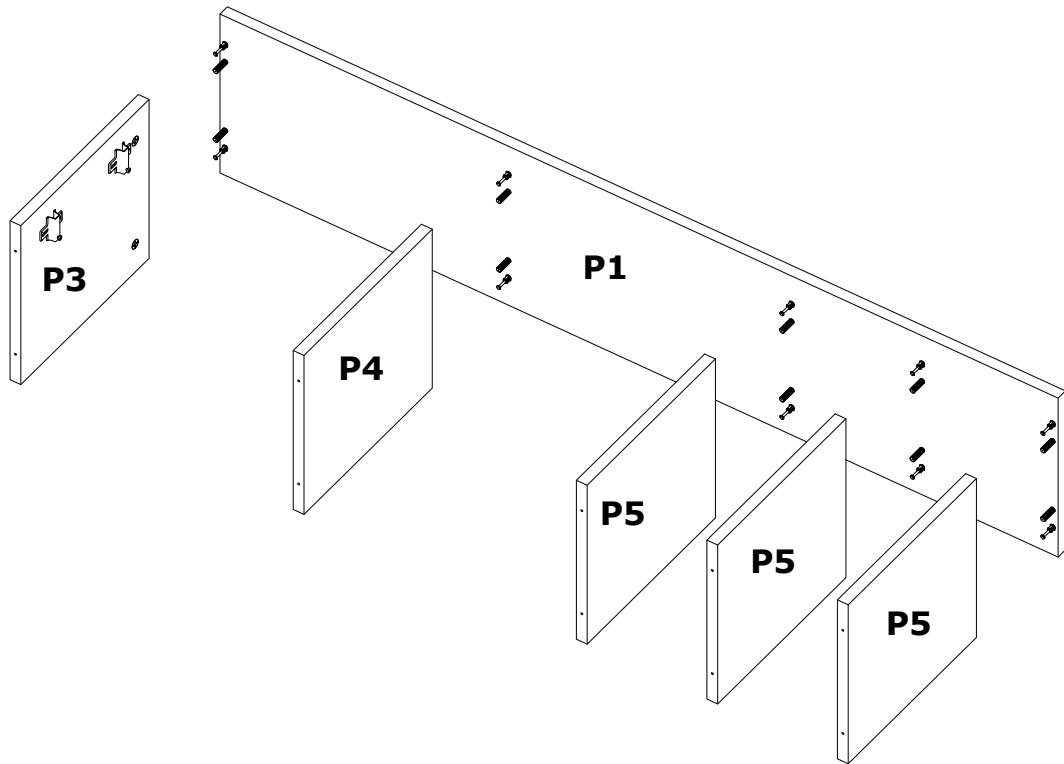

STEP 4 :

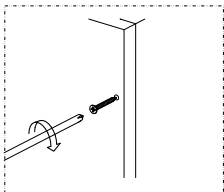
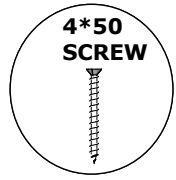
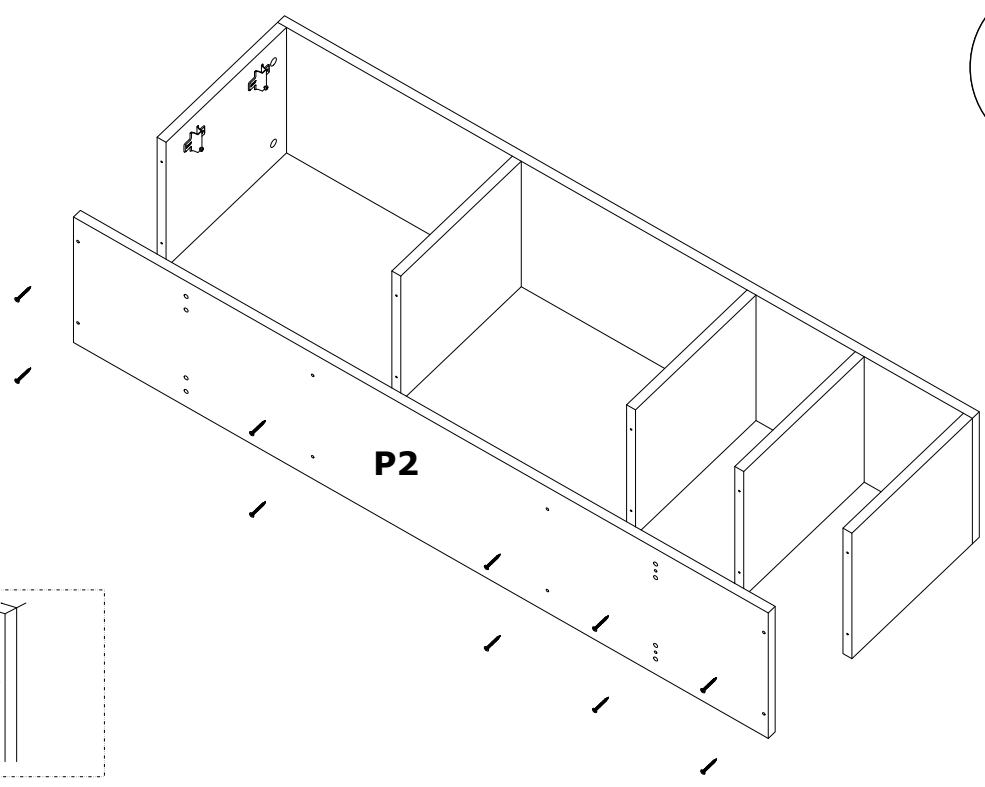

TV STAND

ASSEMBLY INSTRUCTIONS

STEP 5 :

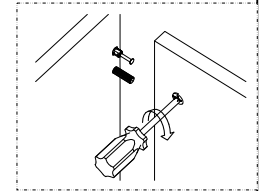
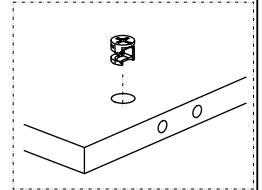
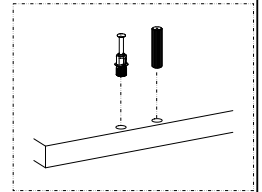
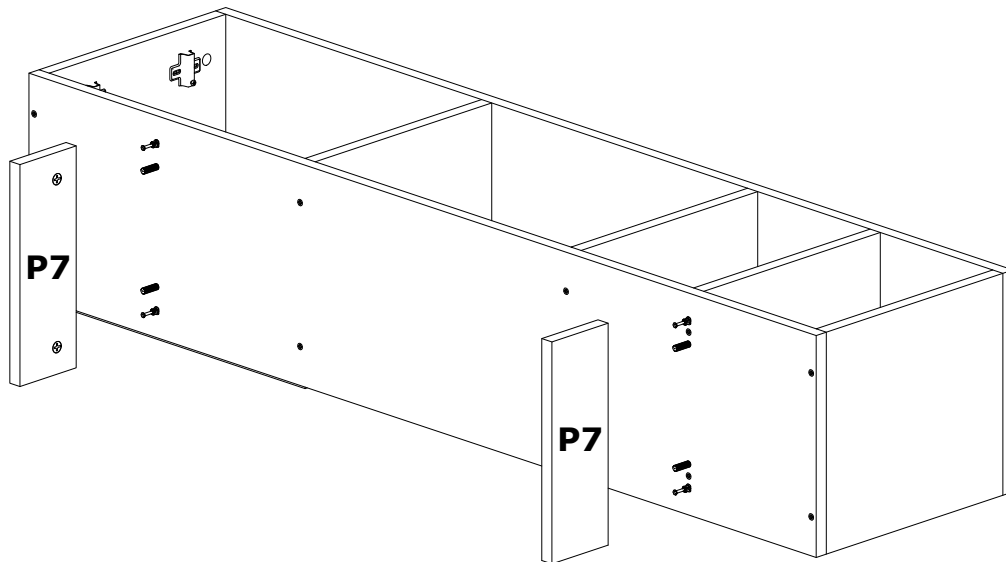

STEP 6 :

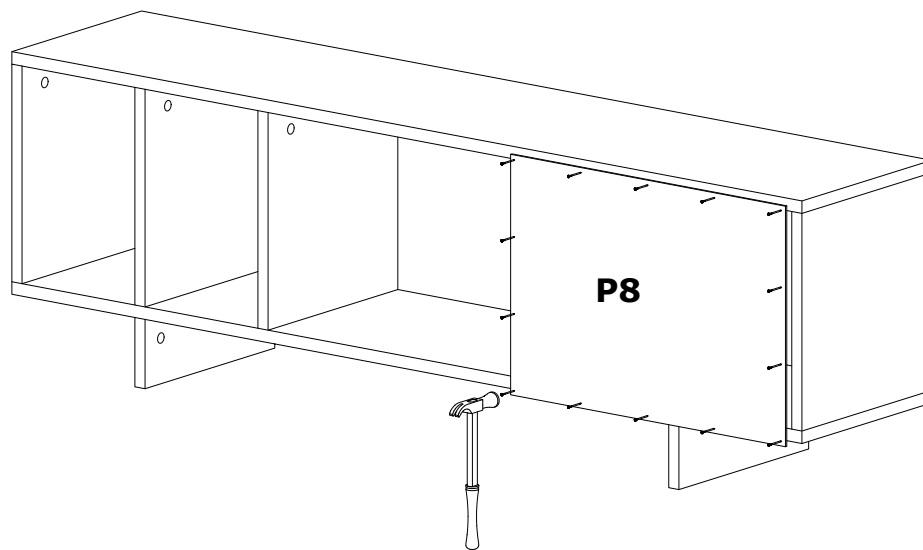

TV STAND

ASSEMBLY INSTRUCTIONS

