

NOTICE DE MONTAGE
ASSEMBLY INSTRUCTIONS
MONTAGEANLEITUNG
ISTRUZIONI DI MONTAGGIO
INSTRUCOES DE MONTAGEM
INSTRUCCIONES DE MONTAJE
UPUTE ZA MONTAZU
MONTAJ TALIMATI

16546

APARADOR KANTU 4P MADERA MANGO
SIDEBOARD KANTU 4D MANGO WOOD
BUFFET KANTU 4P MANGUIER

ME
marckeric

MARCKERIC S.L.
C / ENLACE VEROLA S/N,
PC: 46430/SOLLANA / VALENCIA / SPAIN

EAN CODE 8435178319944

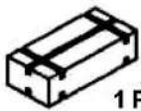
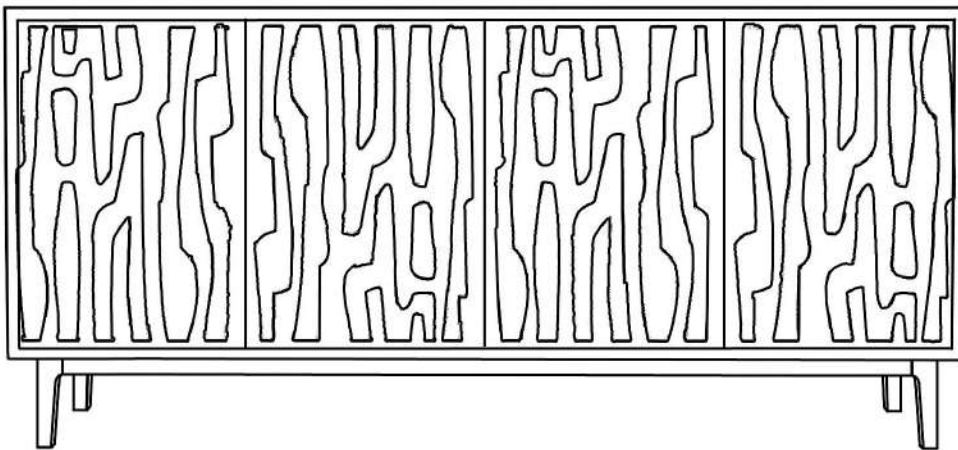

1 PC/1 CTN

À MONTER SOI-MÊME

AVANT DE COMMENCER, SE
REPORTER AUX CONSEILS
DE MONTAGE EN ANNEXE

BEFORE STARTING, REFER
TO THE ASSEMBLING ADVICE
IN ANNEX

VOR DER MONTAGE,
BEILIEGENDE ANWEISUNGEN
BEFOLGEN.

PRIMA DI COMINCIARE
LEGGETE LE ISTRUZIONI DI
MONTAGGIO

ANTES DE COMERÇAR, ADIAR
SE AOS CONSELHOS DE
MONTAGEM EM ANEXO

ANTES DE EMPEZAR
CONSULTE LOS CONSEJOS
PARA EL MONTAJE

PRIJE POÇETKA MONTAŽE
MOLIMO PAŽLJIVO
PROČITAJTE UPUTE ZA
MONTAŽU

BASLAMADAN ÖNCE,
EKTEKI MONTAJ TALIMATLARINI
İNCELEYİNİZ

IMPORTANT: À CONSERVER POUR RÉFÉRENCE ULTÉRIEURE - LIRE ATTENTIVEMENT
ATTENTION: NE PAS UTILISER SI UNE PARTIE EST CASSÉE, ENDOMMAGÉE OU MANQUANTE

Caja Colis Carton	Tamaño de la caja Dimensions colis Carton dimensions	Peso bruto Poids brut Gross weight	Peso neto Poids net Net weight
1/1	1980X480X770MM	68.00 Kg	62.00 Kg

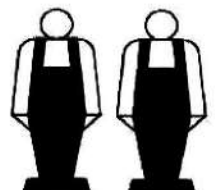
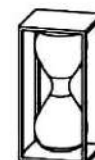
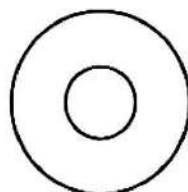

15min.

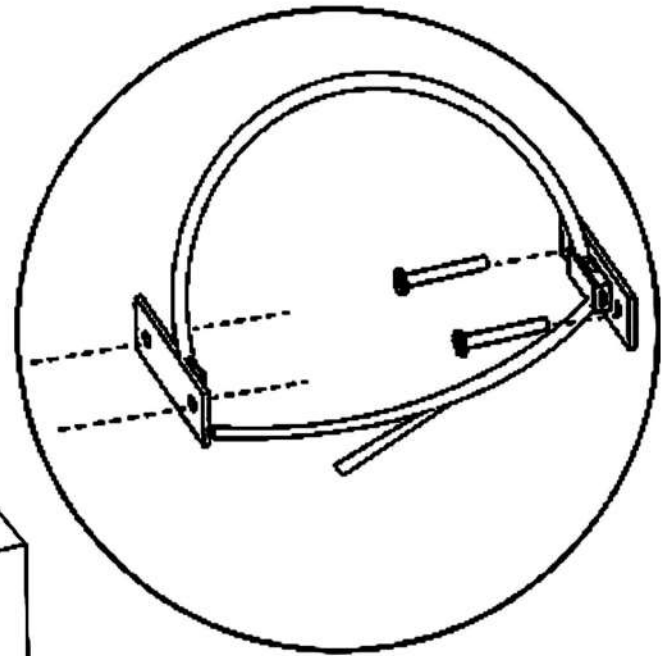
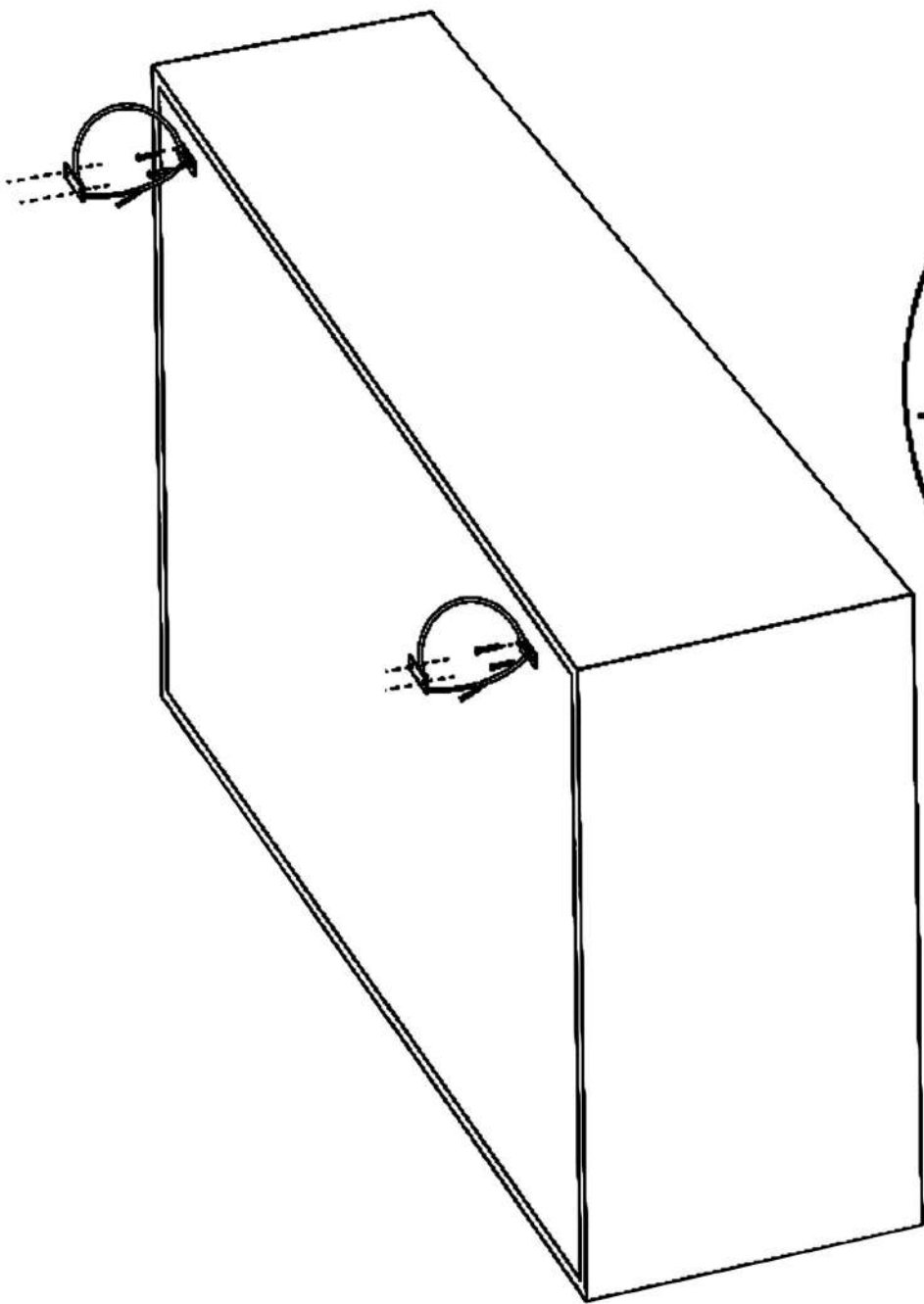

LISTADO DE PIEZAS - COMPOSANTS - PARTS LIST

01

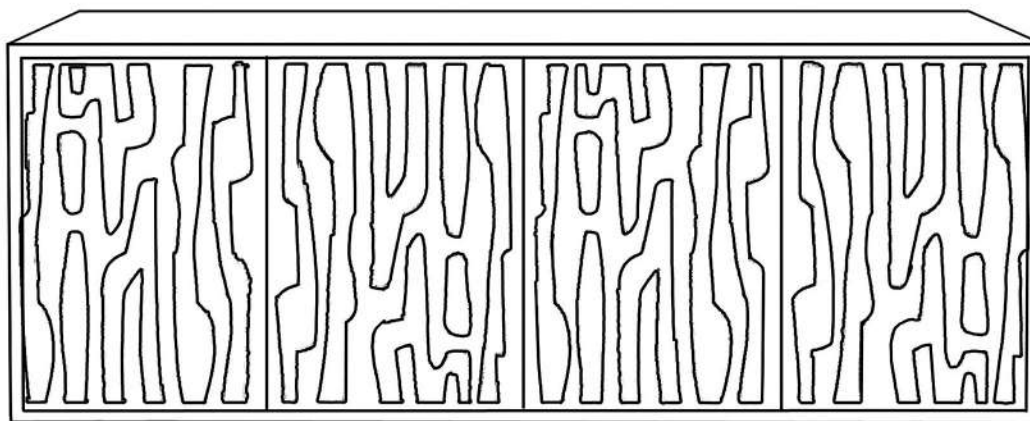

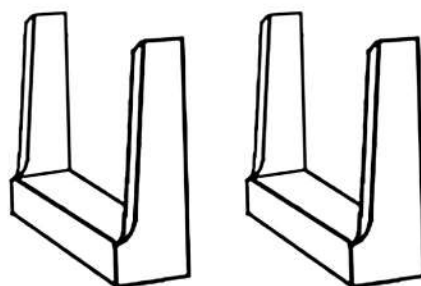

01pc

02

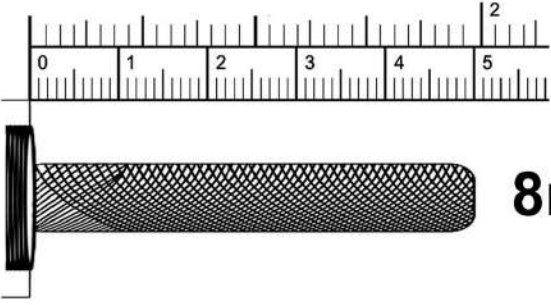

02pc

HERRAJES - QUINCALLERIE - HARDWARE

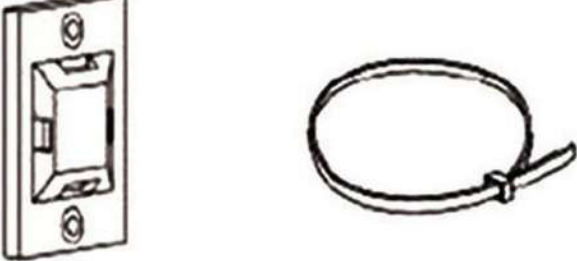
A	 <p>8mm</p>	06
B	 <p>M5</p>	01
C		02

Step 1:

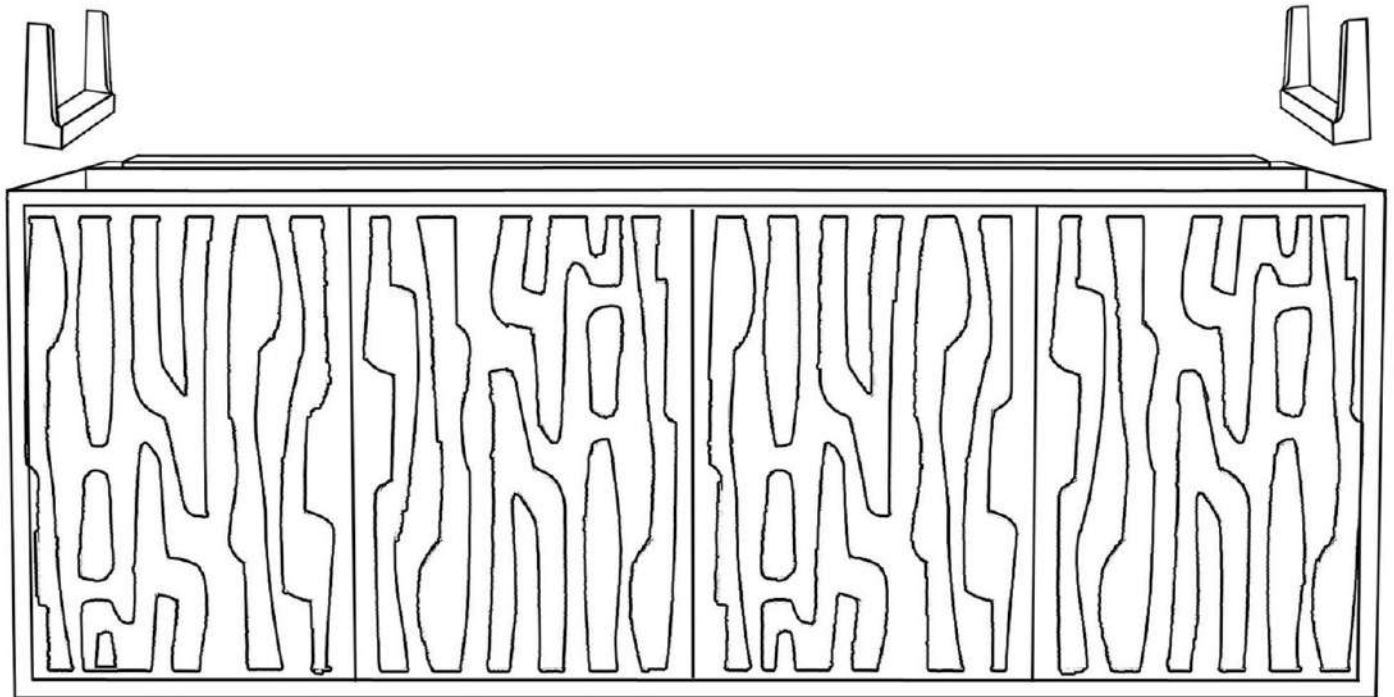

Step 2:

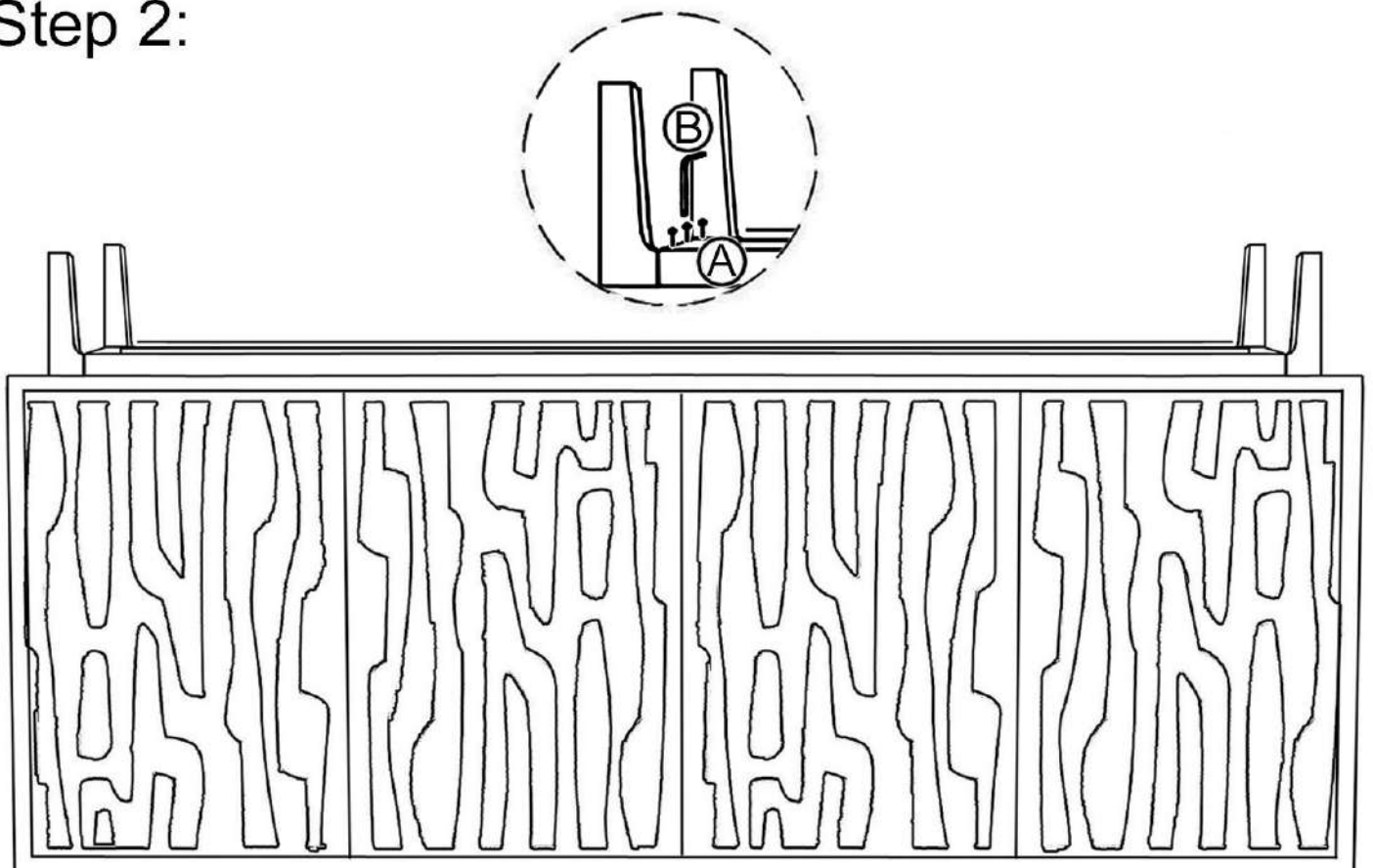

Step 3:

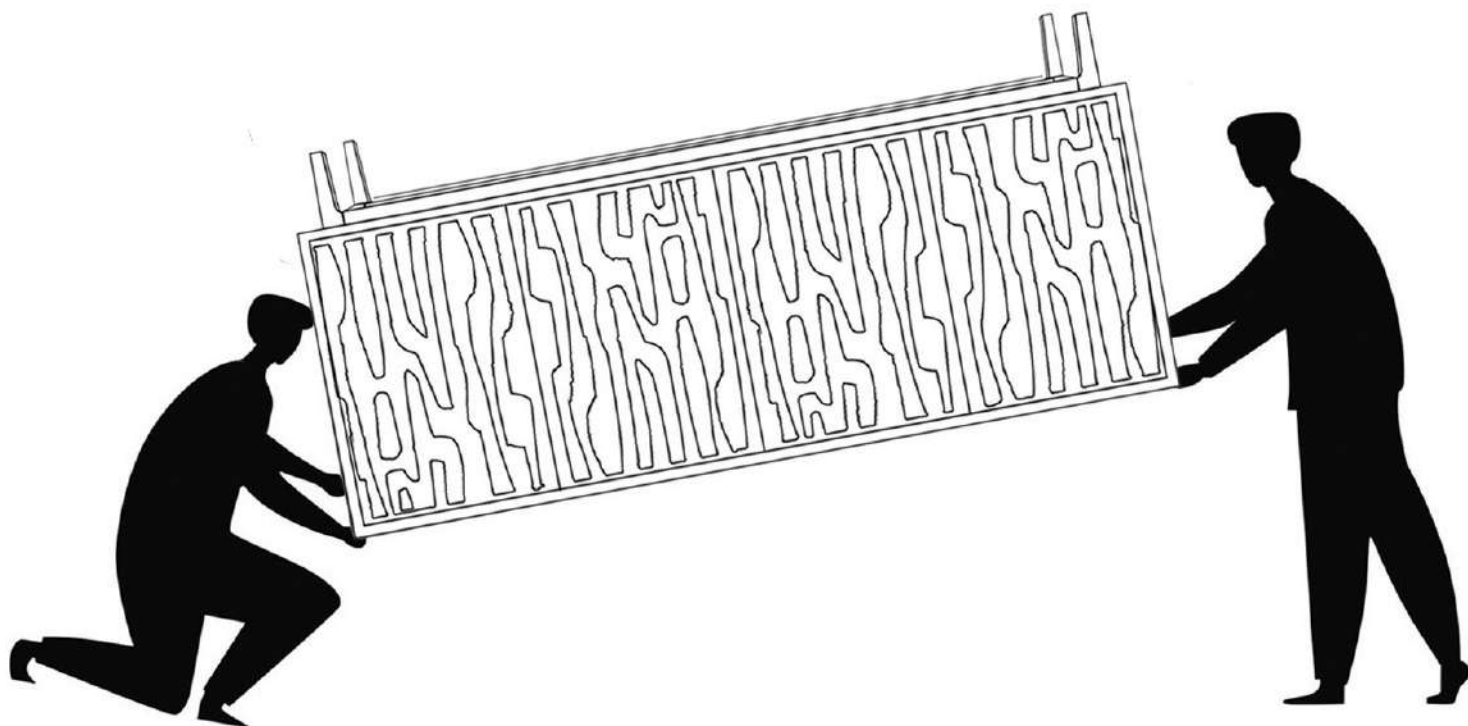

FRANÇAIS: BASCULER LE MEUBLE AVEC PRÉCAUTION. UTILISATION D'UNE COUVERTURE RECOMMANDÉE TPOUR NE PAS ABIMER LE MEUBLE.

ENGLISH: TURN THE FURNITURE CAREFULL. USE A COVER TO AVOID DAMAGE THE FURNITURE.

ESPAÑOL: GIRAR EL MUEBLE CON CUIDADO. UTILICE UN COBERTOR PARA EVITAR DAÑOS EN EL MUEBLE.

Step 4:

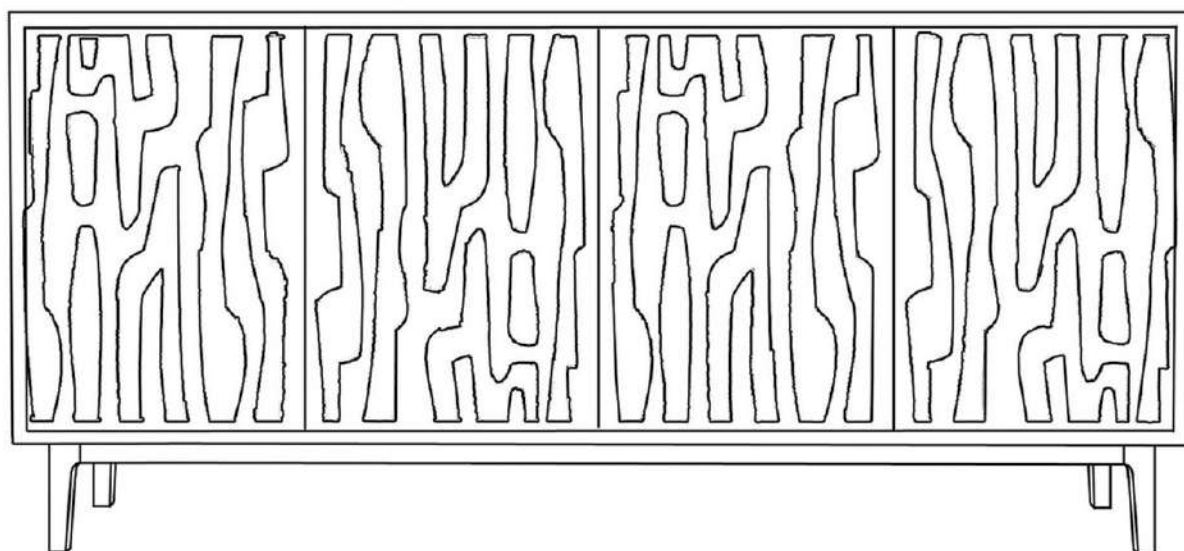

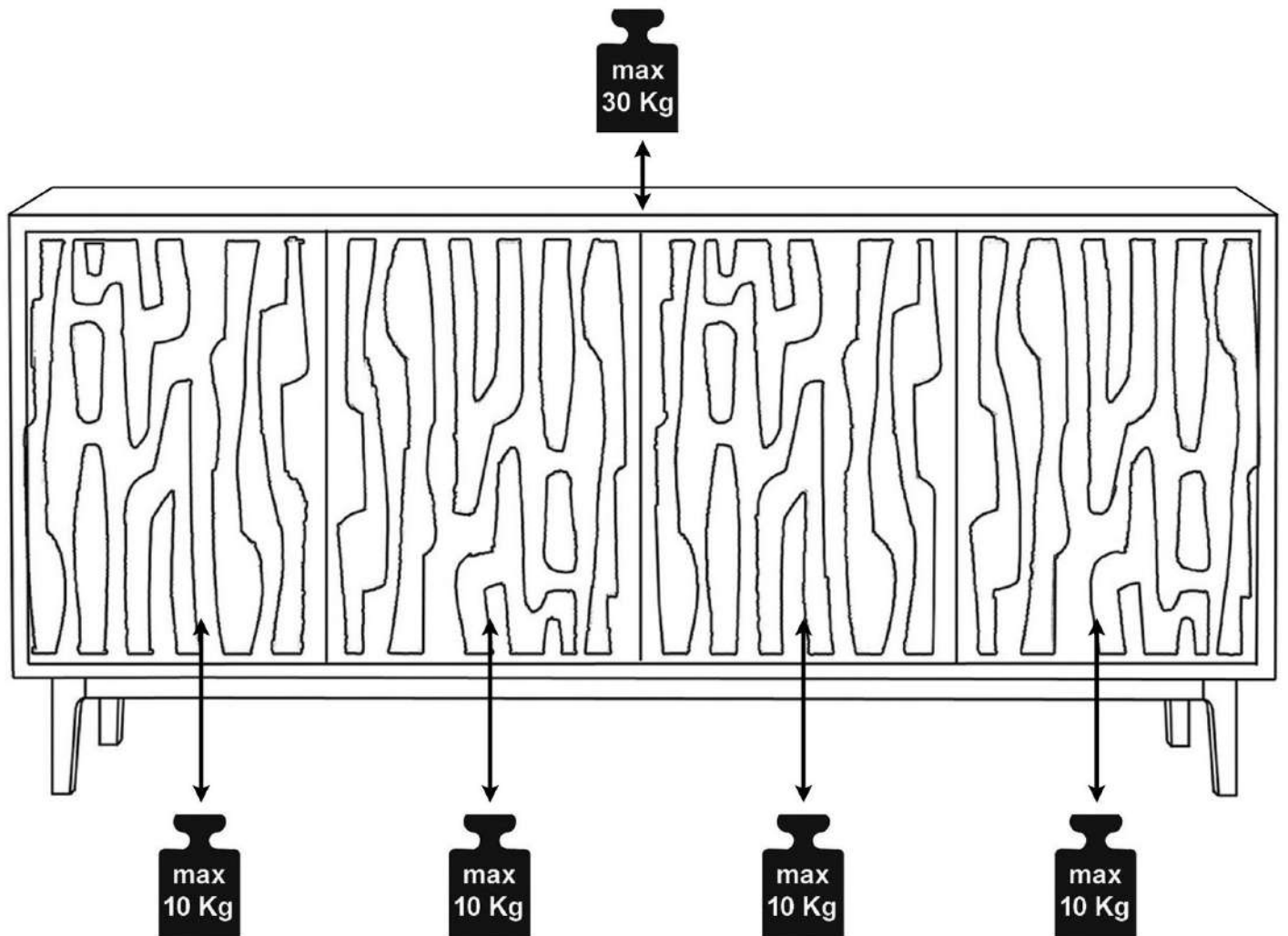
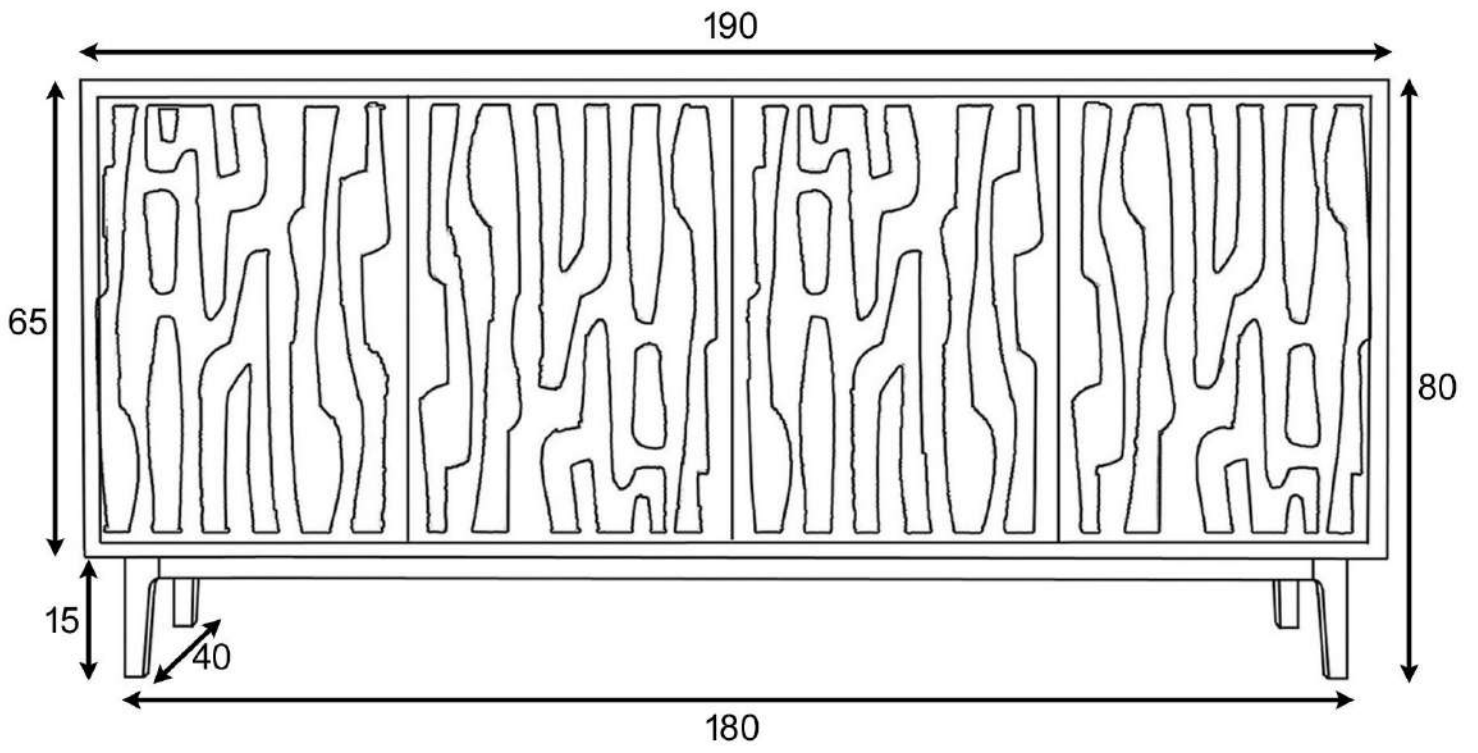

FRENCH: "Les meubles contenant des panneaux à base de bois (panneaux de particules, panneaux de fibres, contreplaqué...) peuvent émettre des substances polluantes dans l'air intérieur. Il est ainsi recommandé, après l'installation du meuble dans son logement, d'aérer fréquemment la pièce concernée pendant au moins quatre semaines afin de réduire son exposition aux polluants émis par le meuble."

SPANISH: Los muebles que contienen paneles a base de madera (Aglomerado, cartón, contrachapado ...) pueden emitir sustancias contaminantes en el aire. Por lo tanto, se recomienda airear frecuentemente los muebles al menos durante cuatro semanas después de su instalación para reducir su exposición a los contaminantes emitidos por los muebles.

ENGLISH: Furniture containing wood-based panels (Particle board, fibreboard, plywood ...) could emit pollutants on the air. Therefore, it is advisable to ventilate the furniture at least during four weeks after its assembly in order to reduce the exposure to the pollutants released by the furniture.

FRANCAIS - SUISSE

CONSEILS DE MONTAGE :

- 1 > BIEN ETUDIER LA NOTICE DE MONTAGE.
- 2 > REPEREZ LES PIECES CONSTITUANT VOTRE MEUBLE.
- 3 > REGROUPEZ ET CONTROLEZ LA QUINCAILLERIE.
- 4 > MUNISSEZ-VOUS DE L'OUTILLAGE NECESSAIRE.
- 5 > AMENAGEZ-VOUS UNE ZONE DE MONTAGE.
- 6 > PROCEDEZ AU MONTAGE.



**NE JAMAIS FORCER LES ASSEMBLAGES.
RESSERREZ LES VIS APRES QUELQUES TEMPS D'USAGE.
GARDER VOTRE NOTICE DE MONTAGE, SI UNE PIECE
VENAIT A MANQUER, ELLE SERAIT LE PLUS CLAIR
MOYEN DE COMMUNIQUER AVEC VOTRE MAGASIN.**

CONSEILS D'ENTRETIEN :

- 1 > DÉPOUSSIÉREZ SOIGNEUSEMENT.
- 2 > UTILISEZ UN CHIFFON SEC.



**- NE JAMAIS UTILISER
DE PRODUITS ABRASIFS:
POUDRE, LAINE D'ACIER, SOLVANTS.
- NE PAS MOILLER**

	PAPIER DECOR	SURFACES STRATIFIÉES	SURFACES LAQUÉES	BOIS VERNIS	TEXTILE CUIR
EAU SAVONNEUSE (SAVON NEUTRE)	○	○	○	○	○
EAU ADDITIO NÉE		○	○		
ENTRETIEN SPÉCIFIQUE FABRICANT					○

DEUTSCH - SCHWEIZ

MONTAGE ANLEITUNG:

- 1 > DIE MONTAGEANLEITUNG SORGFÄLTIG DURCHLESEN.
- 2 > DIE EINZELTEILE DES MÖBELSTÜCKS ERMITTELN.
- 3 > DIE BESCHLÄGE ZUSAMMENLEGEN UND PRÜFEN.
- 4 > DAS NOTWENDIGE WERKZEUG ZURECHTLEGEN.
- 5 > EINEN MONTAGEBEREICH FREIMACHEN.
- 6 > DAS MÖBELSTÜCK ZUSAMMENBAUEN.



**NIEMALS DIE VERBINDUNGEN ZU STARK ANZIEHEN.
DIE SCHRAUBEN NACH EINIGER ZEIT DES GEBRAUCHS
ERNEUT FESTZIEHEN. DIE MONTAGEANLEITUNG
GUT AUFBEWAHREN: SOLLTE EIN TEIL FEHLEN, IST SIE DAS
BESTE VERSTÄNDIGUNGSMITTEL MIT IHREM GESCHÄFT.**

PFLEGEHINWEISE :

- 1 > SORGFÄLTIG ENTSTAUBEN.
- 2 > VERWENDEN SIE EIN TROCKENES TUCH.



**- BENUTZEN SIE KEINE
SCHEUERMITTEL WIE PULVER,
STAHLWOLLE, LÖSUNGSMITTEL.
- KEIN WASSER VERWENDEN.**

	DEKORPAPIER	OBERFLÄCHE LAMINAT	OBERFLÄCHE LACK	LACKIERTEM HOLZ	TEXTIL LEDER
SEIFENLAUGE (NEUTRALSEIFE)	○	○	○	○	○
WASSER MIT HAUSHALTSRFINIGER		○	○		
PRODUZENT SPEZIFISCHER UNTERHALT					○

ITALIANO - SVIZZERA

CONSIGLI DI MONTAGGIO

- 1 > STUDIARE BENE LE ISTRUZIONI DI MONTAGGIO.
- 2 > PRENDERE CONOSCENZA DEI PEZZI CHE COSTITUISCONO IL MOBILE.
- 3 > RAGGRUPPARE E CONTROLLARE LA FERRAMENTA.
- 4 > MUNIRSI DEGLI UTENSILI NECESSARI.
- 5 > PREPARARE UNA ZONA DI MONTAGGIO.
- 6 > PROCEDERE AL MONTAGGIO.



**NON FORZARE MAI GLI ASSEMBLAGGI
RISTRINGERE LE VITI DOPO UN PERIODO D'USO
CONSERVARE QUESTE ISTRUZIONI DI MONTAGGIO,
SE UN PEZZO VENISSE A MANCARE SAREBBE IL MIGLIORE
MEZZO DI COMUNICAZIONE CON IL RIVENDITORE**

CONSIGLI PER LA MANUTENZIONE :

- 1 > SPOLVERATE ACCURATAMENTE.
- 2 > USARE UN PANNINO ASCIUTTO.



**- NON UTILIZZARE MAI PRODOTTI
ABRASIVI: POLVERE,
LANA DI ACCIAIO, SOLVENTI.
- NON BAGNARE.**

	CARTA	SUPERFICIE STRATIFICATE	SUPERFICIE LACCATE	LACCATE EGNO VERNICIATO	TESSILE CUOIO
ACQUA CON SAPONE (SAPONE NEUTRO)	○	○	○	○	○
ACQUA CON DETERSIVO SAN MARC		○	○		
MANUTENZIONE SPECIFICA PRODUTTORE					○

PORTUGUÊS

CONSELHOS DE MONTAGEM:

- 1 > ESTUDE BEM AS INSTRUÇÕES DE MONTAGEM.
- 2 > REUNA AS PEÇAS QUE CONSTITUEM O SEU MÓVEL.
- 3 > REAGRUPE AS FERRAGENS.
- 4 > EQUIPE-SE COM AS FERRAMENTAS NECESSÁRIAS.
- 5 > PREPARE UMA ÁREA PARA A MONTAGEM.
- 6 > INICIE A MONTAGEM.

**NUNCA FORÇAR OS ENCAIXES.
REAPERTAR OS PARAFUSOS APÓS UM TEMPO DE UTILIZAÇÃO.
GUARDAR AS INSTRUÇÕES DE MONTAGEM.
CASO FALTE ALGUMA PEÇA, O MAIS ACONSELHÁVEL
É CONTATAR O REVENDEDOR.**

CONSELHOS PARA A MANUTENÇÃO :

- 1 > ELIMINAR BEM O PÓ.
- 2 > USAR PANO SECO.

**- NUNCA UTILIZAR PRODUTOS
ABRASIVOS: SAPONÁCEOS,
LÃ DE AÇO, SOLVENTES.
- NÃO MOLHAR .**

	ACABAMENTO IMITAÇÃO	SUPERFÍCIES ESTRATIFICADAS	SUPERFÍCIES LACADAS	MADEIRA ENVERNIZADA	TEXTEIS PELES
ÁGUA COM SABÃO (SABÃO NEUTRO)	○	○	○	○	○
ÁGUA COM DETERGENTE		○	○		
INSTRUÇÕES ESPECÍFICAS DO FABRICANTE					○

ESPAÑOL

CONSEJOS PARA EL MONTAJE:

- 1 > ESTUDIE ATENTAMENTE EL MANUAL DE MONTAJE.
- 2 > LOCALICE LAS PIEZAS QUE CONSTITUYEN SU MUEBLE.
- 3 > REUNA Y CONTROLE LOS TORNILLOS.
- 4 > EQUIPE-SE DE LAS HERRAMIENTAS NECESARIAS.
- 5 > PREPARE UNA ZONA DE MONTAJE.
- 6 > REALICE EL MONTAJE.

**NO FUERCE NUNCA EN LAS UNIONES. APRIETE LOS
TORNILLOS DESPUES DE CIERTO TIEMPO DE UTILIZACION
CONSERVE SU MANUAL DE MONTAJE,
SI FALTARA UNA PIEZA, SERIA LA MANERA
MAS FACIL DE COMUNICAR CON LA TIENDA.**

CONSEJOS PARA EL MANTENIMIENTO:

- 1 > DESPOLVEAR CULDADOSAMENTE.
- 2 > UTILICE UN PAÑO SECO.

**- NO USE NUNCA PRODUCTOS
ABRASIVOS TALES COMO:
POLVO DE LIMPIAR,
LANA DE ACERO, SOLVENTES.
- NO MOJAR.**

	PAPEL DE DECORACION	SUPERFICIE ESTRATIFICADAS	SUPERFICIE MAQUEADAS	MADERA BARNIZADA	TEXTIL CUERO
AGUA Y JABON (JABON NEUTRO)	○	○	○	○	○
AGUA COM DETERGENTE		○	○		
MANTENIMIENTO ESPECIFICO DEL FABRICANTE					○

HRVATSKA

UPUTE ZA MONTAŽU:

- 1 > PAŽLJIVO PROČITAJTE UPUTE ZA MONTAŽU.
- 2 > PRIPREMITE SVE DIJELOVE NAMJEŠTAJA.
- 3 > PRIKUPITE I PROVJERITE OKOVE ZA MONTAŽU.
- 4 > PRIPREMITE POTREBAN ALAT.
- 5 > PRIPREMITE PROSTOR ZA MONTAŽU.
- 6 > POČNITE MONTIRATI.

**NEMOJTE UPOTREBLJAVATI SILU PRILIKOM SKLAPANJA
NAKON NEKOG VREMENA PONOVRNO PRITEGNITE VIJKE
ČUVAJTE UPUTE ZA MONTAŽU
U SLUČAJU NEDOSTATKA NEKOG DIJELA NAJBOLJE ĆE BITI DA
DA KONTAKIRATE PRODAJNO MJESTO.**

UPUTE ZA ODRŽAVANJE :

- 1 > PAŽLJIVO OBRISATI PRAŠINU.
- 2 > KORISTITE SUHU KRPU.

**- ZABRANJENA JE UPOTREBA
KEMIKALIJA ILI BILO KAKVIH
POMOĆNIH SREDSTAVA ZA RIBANJE
JAKIH SREDSTAV ZA ČIŠĆENJE ILI
ČELIČNE VUNE
-NE MOKRA.**

	PAPIR	LAMINAT	LAK	DRVO	TEKSTIL/ KOŽA
OTPINA SAPUNA	○	○	○	○	○
OTPINA DETERDŽENTA		○	○		
NAMJENSKA SREDSTVA					○

TÜRÇE

MONTAJ TALIMATLARI:

- 1 > MONTAJ TANITIM YAZISINI DIKKATLICE OKUYUNUZ .
- 2 > MOBİLİYANIZI OLUŞTURAN PARÇALARI İŞARETLEYİNİZ.
- 3 > HIRDAVATLA İLGİLİ PARÇALARI BİR ARAYA TOPLAYIP; KONTROL EDİNİZ.
- 4 > GEREKEN ARAÇ VE GERECE TEDARİK EDİNİZ.
- 5 > (KENDİNİZE) BİR MONTAJ ALANI EDİNİNİZ.
- 6 > MONTE ETMEYE BAŞLAYINIZ.

MONTAJLARI ZORLAMAYINIZ.
BİRKAÇ KULLANIMDAN SONRA VIDALARI SIKIŞTIRINIZ.
BİR PARÇANIN KAYBOLMASI DURUMUNDA MAGAZANIZLADAHA
KOLAY İLETİŞİME GEÇEBİLMENİZ İÇİN MONTAJJ KULLANIM
TALIMATINIZI SAKLAYINIZ.

BAKIM TALIMATLARI:

- 1 > TOZUNU DIKKATLICE ALINIZ.
- 2 > YUMUŞAK BİR BEZİ TEMİZ SU VE AZ MİKTARDA SABUNLA(DETERJAN) NEMLENDİRİNİZ.

ASLA AŞINDIRICI ÜRÜNLER
KULLANMAYINIZ : ÇELİK YÜNÜ,
SOLVENT...
BOL SUYLA YIKAMAYINIZ.

	SÛS KAGIDI	KATMAN YÜZEY	LAKE YÜZEY	CILALI TAHTA	TEKSTİL DERİ
SABUNLU SU (NOTR SABUN)	○	○	○	○	○
DETERJAN KATILMIŞ SU		○	○		
ÜRETİCİYE ÖZGÜ BAKIM					○

ENGLISH

ASSEMBLY ADVICE :

- 1 > CAREFULLY READ THE ASSEMBLY INSTRUCTION.
- 2 > IDENTIFY THE COMPONENTS OF THE FURNITURE.
- 3 > GROUP AND CHECK THE HARDWARE.
- 4 > USE THE REQUIRED TOOLS.
- 5 > CREATE AN ASSEMBLY ZONE.
- 6 > MAKE THE ASSEMBLY.

NEVER FORCE THE CONNECTIONS.
RE-TIGHTEN THE SCREWS AFTER FEW DAYS.
PLEASE RETAIN THE AI LEAFLET FOR FUTURE REFERENCE,
THE AI CONTAINS INFORMATION WHEN CLAIMING
FOR MISSING PARTS.

CLEANING ADVICE:

- 1 > CAREFULLY REMOVE THE DUST.
- 2 > USE A SOFT, CLEAN DAMP CLOTH WITH SOAPY WATER.

NEVER USE ABRASIVE PRODUCTS
OR SOLVENTS.
DO NOT APPLY EXCESSIVE PRESSURE
WHEN USING THE DAMP CLOTH.

	PAPER DECOR	LAMINATED SURFACES	LACQUERED SURFACE	VARNISHED WOOD	LEATHER TEXTILE
SOAPY WATER (NEUTRAL SOAP)	○	○	○	○	○
WATER WITH DETERGENT		○	○		
SPECIFIC SUPPLIER CLEANING					○



LE TRI
+ FACILE



FR

Donnez ou recyclez
vos meubles.



Association



Magasin



Déchèterie

<https://quefairedemesdechets.fr>

PIU No. : 1852
 ITEM : 18546
 MODEL: APARADOR KANTU 4P MADERA MANGO
 SIDEBOARD KANTU 4D MANGO WOOD
 BUFFET KANTU 4P MANGUIER

COLOR: MANGO WOOD / BLACK
 NET WT.: 62 Kgs
 GROSS WT.: 68 Kgs
 CARTON SIZE: 198x48x77 Cms
 QTY.: 1 Pz.
 Carton: 1/1

6433176318944

PIU No. : 1852
 ITEM : 18546
 MODEL: APARADOR KANTU 4P MADERA MANGO
 SIDEBOARD KANTU 4D MANGO WOOD
 BUFFET KANTU 4P MANGUIER

COLOR: MANGO WOOD / BLACK
 NET WT.: 62 Kgs
 GROSS WT.: 68 Kgs
 CARTON SIZE: 198x48x77 Cms
 QTY.: 1 Pz.
 Carton: 1/1





6433176318944

ME
 marckeric

MARQUERIE S.L.
 C/ FRANC VIEOLA 5/N,
 PC 46400 SOLLANA / VALENCIA / SPAIN

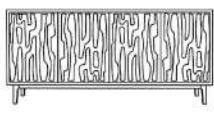
↑ FURNITURE FRAGILE ↑
 UP HANDLE WITH CARE UP

ITEM : 18546
 MODEL: APARADOR KANTU 4P MADERA MANGO
 SIDEBOARD KANTU 4D MANGO WOOD
 BUFFET KANTU 4P MANGUIER

COLOR: MANGO WOOD / BLACK
 NET WT.: 62 Kgs
 GROSS WT.: 68 Kgs
 CARTON SIZE: 198x48x77 Cms
 QTY.: 1 Pz.
 Carton: 1/1



6433176318944

ME
 marckeric

MARQUERIE S.L.
 C/ FRANC VIEOLA 5/N,
 PC 46400 SOLLANA / VALENCIA / SPAIN

↑ FURNITURE FRAGILE ↑
 UP HANDLE WITH CARE UP

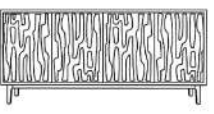
ITEM : 18546
 MODEL: APARADOR KANTU 4P MADERA MANGO
 SIDEBOARD KANTU 4D MANGO WOOD
 BUFFET KANTU 4P MANGUIER

COLOR: MANGO WOOD / BLACK
 NET WT.: 62 Kgs
 GROSS WT.: 68 Kgs
 CARTON SIZE: 198x48x77 Cms
 QTY.: 1 Pz.
 Carton: 1/1



6433176318944

PIU No. : 1852
 ITEM : 18546
 MODEL: APARADOR KANTU 4P MADERA MANGO
 SIDEBOARD KANTU 4D MANGO WOOD
 BUFFET KANTU 4P MANGUIER

COLOR: MANGO WOOD / BLACK
 NET WT.: 62 Kgs
 GROSS WT.: 68 Kgs
 CARTON SIZE: 198x48x77 Cms
 QTY.: 1 Pz.
 Carton: 1/1



6433176318944

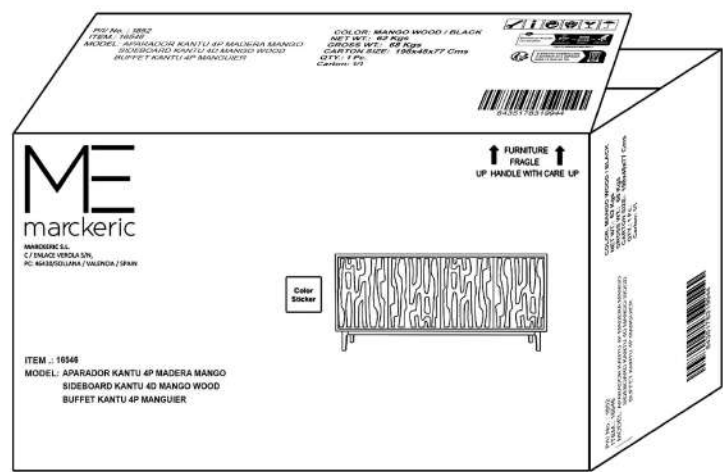

PIU No. : 1852
 ITEM : 18546
 MODEL: APARADOR KANTU 4P MADERA MANGO
 SIDEBOARD KANTU 4D MANGO WOOD
 BUFFET KANTU 4P MANGUIER

COLOR: MANGO WOOD / BLACK
 NET WT.: 62 Kgs
 GROSS WT.: 68 Kgs
 CARTON SIZE: 198x48x77 Cms
 QTY.: 1 Pz.
 Carton: 1/1

ME
 marckeric

MARQUERIE S.L.
 C/ FRANC VIEOLA 5/N,
 PC 46400 SOLLANA / VALENCIA / SPAIN

↑ FURNITURE FRAGILE ↑
 UP HANDLE WITH CARE UP

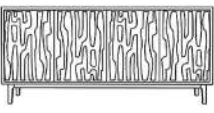
ITEM : 18546
 MODEL: APARADOR KANTU 4P MADERA MANGO
 SIDEBOARD KANTU 4D MANGO WOOD
 BUFFET KANTU 4P MANGUIER

COLOR: MANGO WOOD / BLACK
 NET WT.: 62 Kgs
 GROSS WT.: 68 Kgs
 CARTON SIZE: 198x48x77 Cms
 QTY.: 1 Pz.
 Carton: 1/1



6433176318944

ME

marckeric

MARCKERIC S.L.

C / ENLACE VEROLA S/N,

PC: 46430/SOLLANA / VALENCIA / SPAIN

Color
Sticker

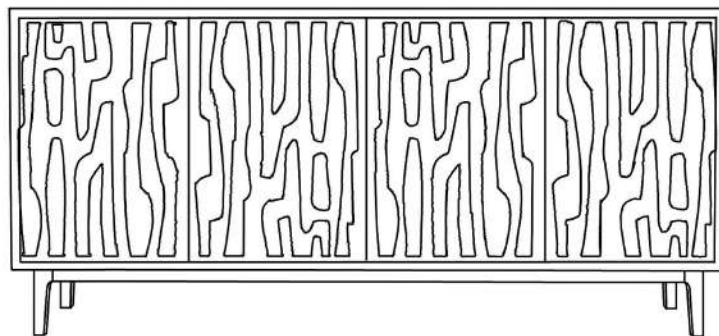

ITEM .: 16546

MODEL: APARADOR KANTU 4P MADERA MANGO

SIDEBOARD KANTU 4D MANGO WOOD

BUFFET KANTU 4P MANGUIER



8435178319944

P// No. : 1852

ITEM.: 16546

MODEL: APARADOR KANTU 4P MADERA MANGO

SIDEBORD KANTU 4D MANGO WOOD

BUFFET KANTU 4P MANGUIER

N.W: 62.00 Kgs G.W: 68.00 Kgs

QTY: 1 PCS/CTN

CARTON SIZE: 198*48*77 (Cms)

↑ FURNITURE ↑
FRAGLE
UP HANDLE WITH CARE UP

Fr

Donnez ou recyclez
vos meubles



Association



Magasin



Déchèterie



ÉLÉMENTS D'EMBALLAGE
À SÉPARER ET À DÉPOSER
DANS LE BAC DE TRI



<https://quefairedemsdechets.fr>

M E

marckeric

MARCKERIC S.L.

C / ENLACE VEROLA S/N,

PC: 46430/SOLLANA / VALENCIA / SPAIN