

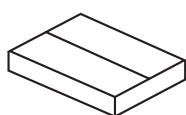

5 min



x1



x1



Ax1

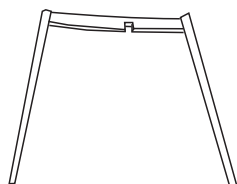

Bx1

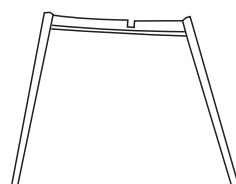

Cx1

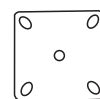

Dx1



Ex5(M6x30)



Fx4(M6x38)



Gx4



Hx1



1

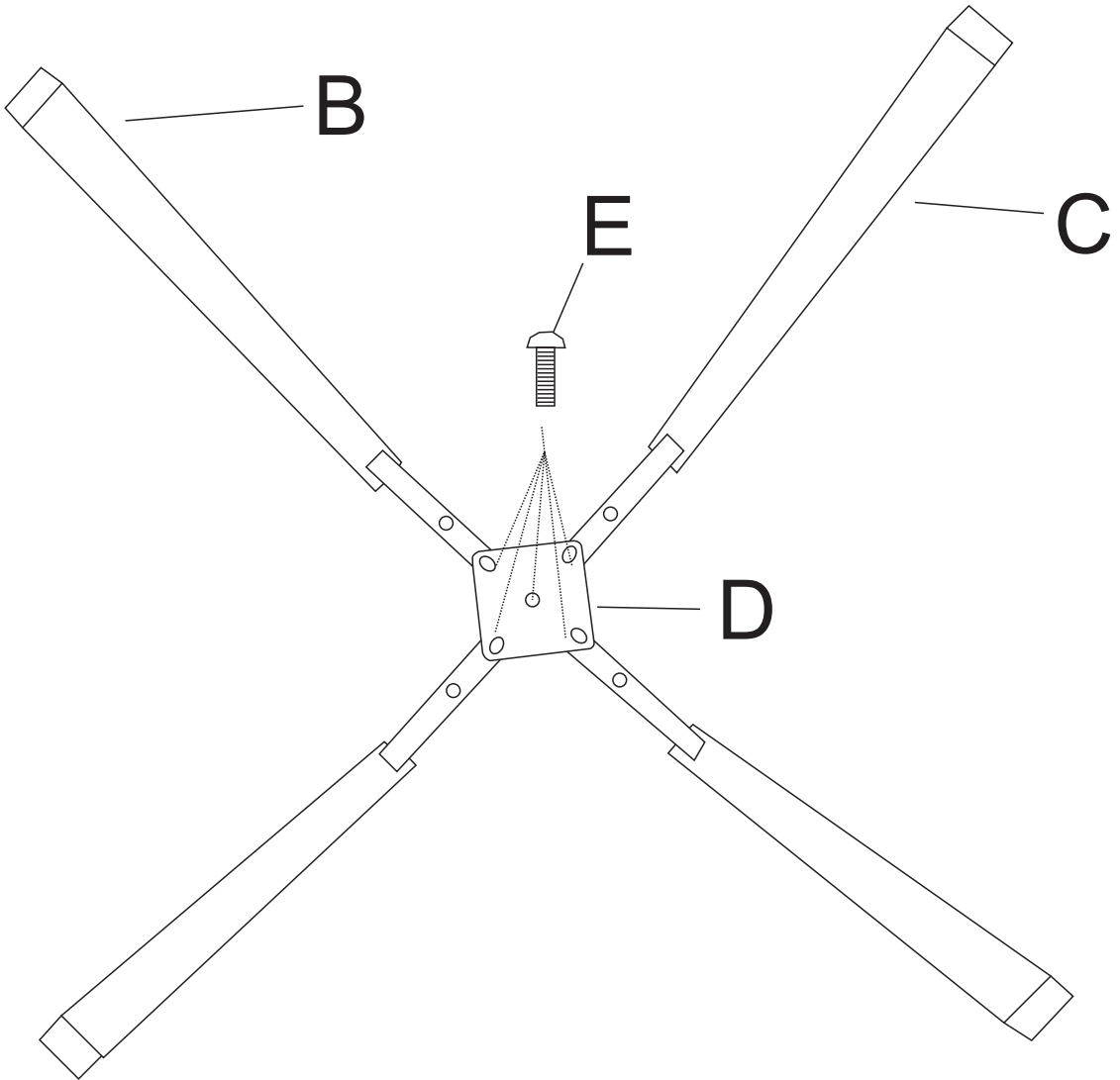



2

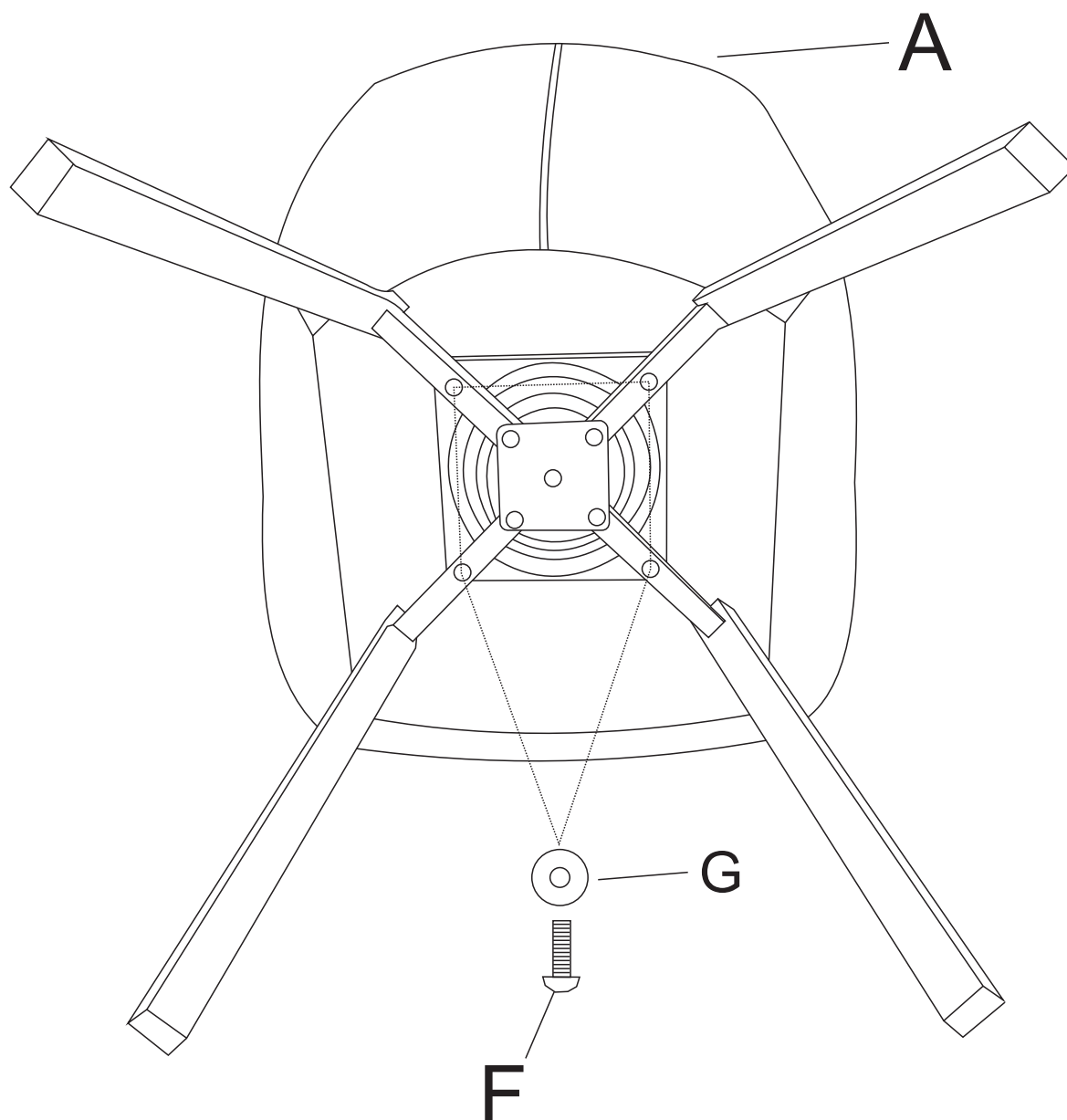



---

3

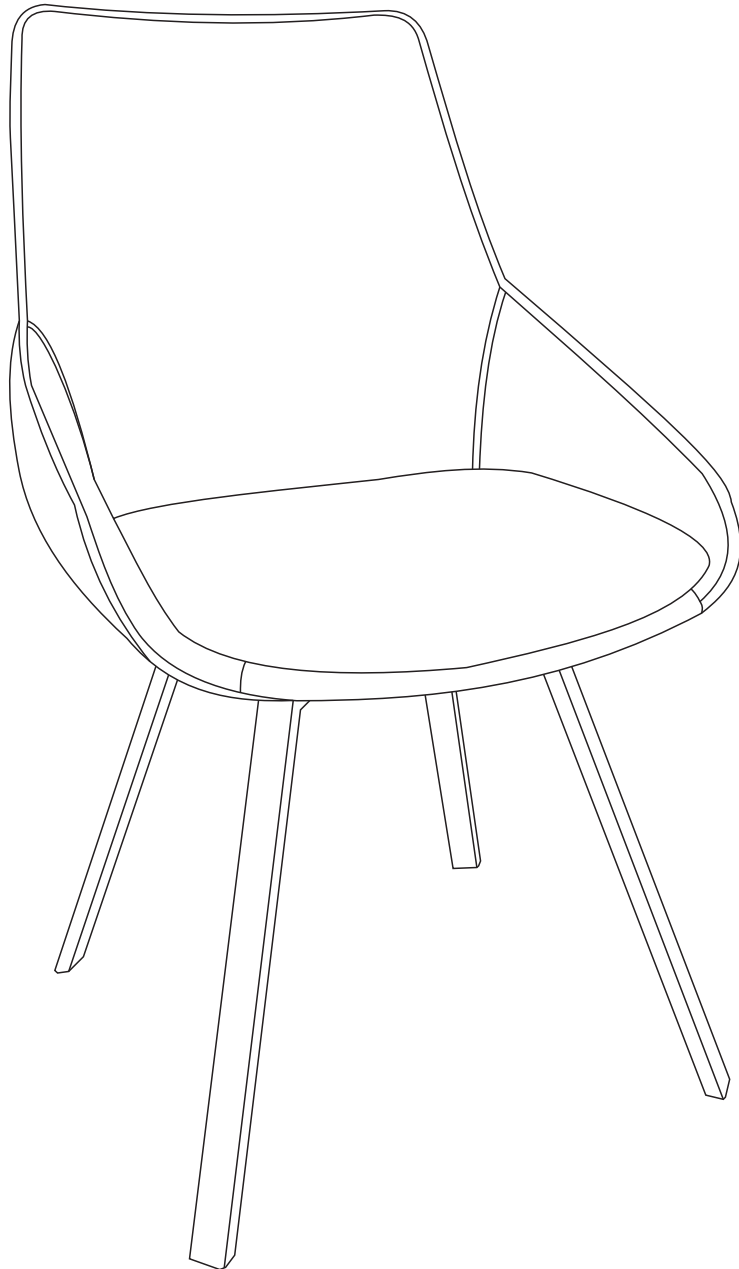



**JULIÀ GRUP Furniture Solutions S.L.**

B-17616277

Pol. Ind. Bosc d'en Cuca

C / Tallers, 14

17410 Sils SPAIN

[contact@kavehome.com](mailto:contact@kavehome.com)