

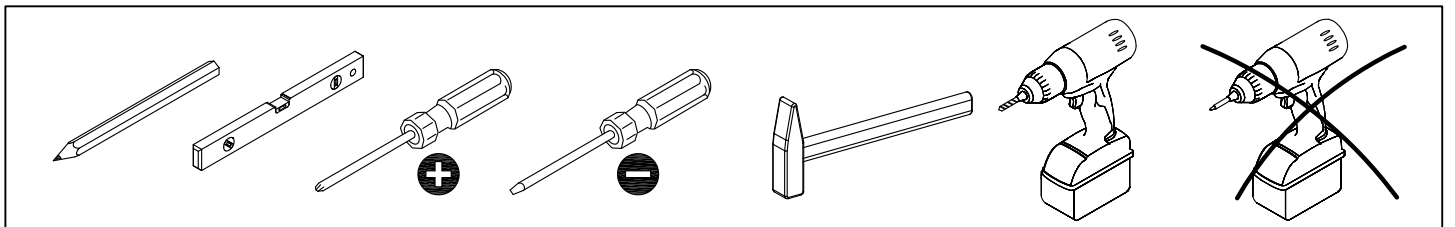

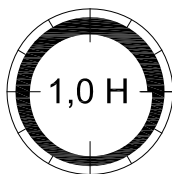

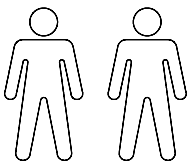

# LANGLEY

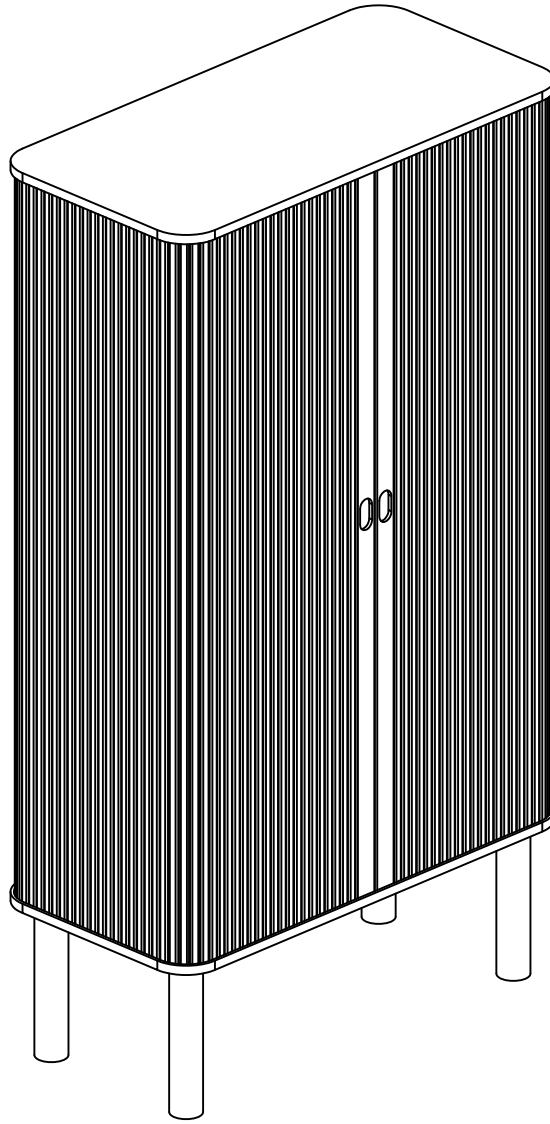
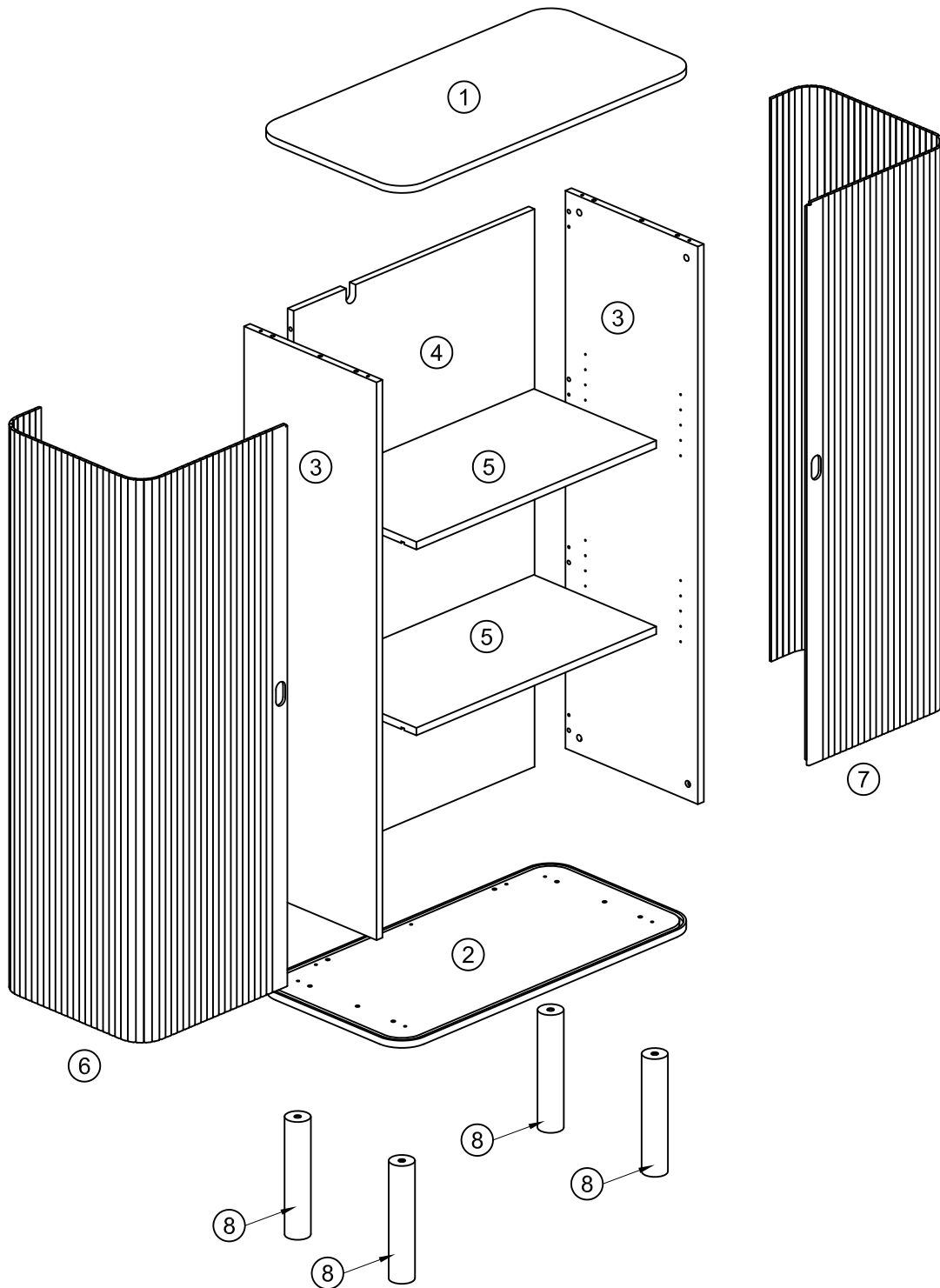

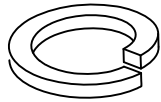

			✓
①	1	800x400x15	
②	1	800x400x15	
③	2	1170x356x16	
④	1	1170x648x16	

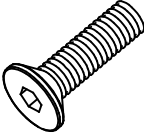
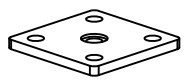
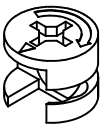
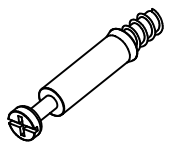
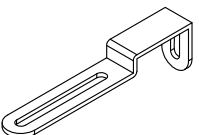
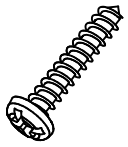
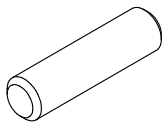
			✓
⑤	2	645x329x16	
⑥	1	1180x805x15	
⑦	1	1180x805x15	
⑧	4	247xØ50	

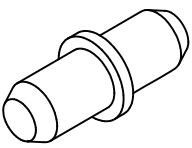



<p>A x 16</p>  <p>M6x15 mm</p>	<p>B x 16</p>  <p>Ø6 mm</p>	<p>D x 1</p>  <p>4 mm</p>	<p>E x 4</p>  <p>M6x20 mm</p>	<p>F x 4</p>  <p>75x75x3 mm</p>
<p>G x 22</p>  <p>Ø15x12 mm</p>	<p>H x 22</p>  <p>Ø6x43 mm</p>	<p>J x 1</p>  <p>96x15x25 mm</p>	<p>K x 2</p>  <p>Ø3.5x16 mm</p>	<p>L x 24</p>  <p>Ø8x30 mm</p>
<p>M x 8</p>  <p>Ø20 mm</p>	<p>N x 8</p>  <p>Ø5x16 mm</p>			

# 1

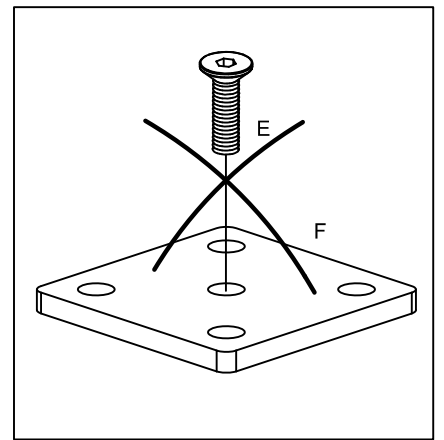
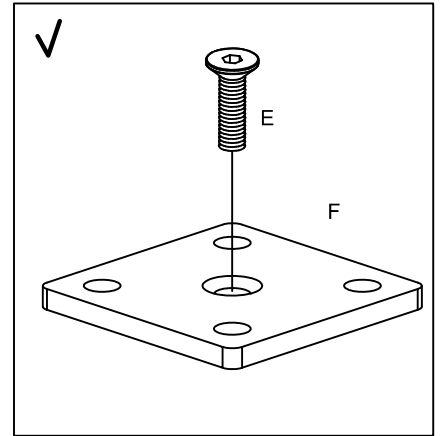
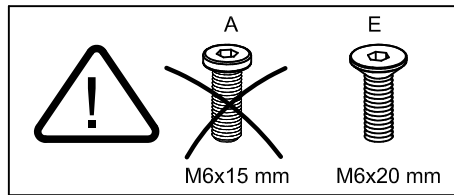
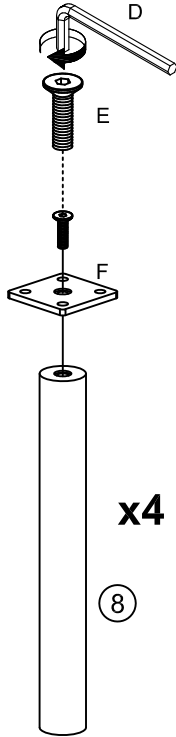
D x 1  4 mm	E x 4  M6x20 mm	F x 4  75x75x3 mm
--	--	--

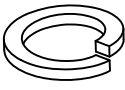

# 2

A x 16  M6x15 mm	B x 16  Ø6 mm	D x 1  4 mm
---	--	--

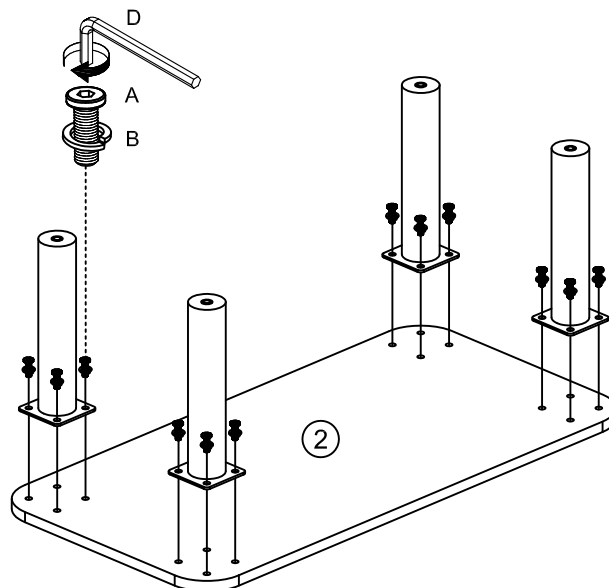

# 3

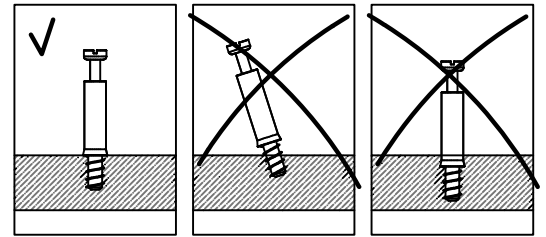
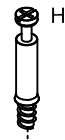
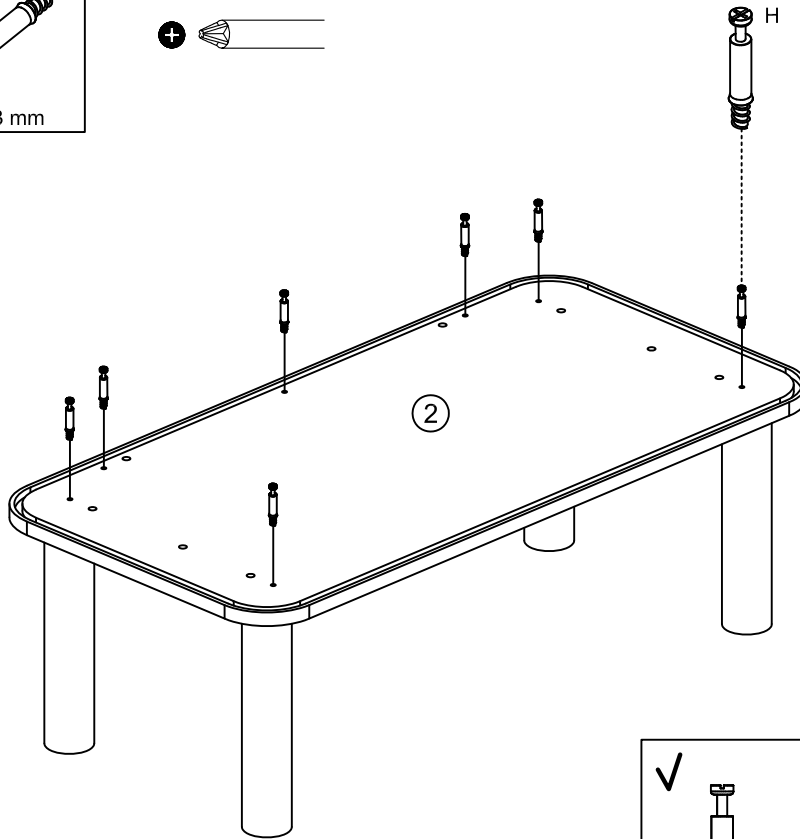
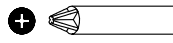
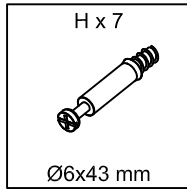

# 4

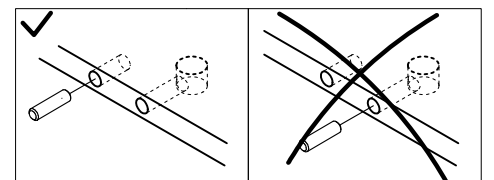
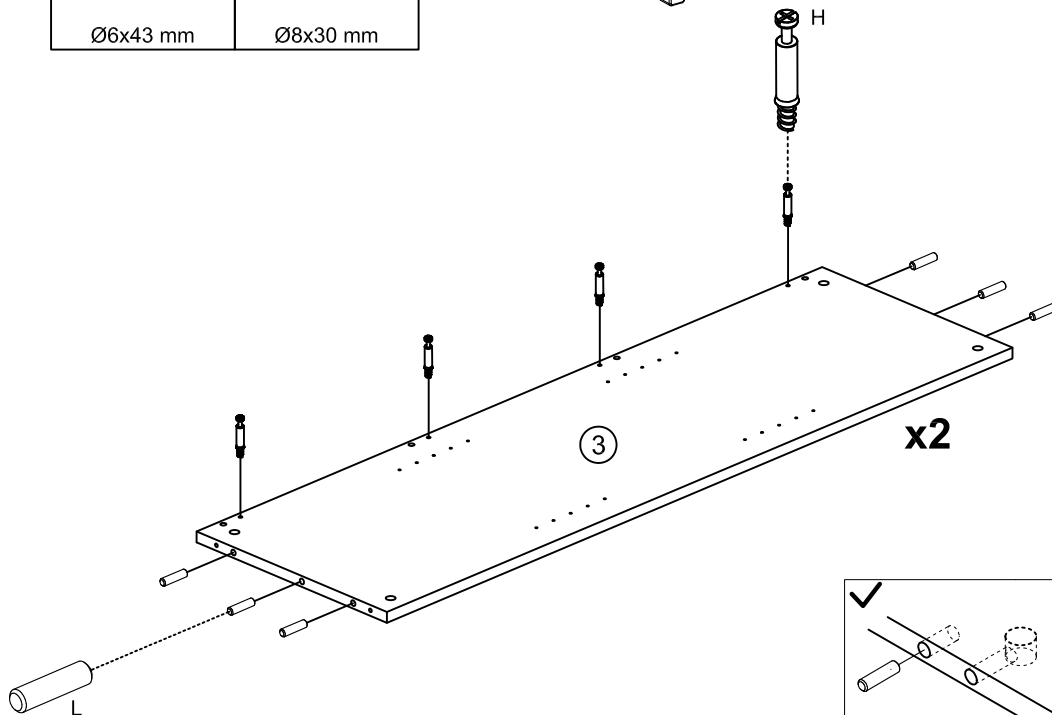
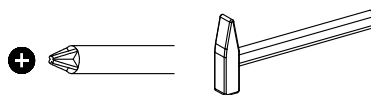
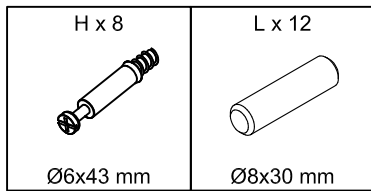

# 5

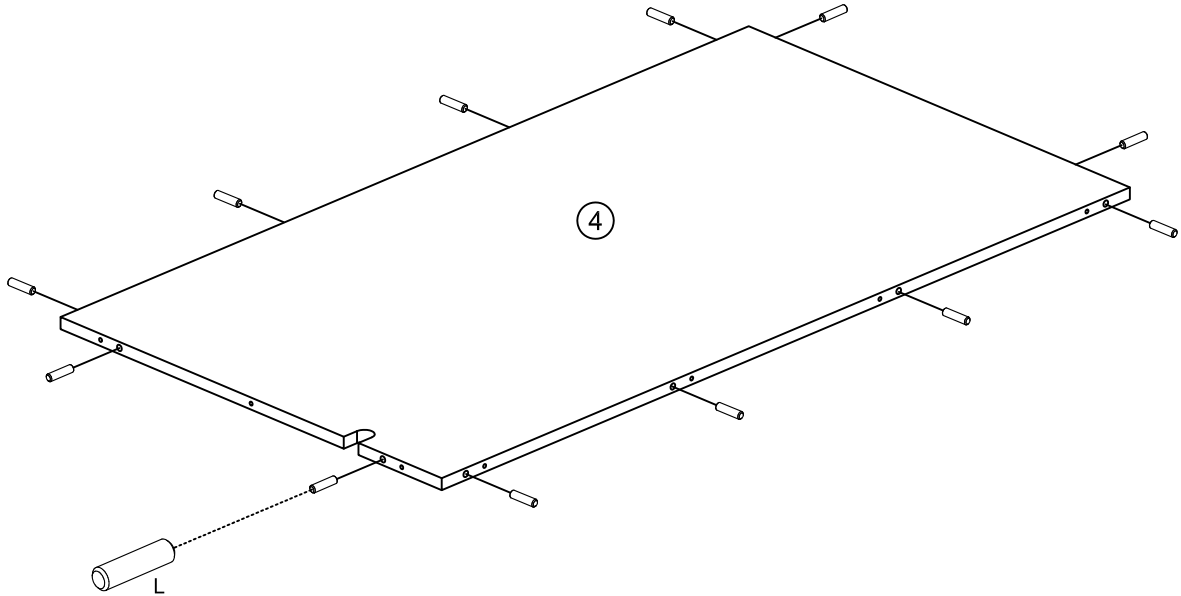
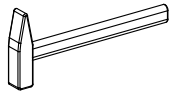
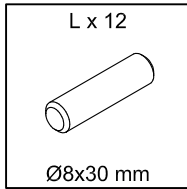

# 6

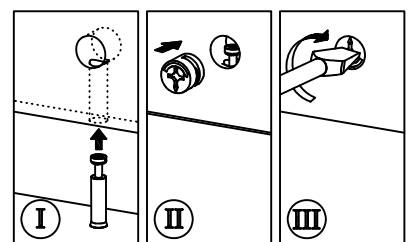
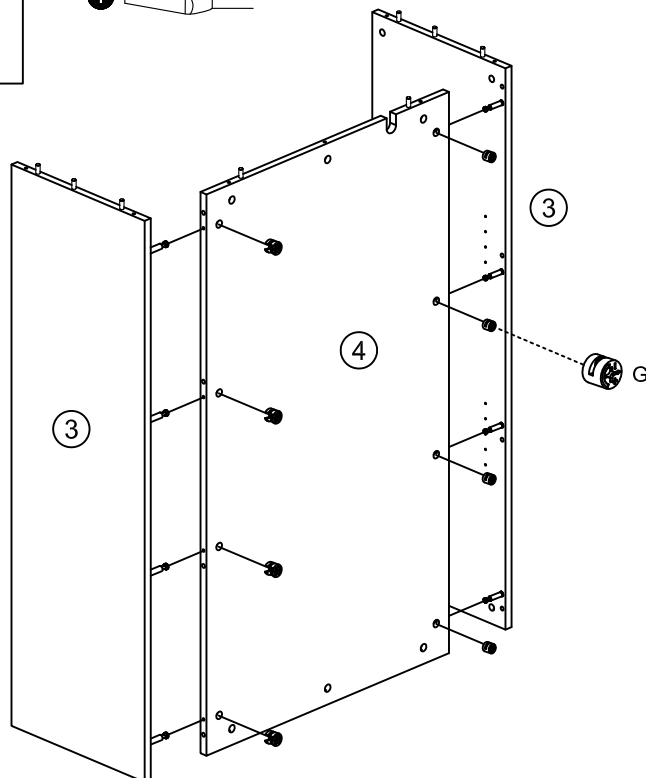
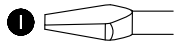
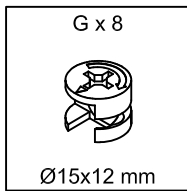

# 7

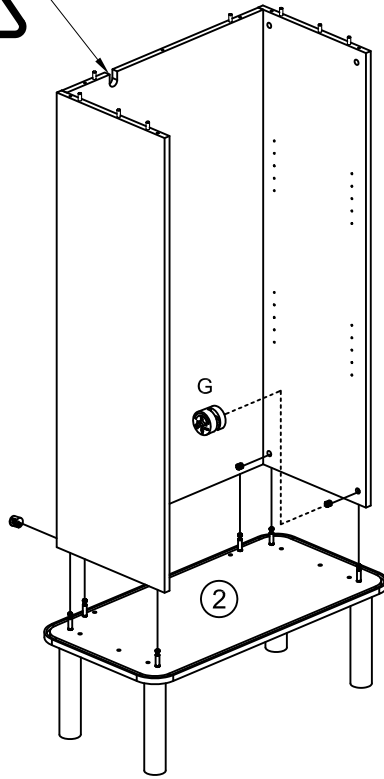
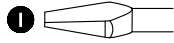
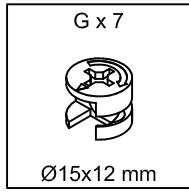

# 8

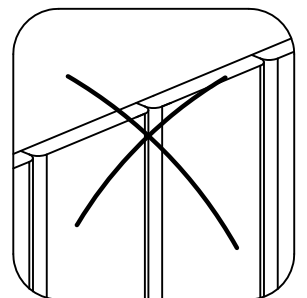
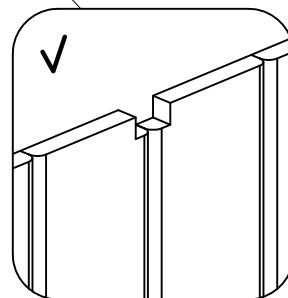
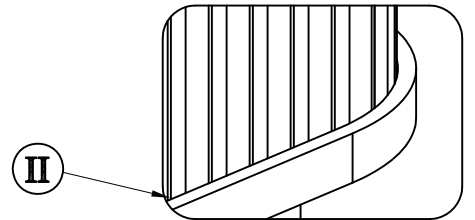
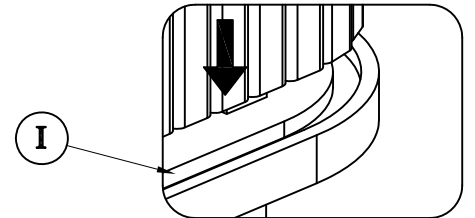
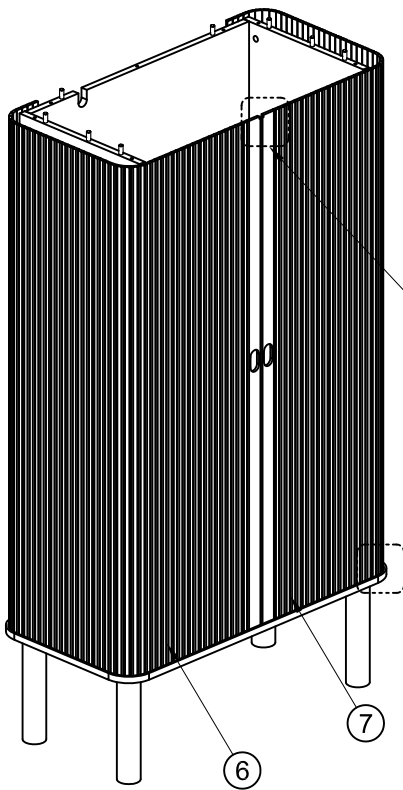

# 9

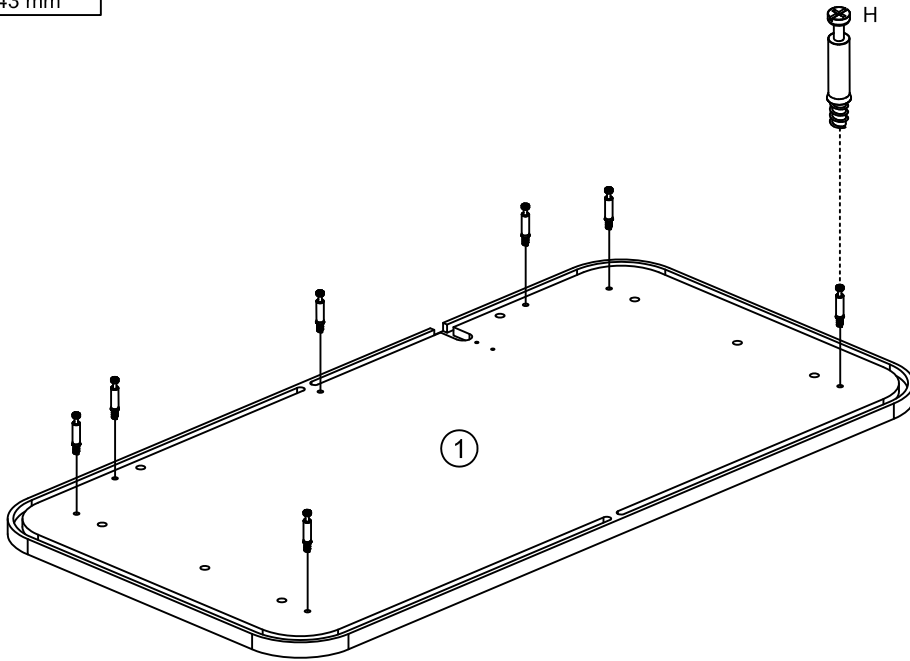
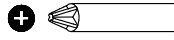
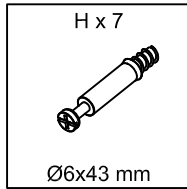

# 10

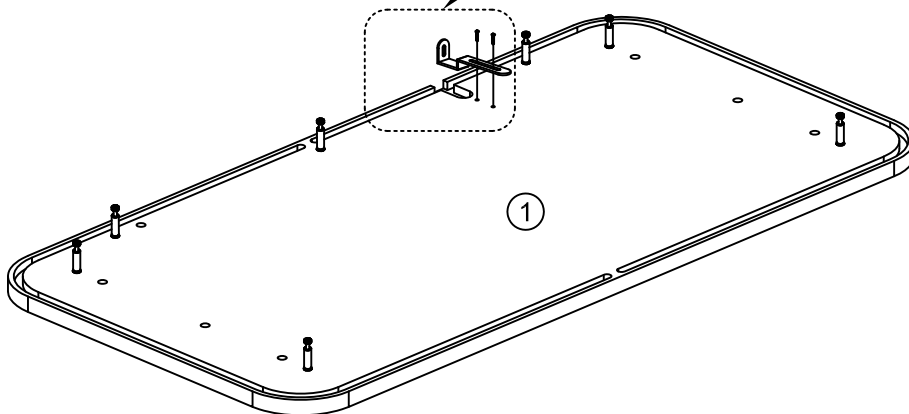
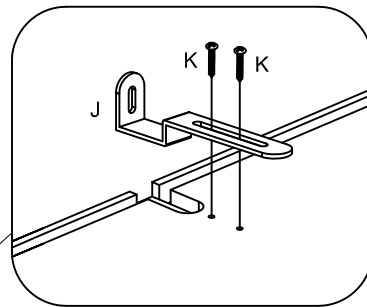
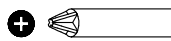
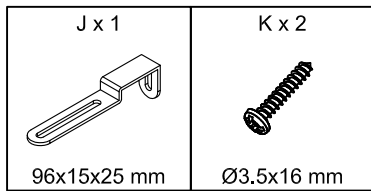



# 11

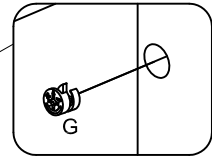
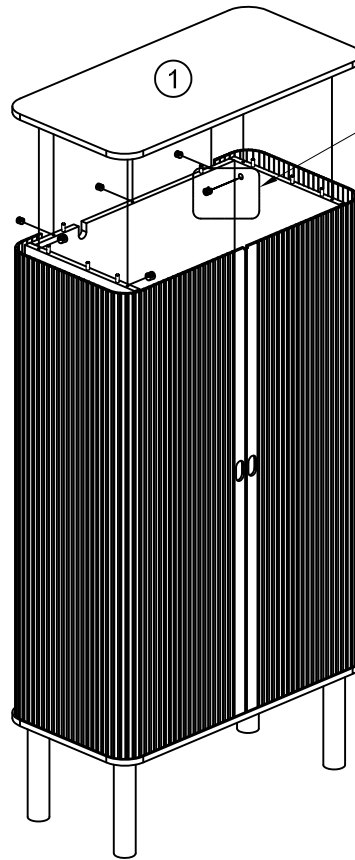
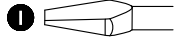
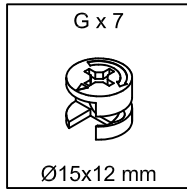

# 12

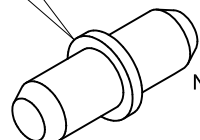
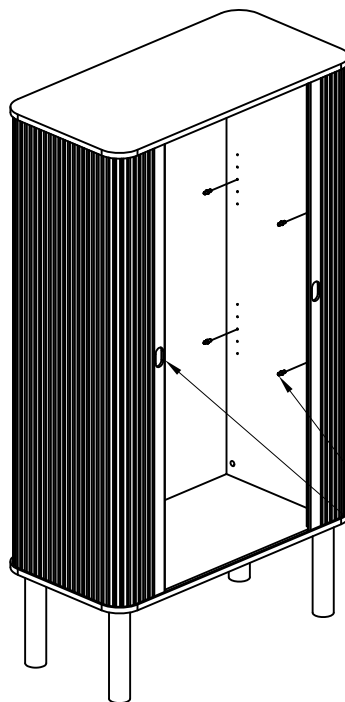
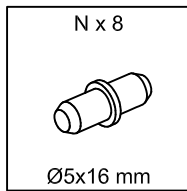

# 13

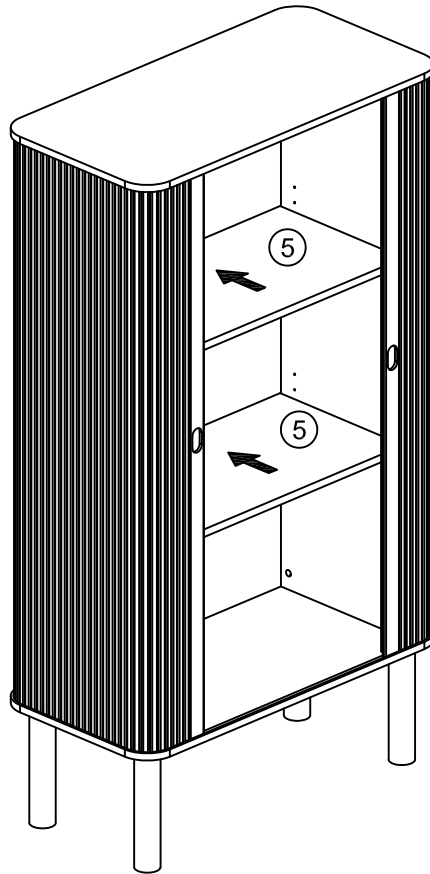

# 14

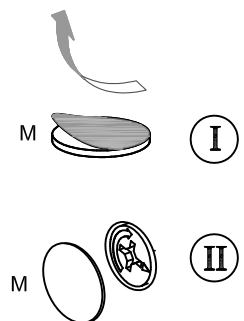
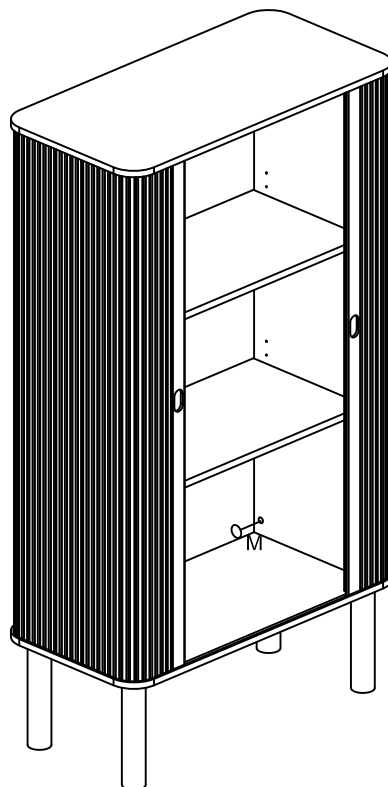
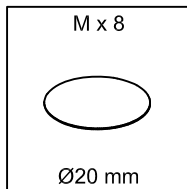

15

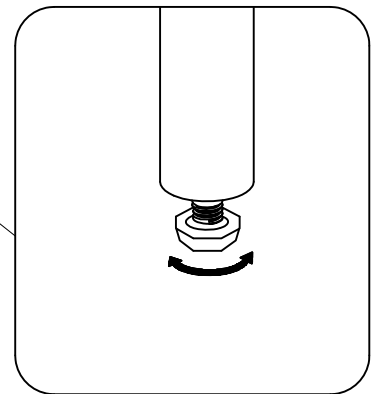
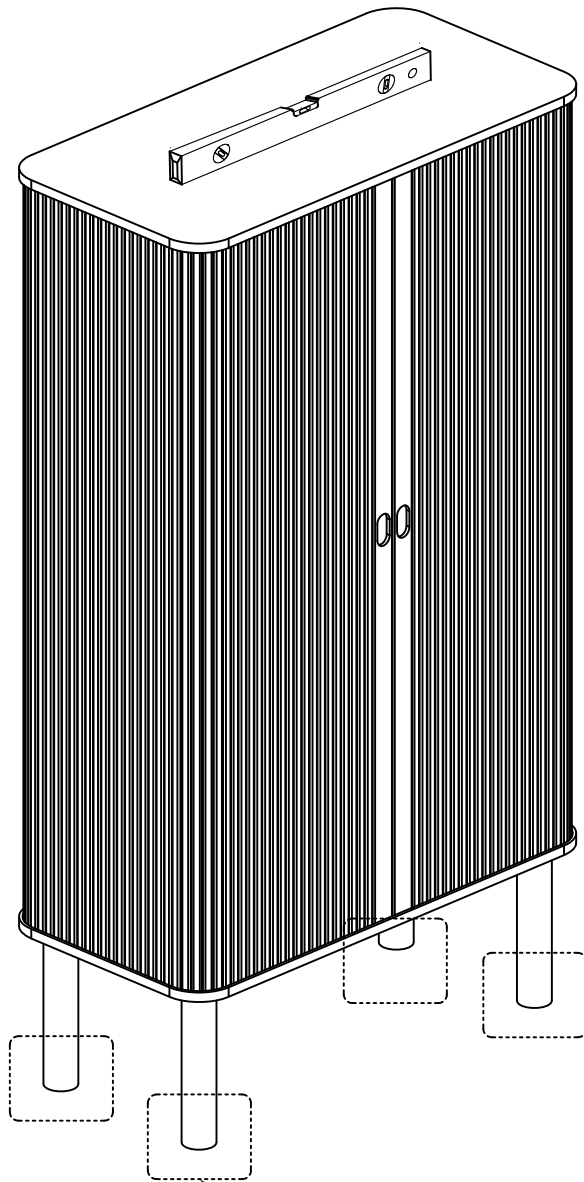
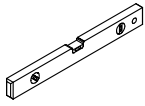

# 16

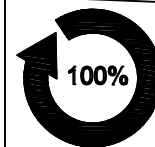
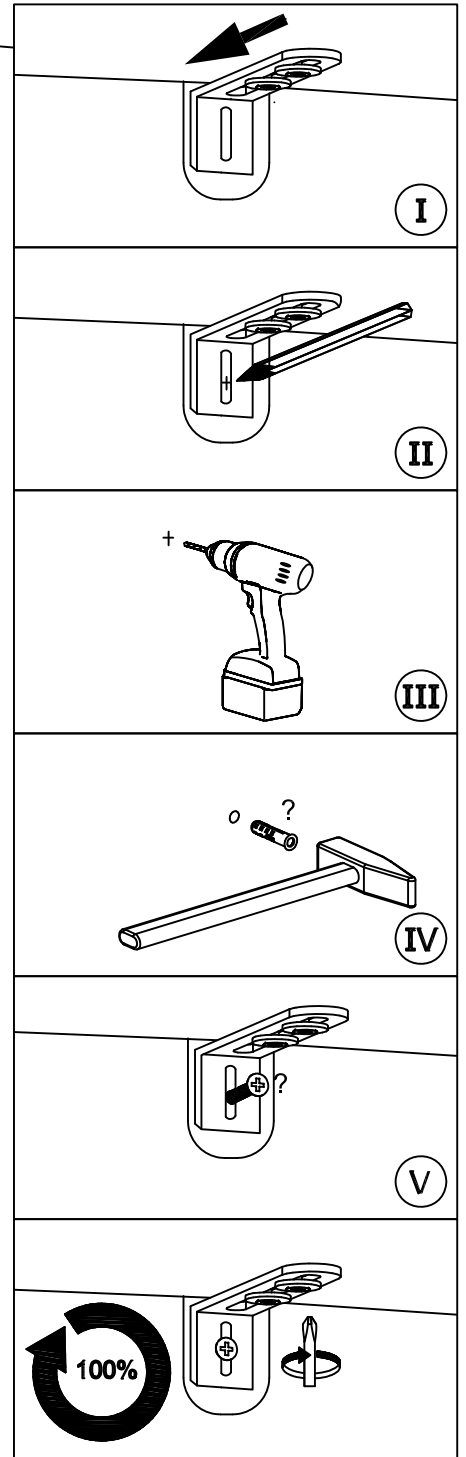
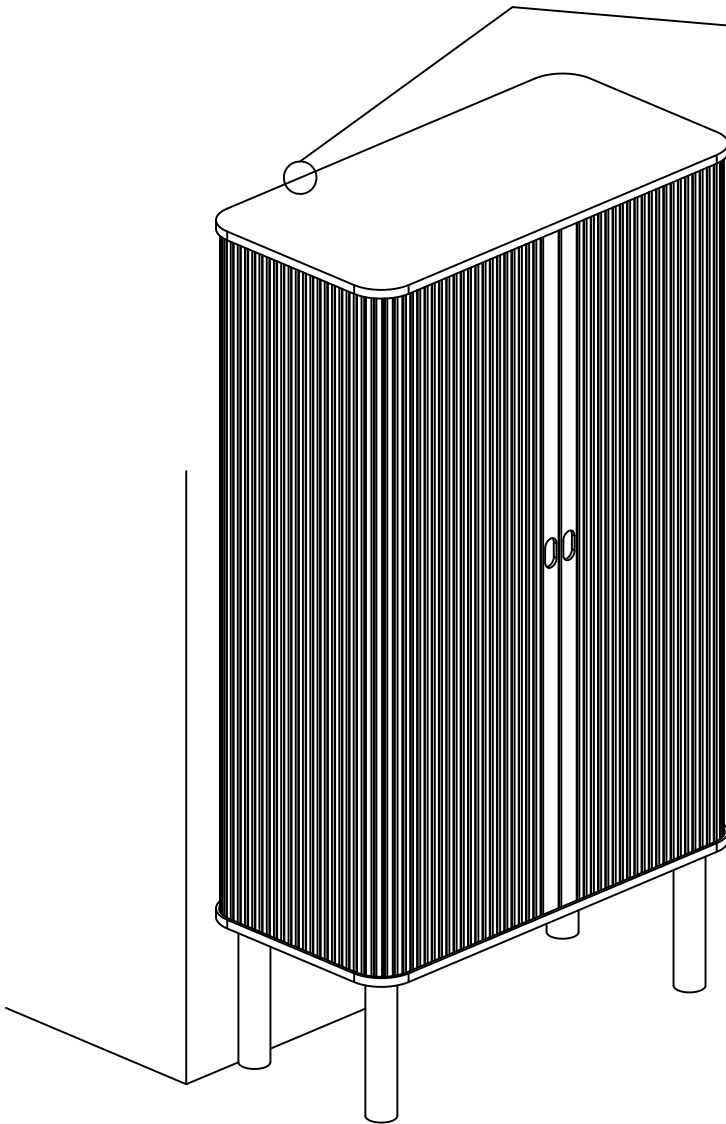
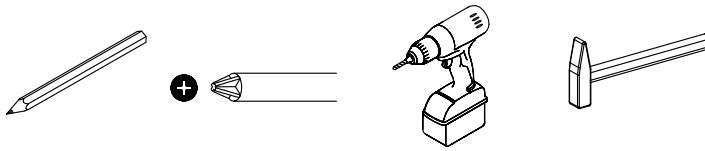

17

