





1

A x 1  M6x30 mm	D x 1  Ø6/Ø18 mm	E x 1  5 mm
--	---	--

	A  M6x30 mm	B  M6x48 mm	C  M6x20 mm
---	--	--	--



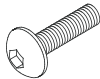
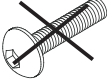
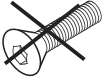
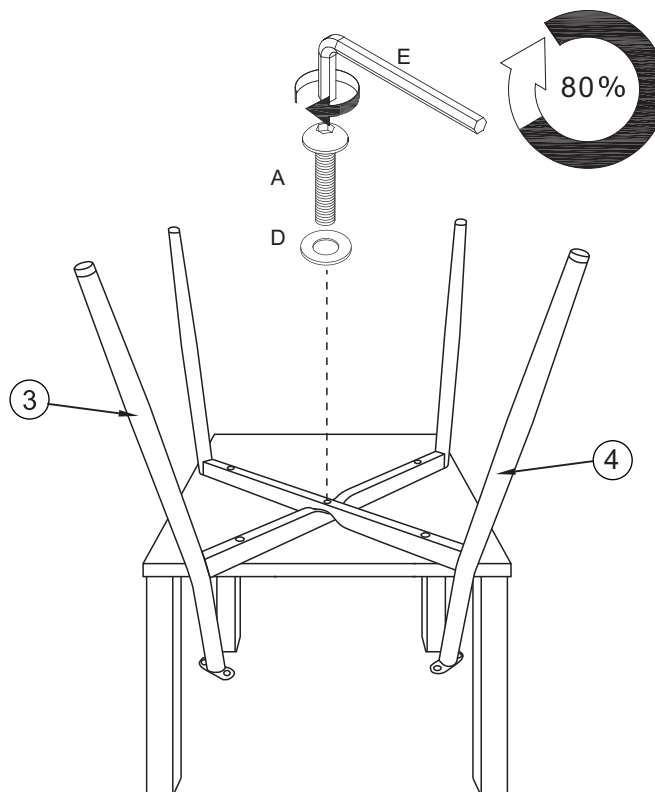

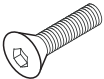
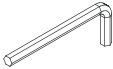
2

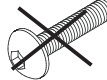
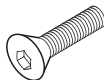
C x 4  M6x20 mm	E x 1  5 mm
--	--

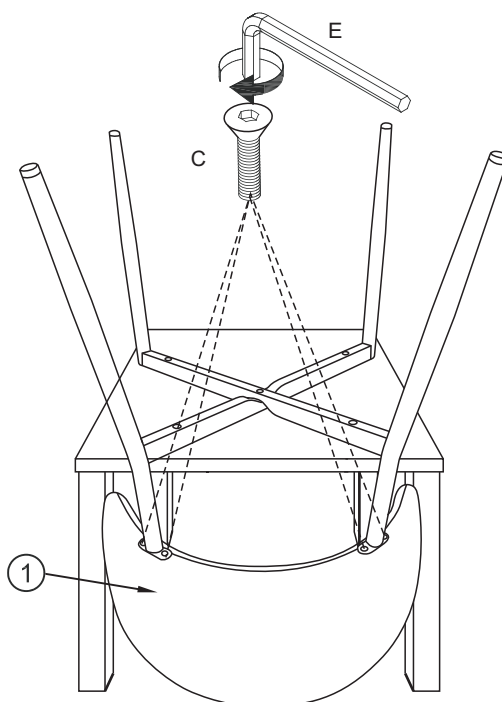
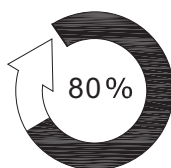
	B  M6x48 mm	C  M6x20 mm
---	--	--

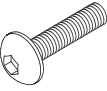

3

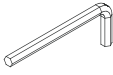
B x 4  M6x48 mm	D x 4  Ø6/Ø18 mm	E x 1  5 mm
--	---	--

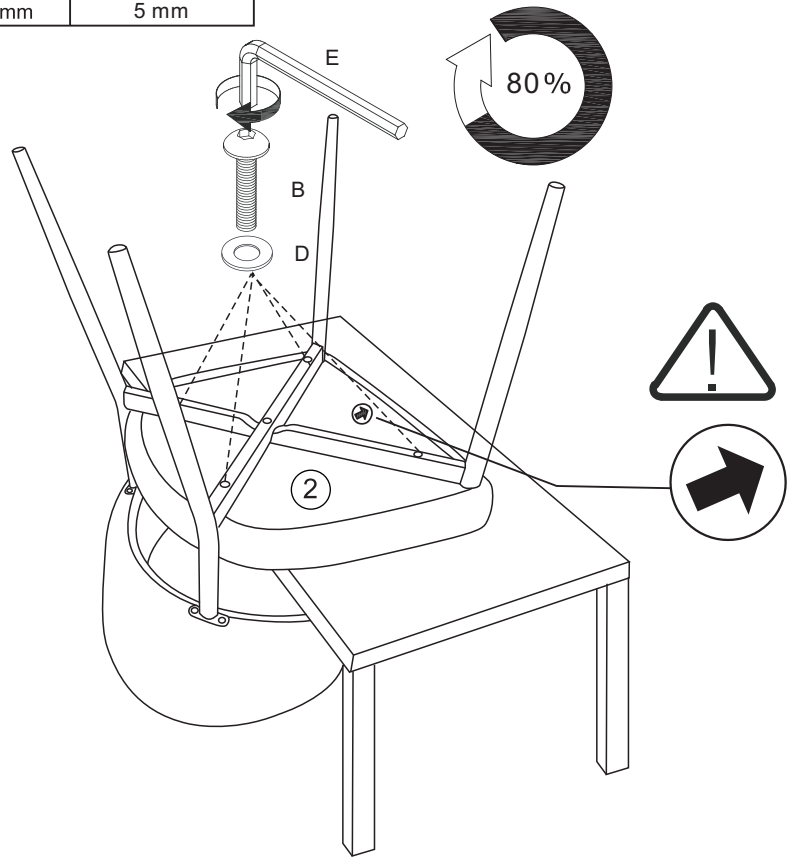

4

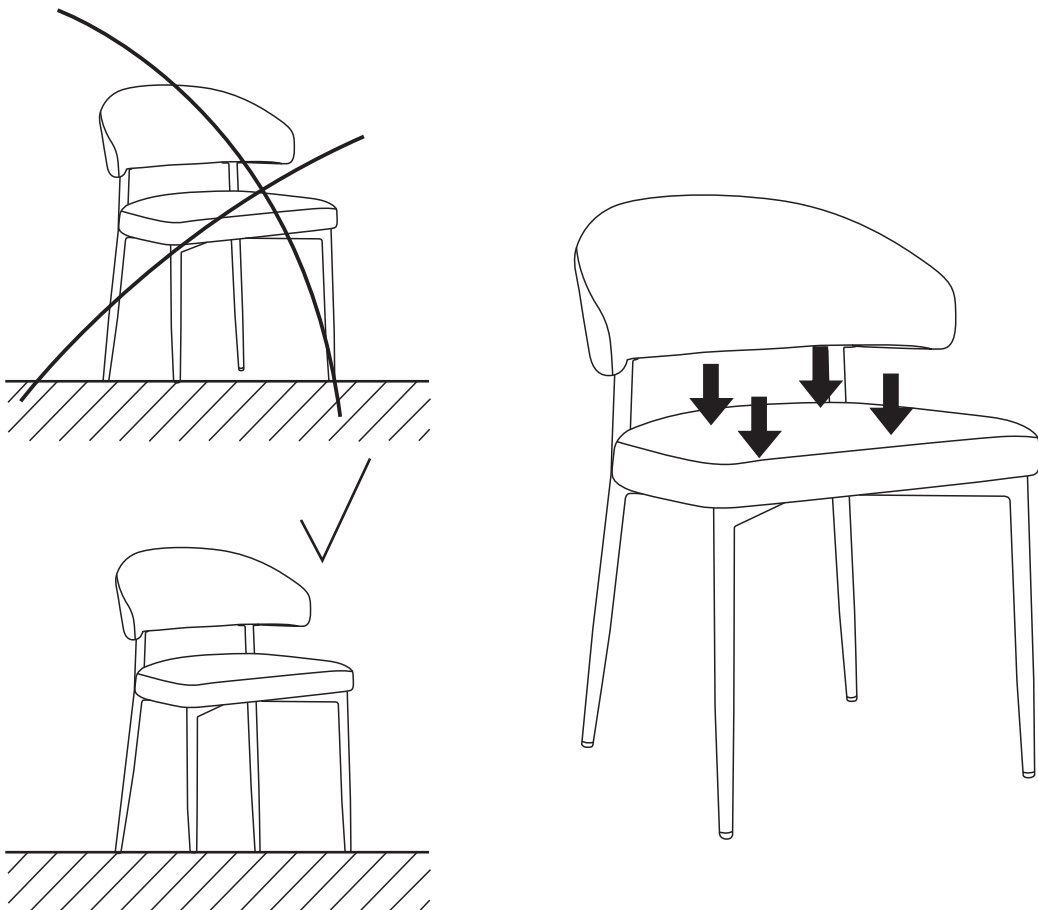

5

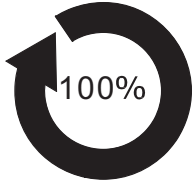
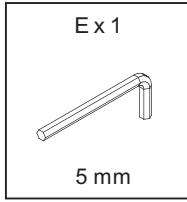

x9

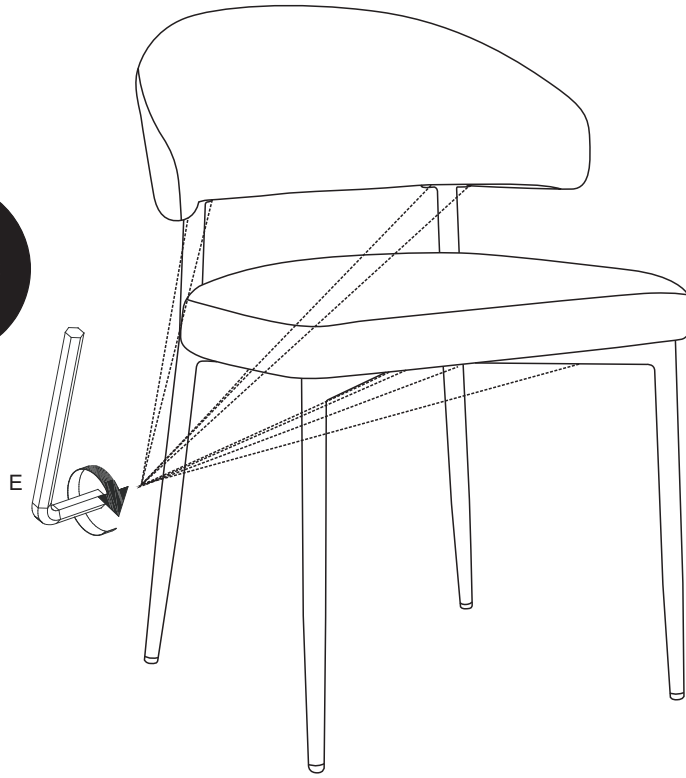

6

