

A1

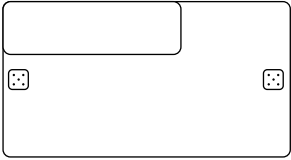

A2

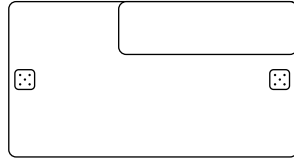

B1

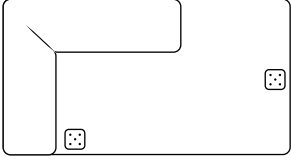

B2

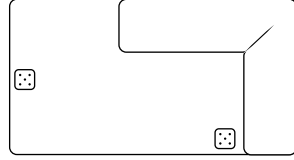

C1

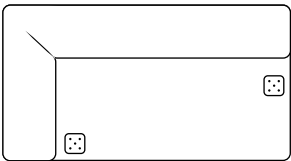

C2



D1

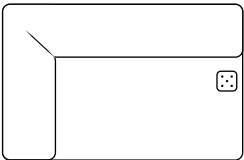

D2

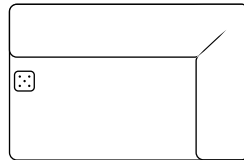

E1

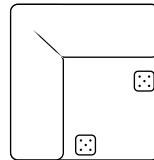

E2

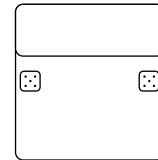

E3

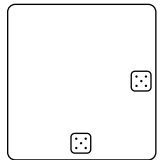

Ruby

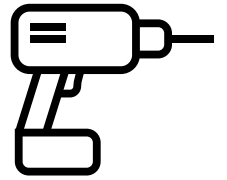
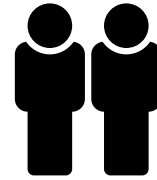

1

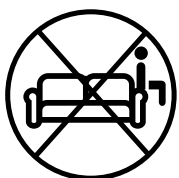
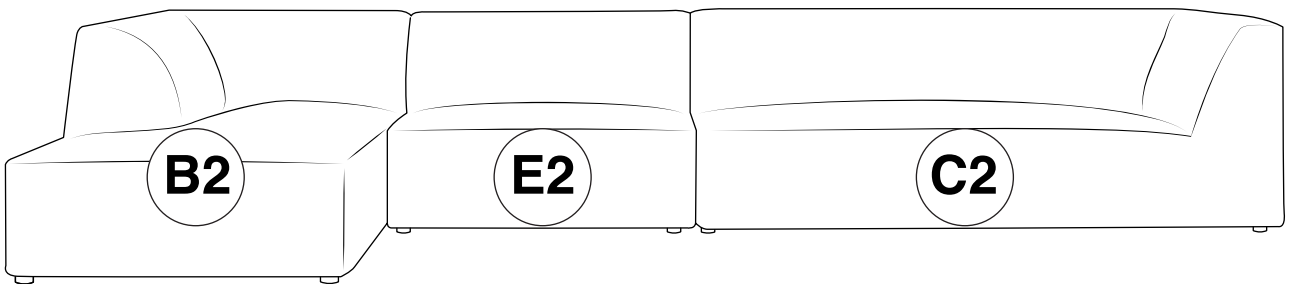

1 of 8

SHAPE UP ALL PILLOWS AND CUSHIONS!

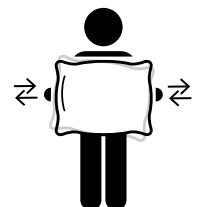

2: D+D

Ruby

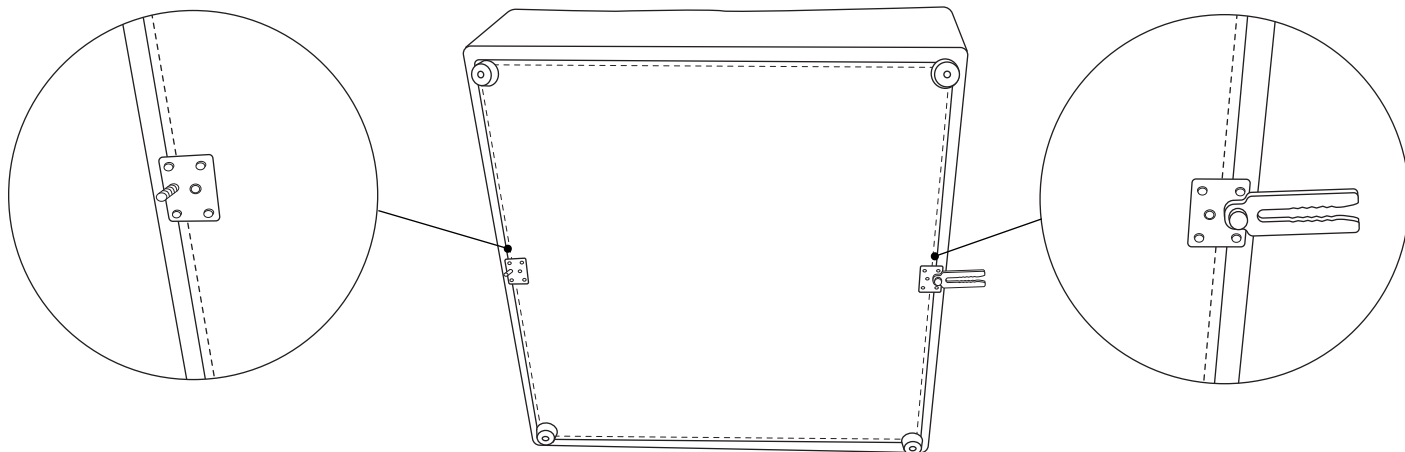

D1 + D2

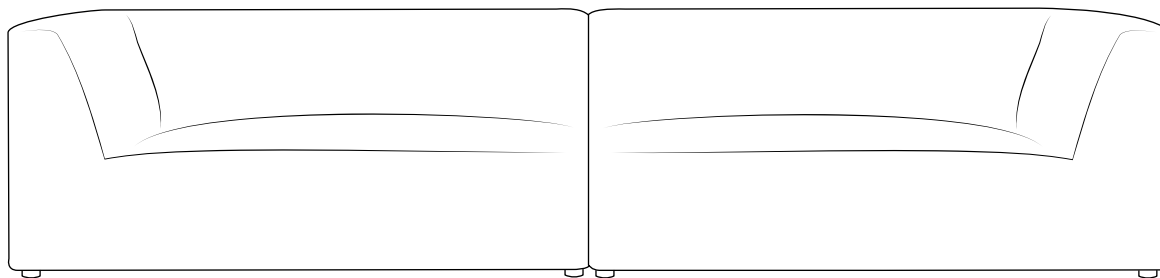
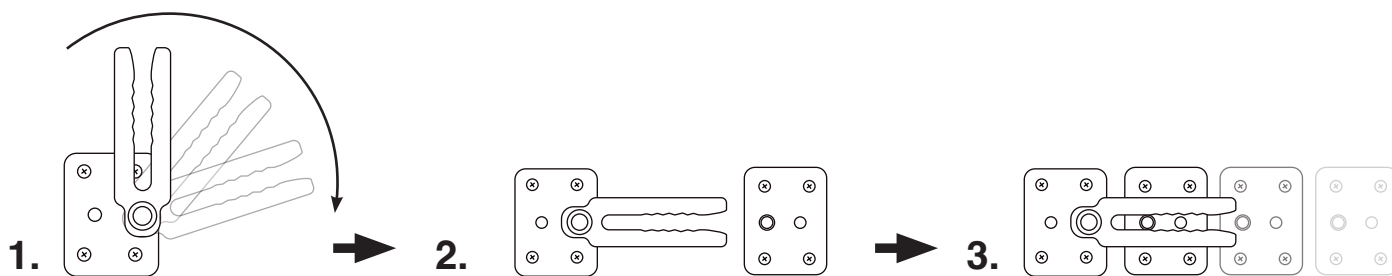
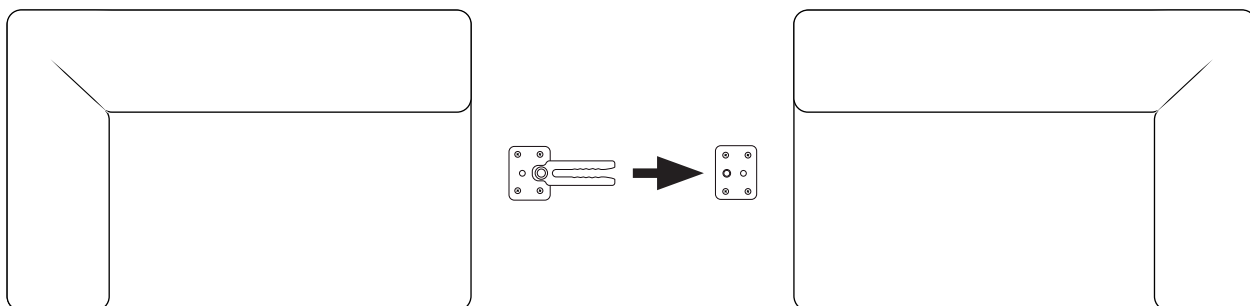

3: A+B

Ruby

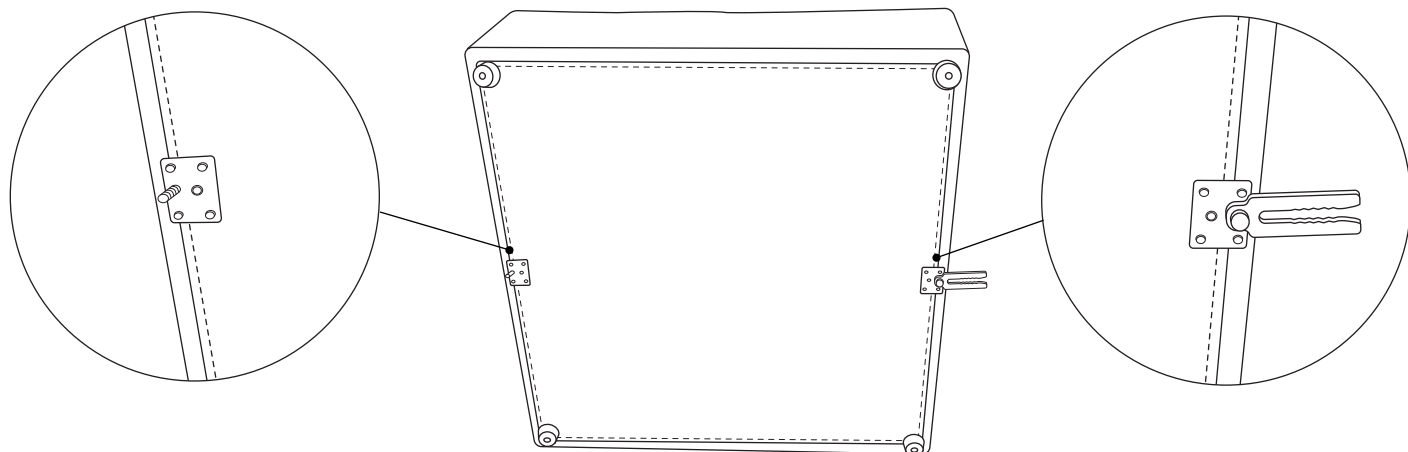

A2 + B1

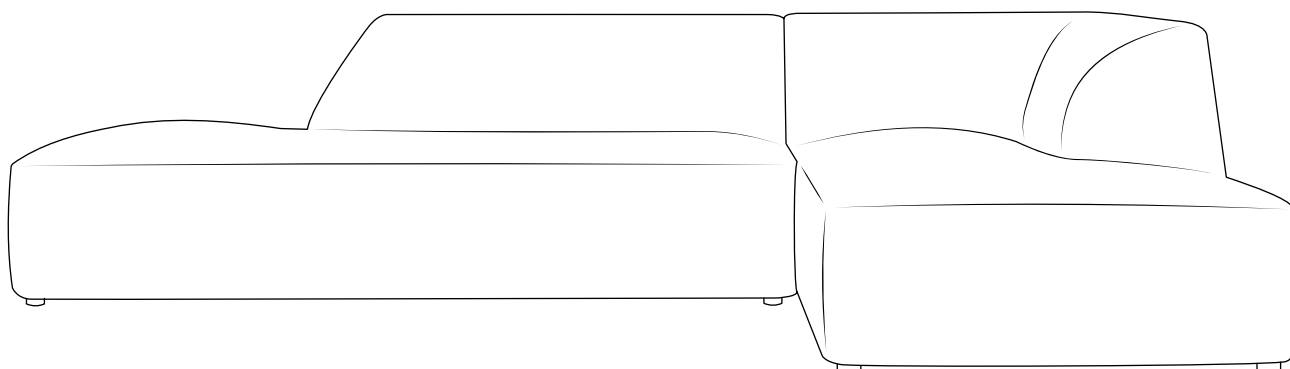
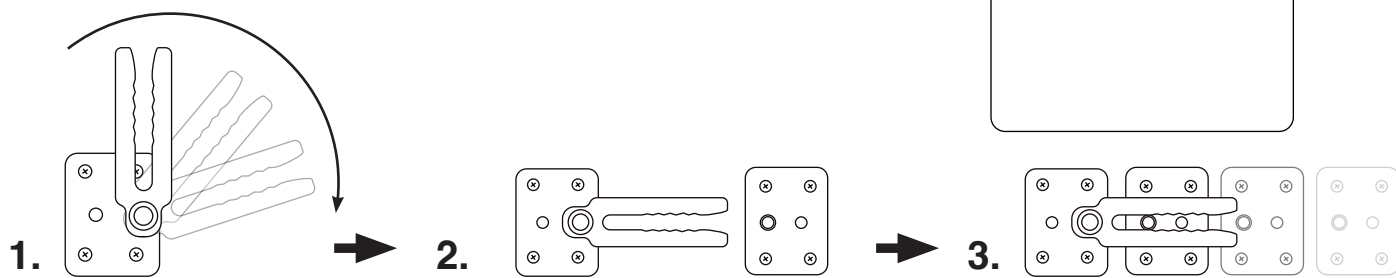
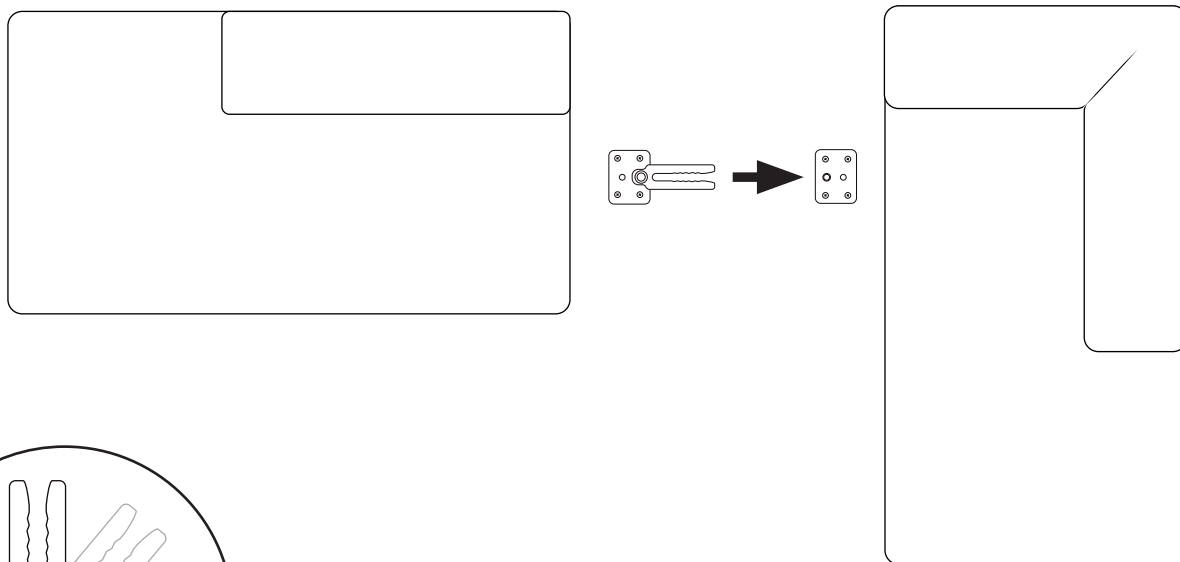

4: C+B

Ruby

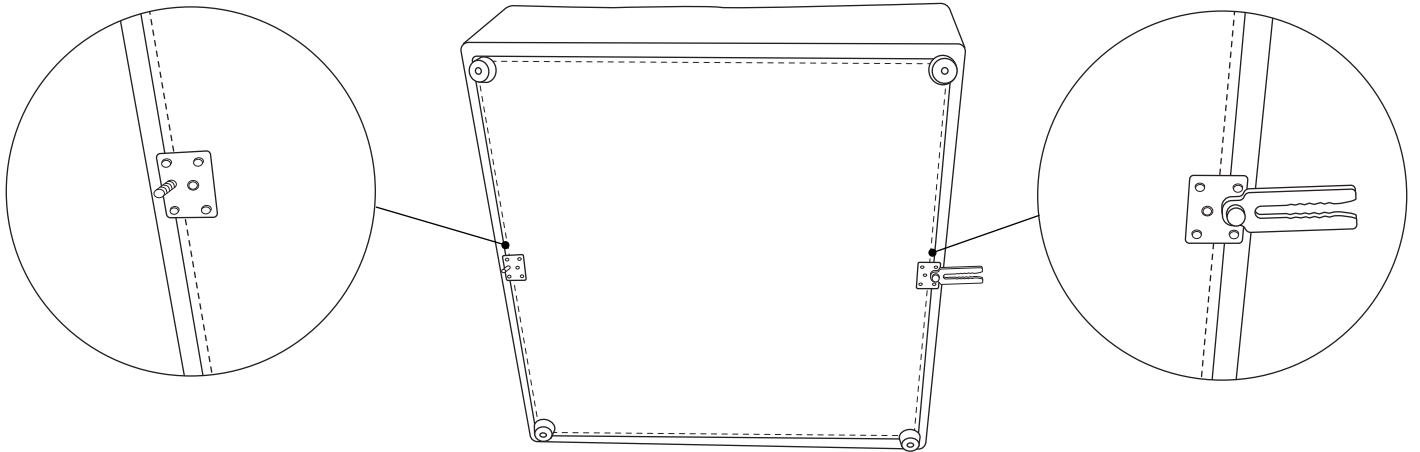

C1 + B1

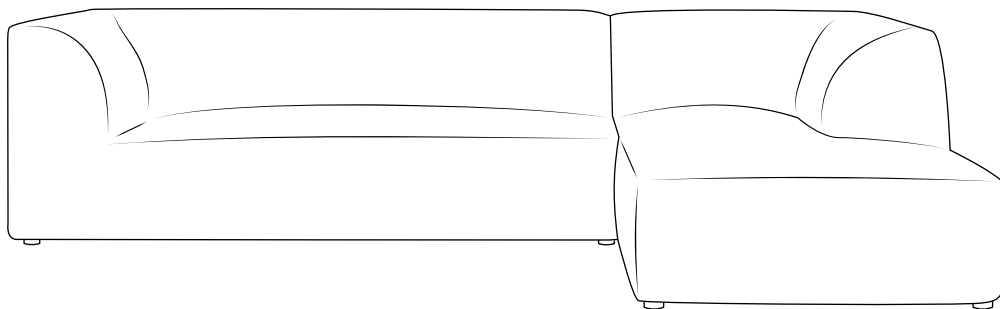
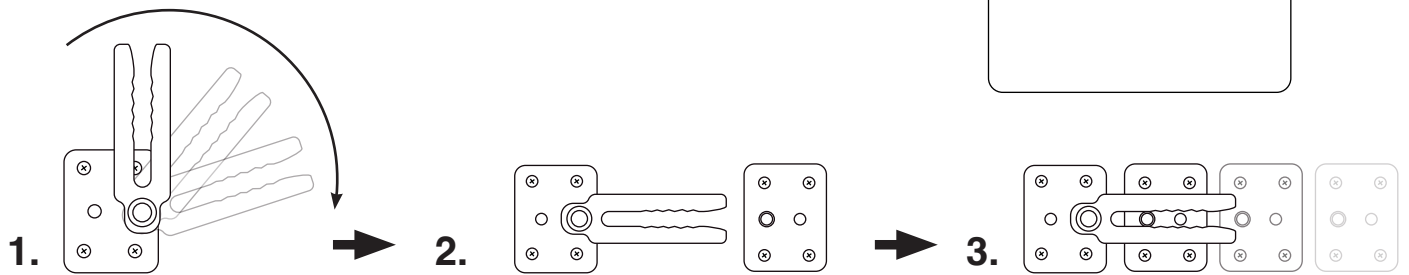
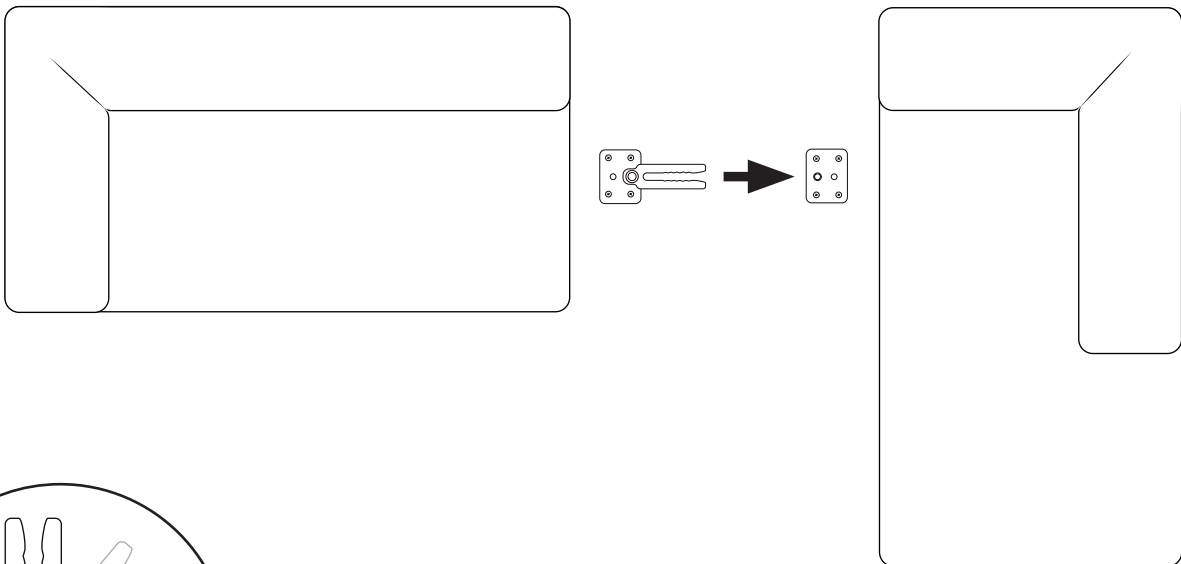

5: E+B

Ruby

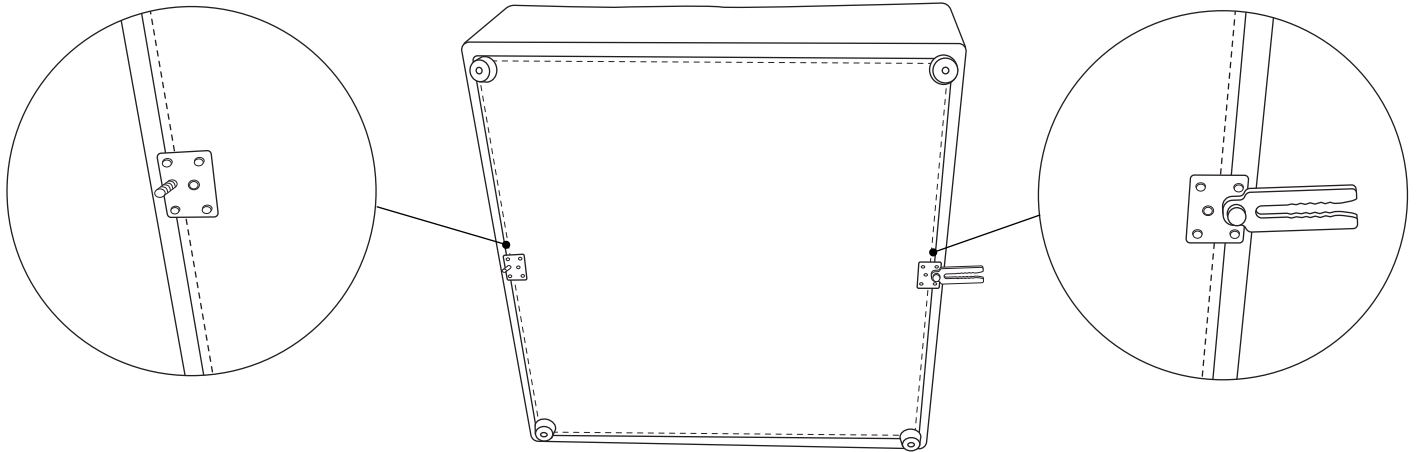

E1 + B1

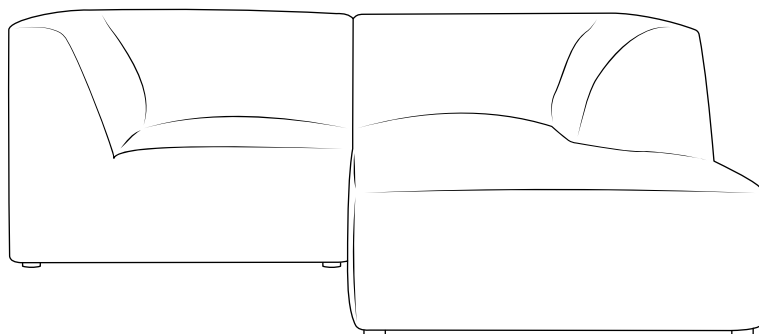
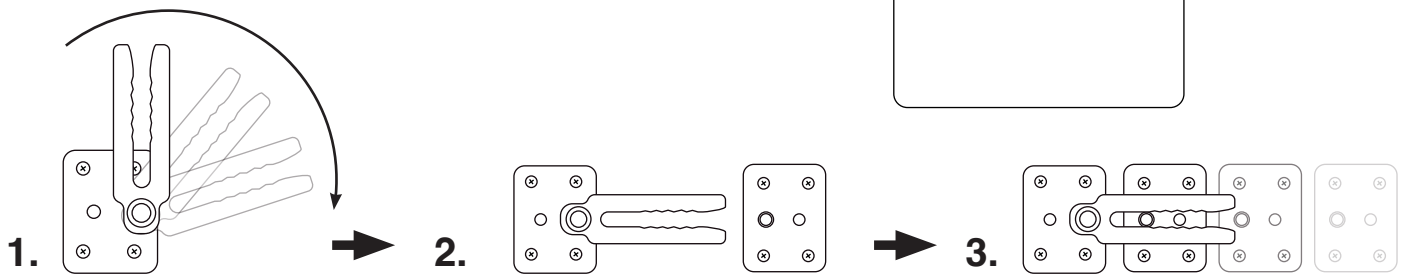
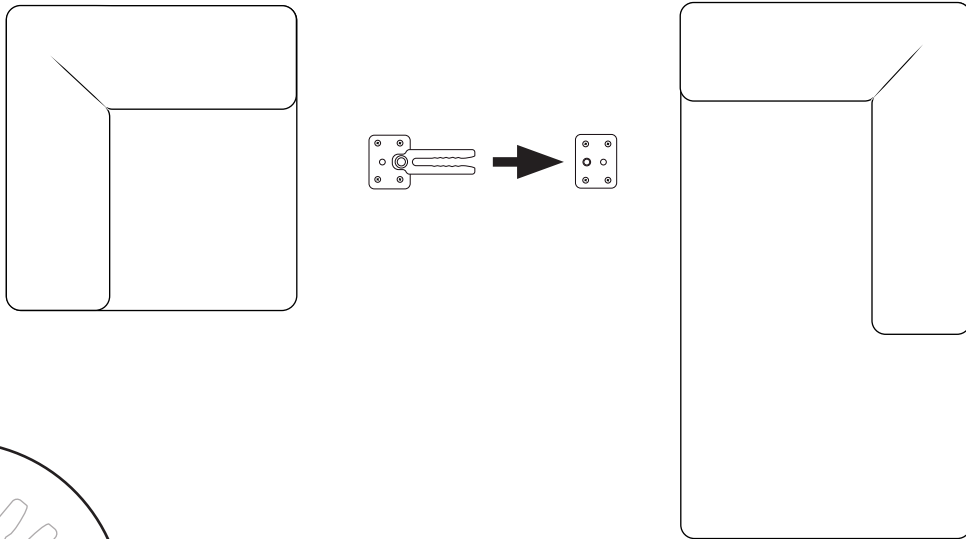

6: B+E+C

Ruby

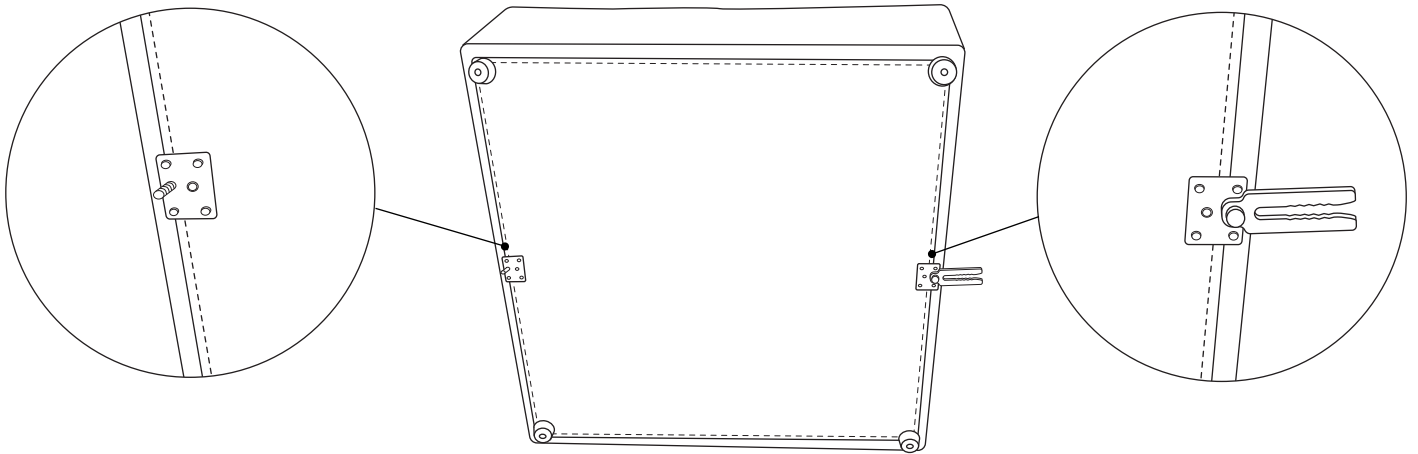

B2 + E2 + C2

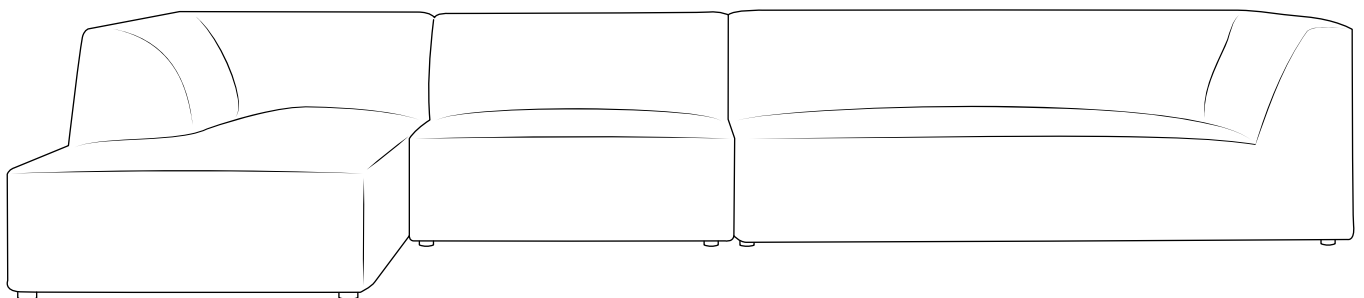
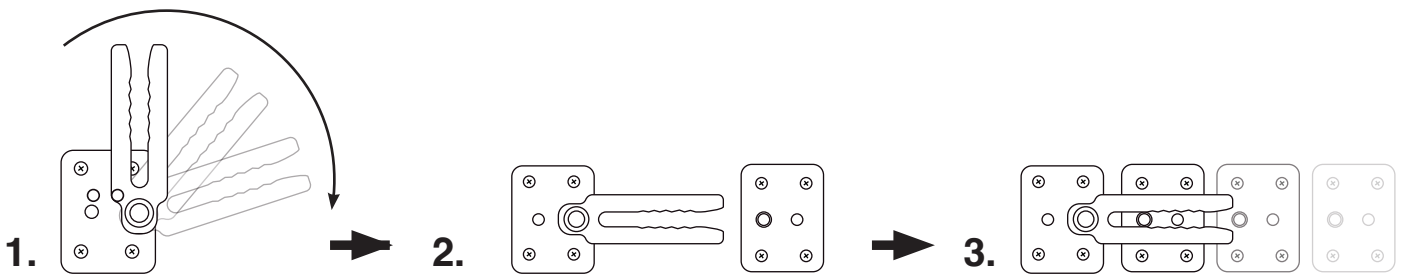
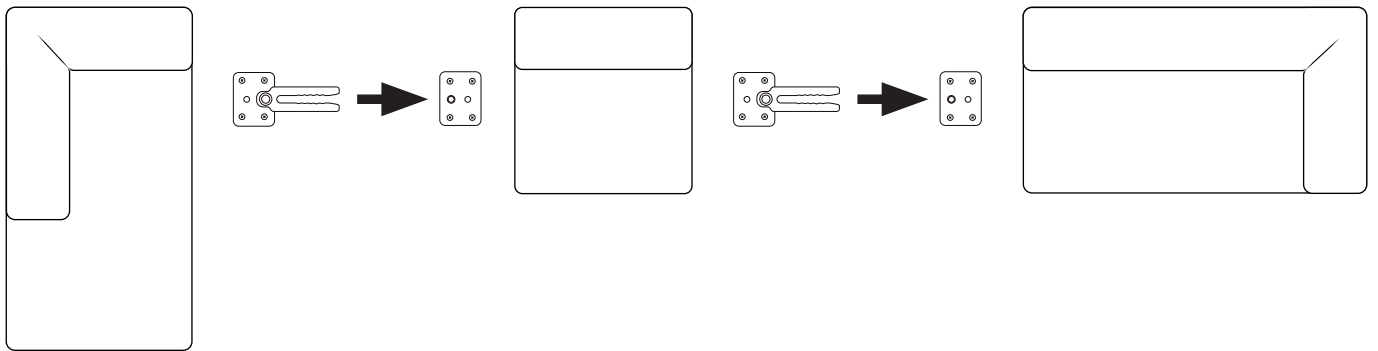

7: C+E+B

Ruby

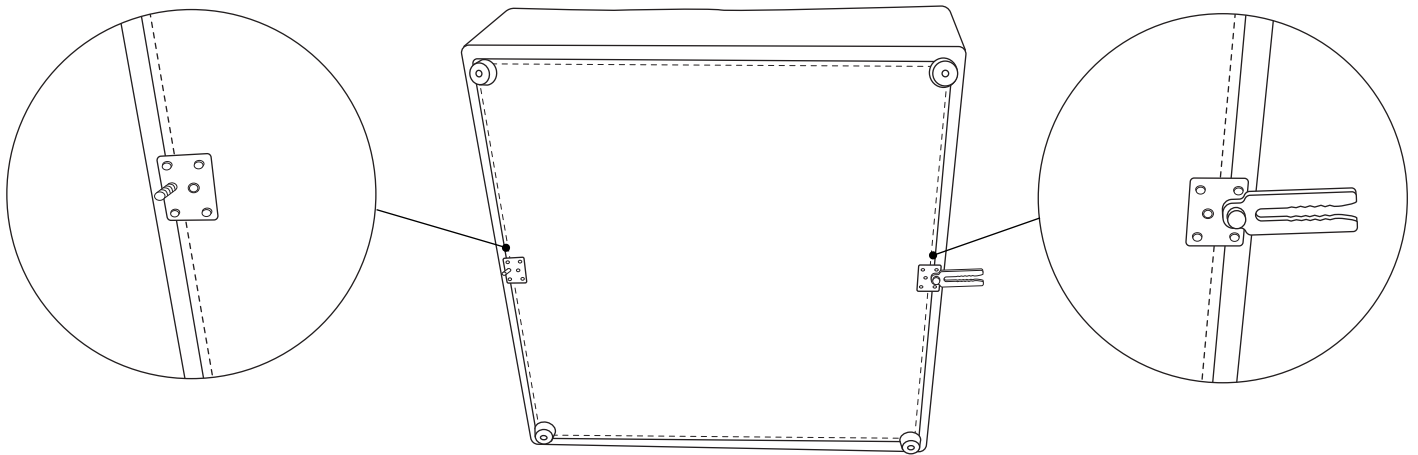

C1 + E2 + B1

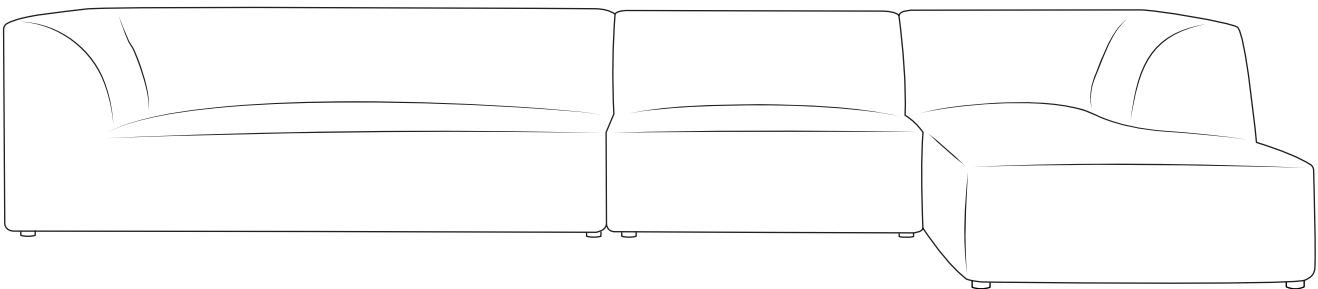
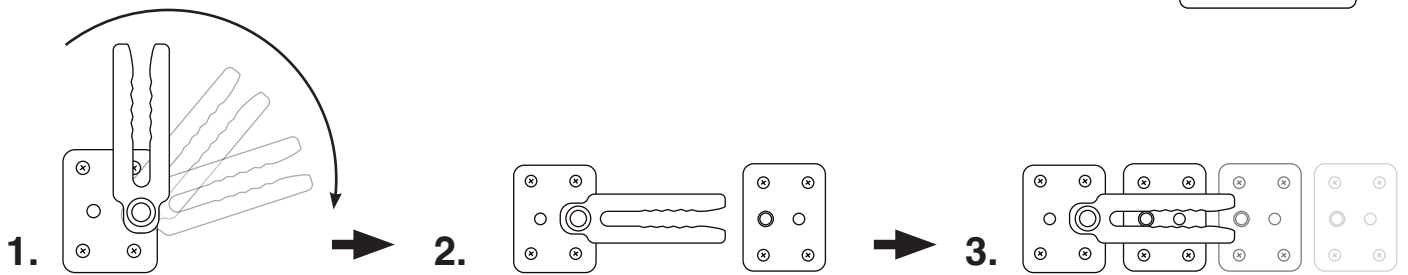
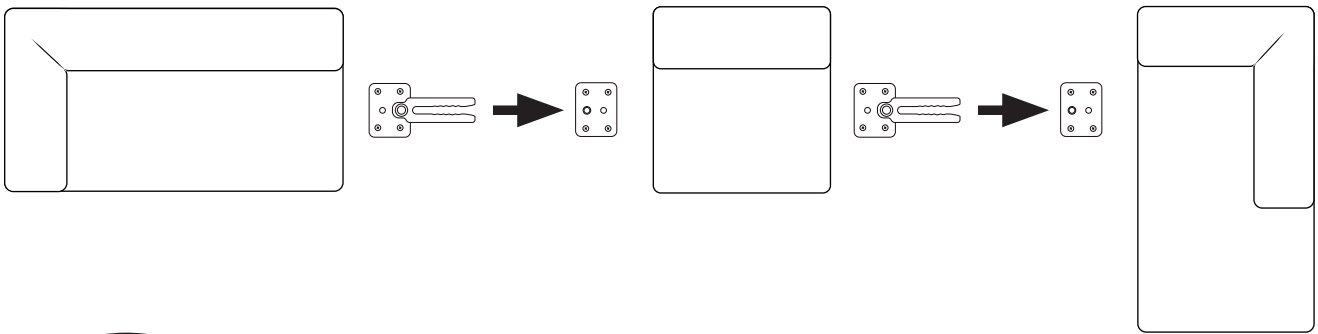

8: A+C+E+B

Ruby

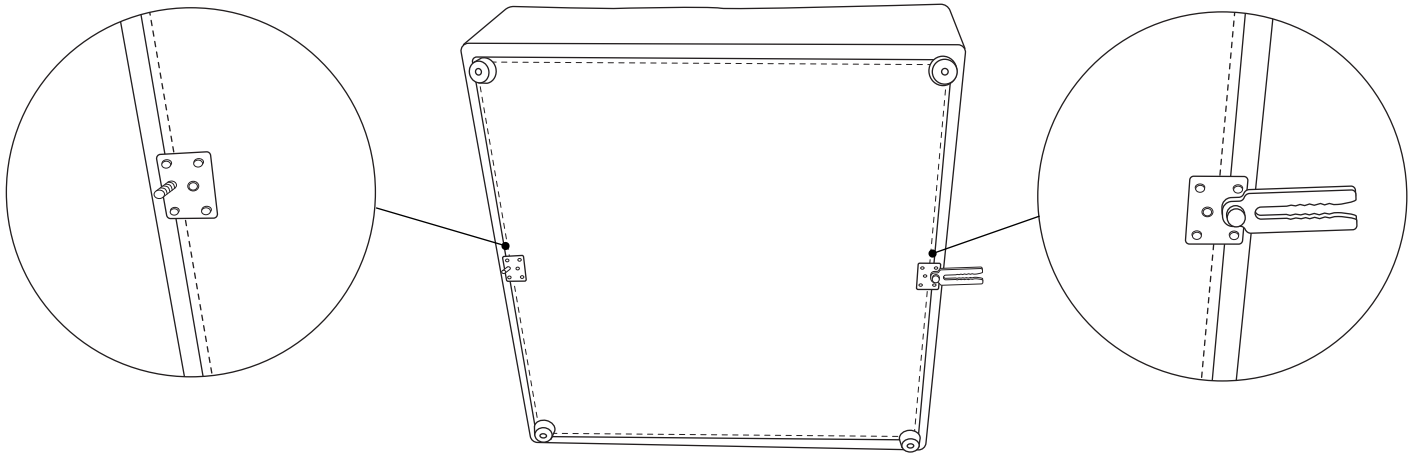

A2 + C1 + E2 + B1

