

Mike

sofa

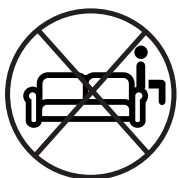
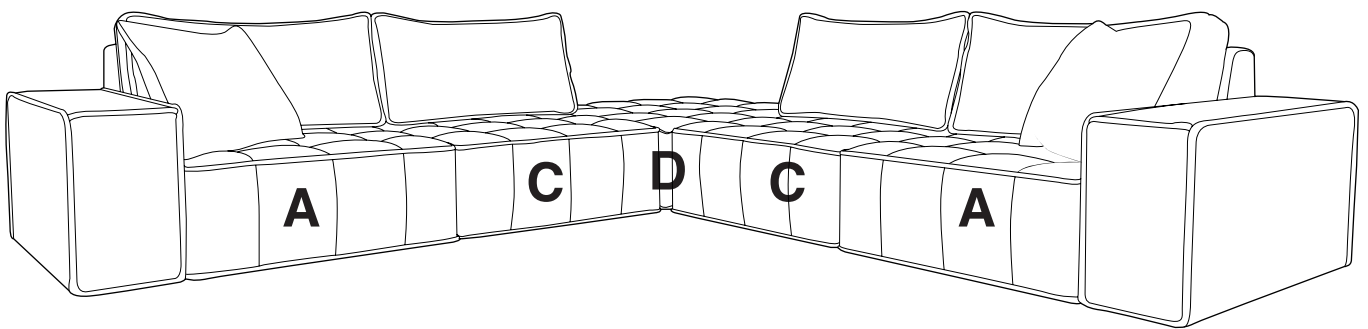
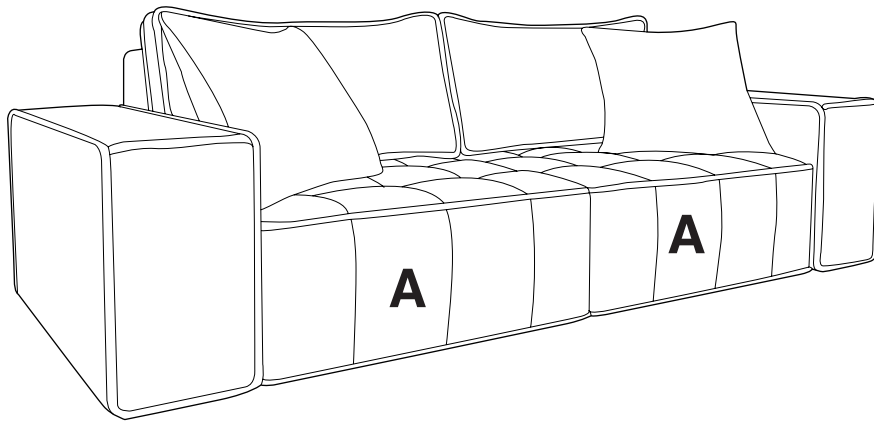
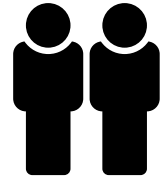

1 of 8

SHAPE UP ALL PILLOWS AND CUSHIONS!

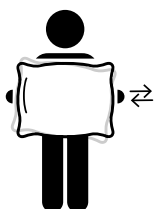

1: 2x A

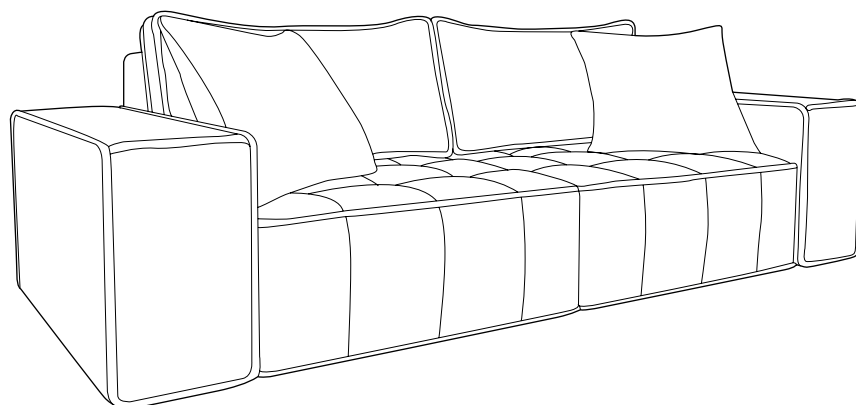
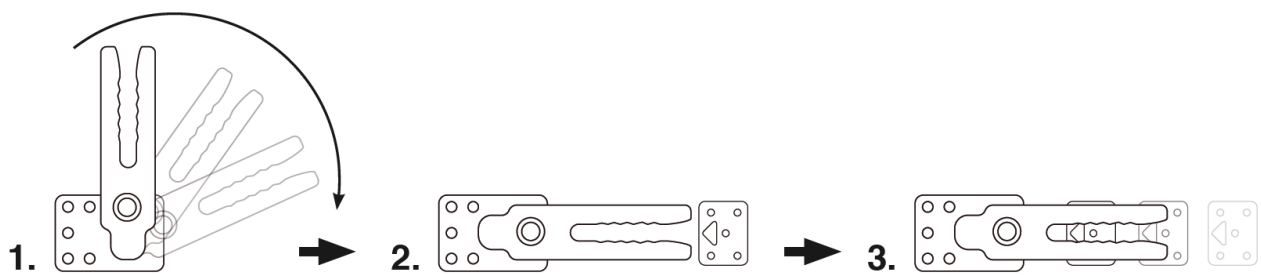
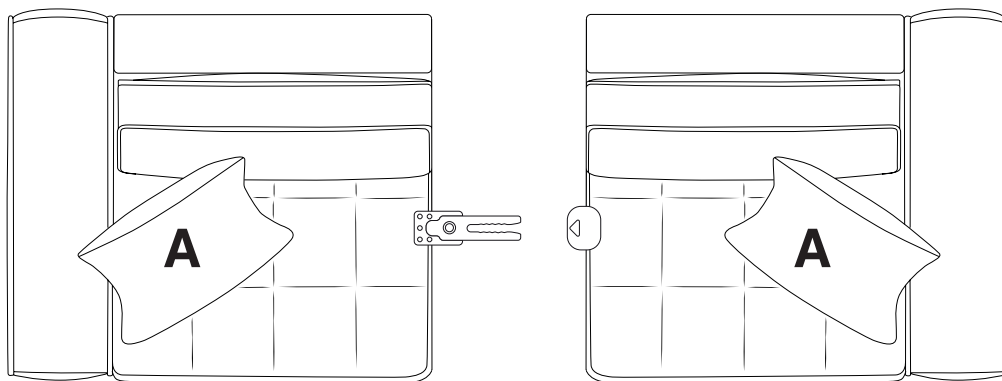
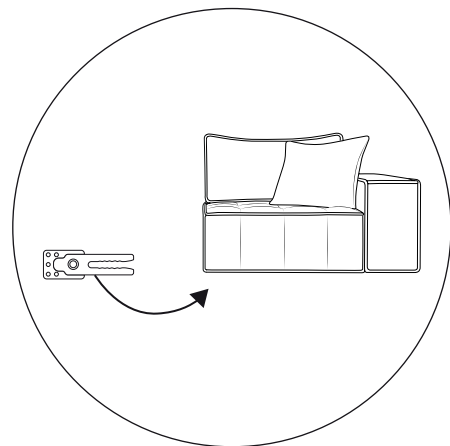
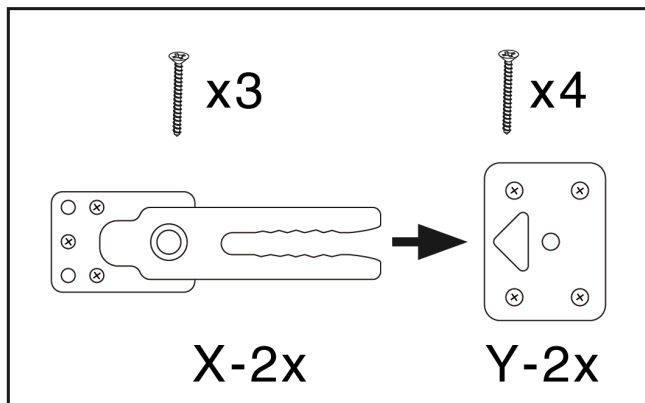

2: 2x A + C

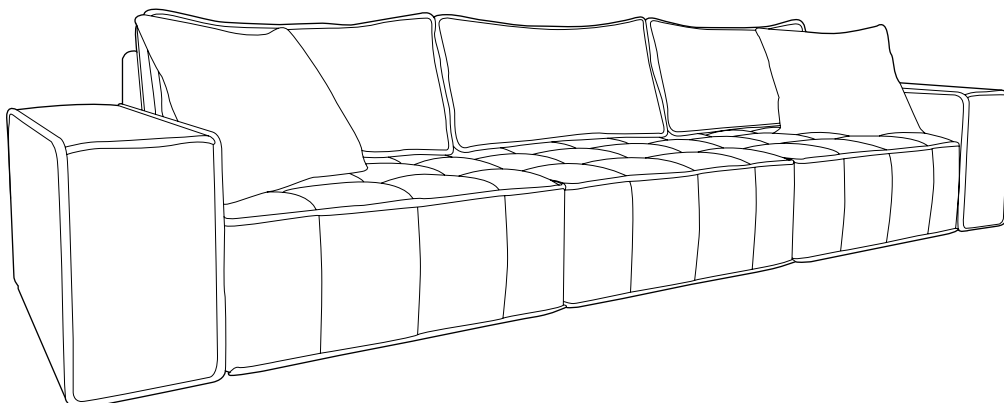
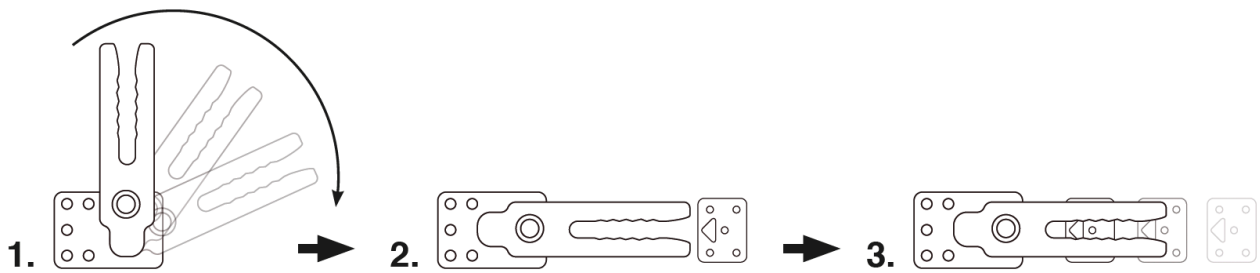
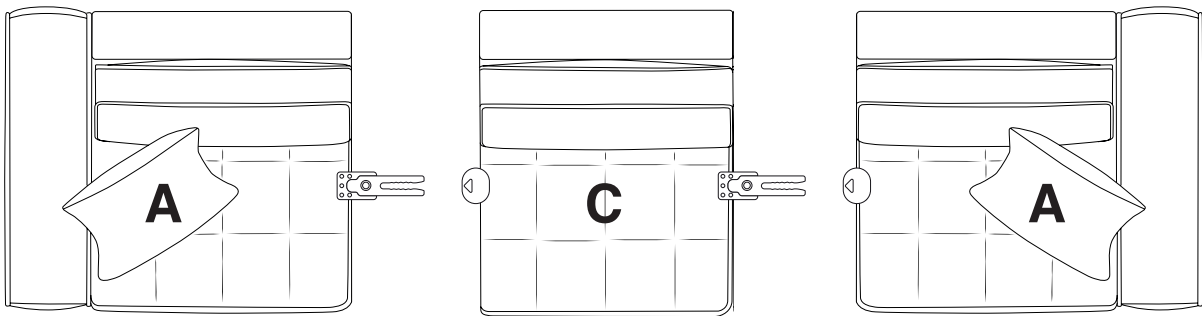
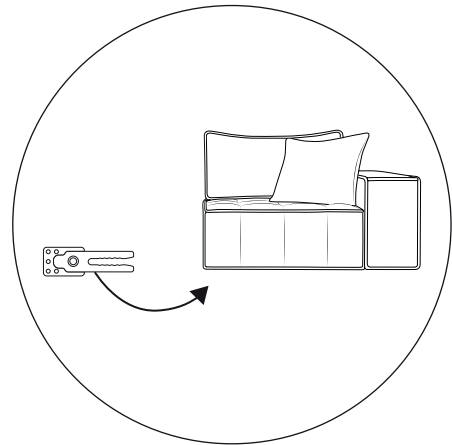
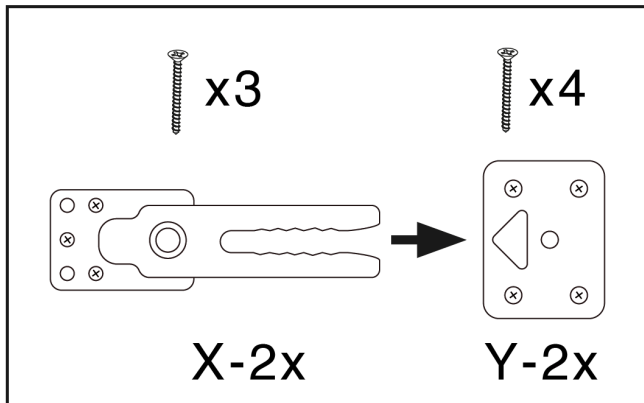

3: 2x C

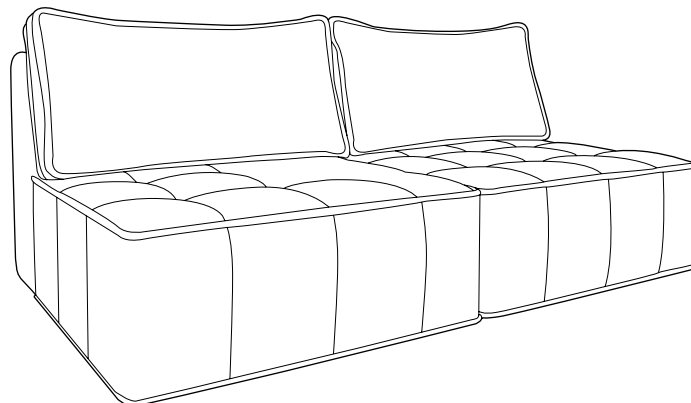
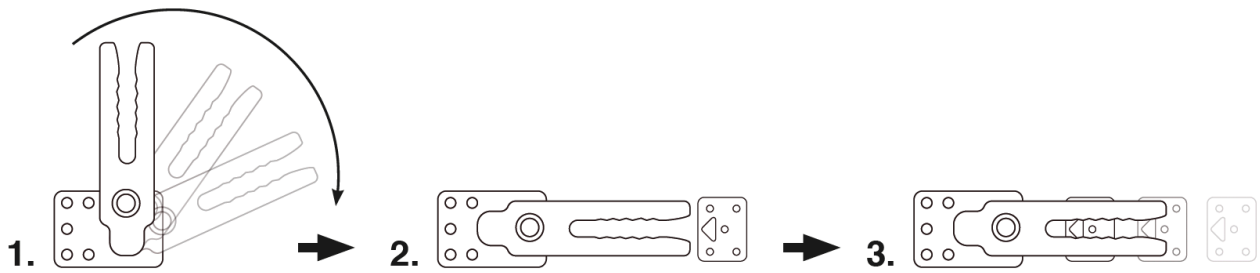
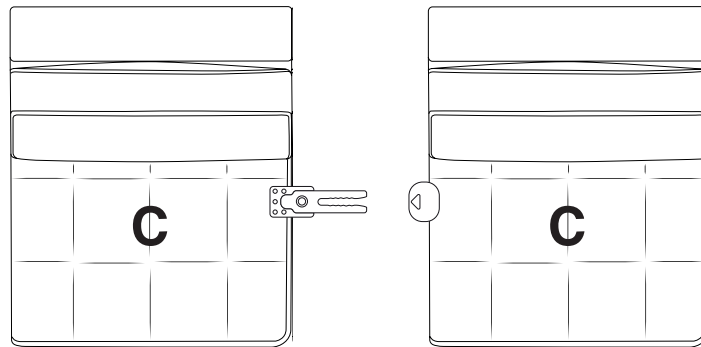
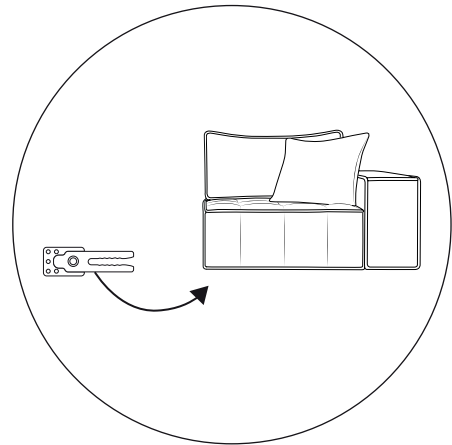
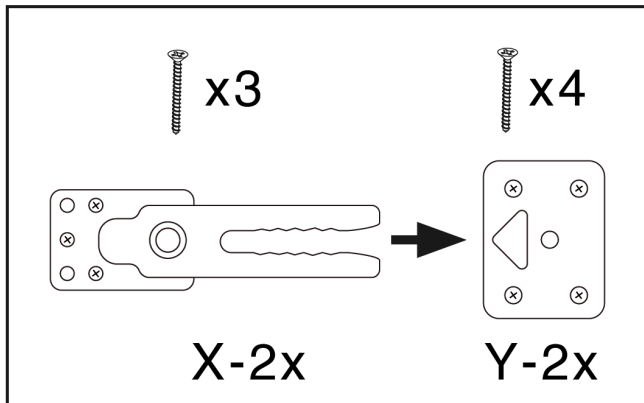

4: A + B + C

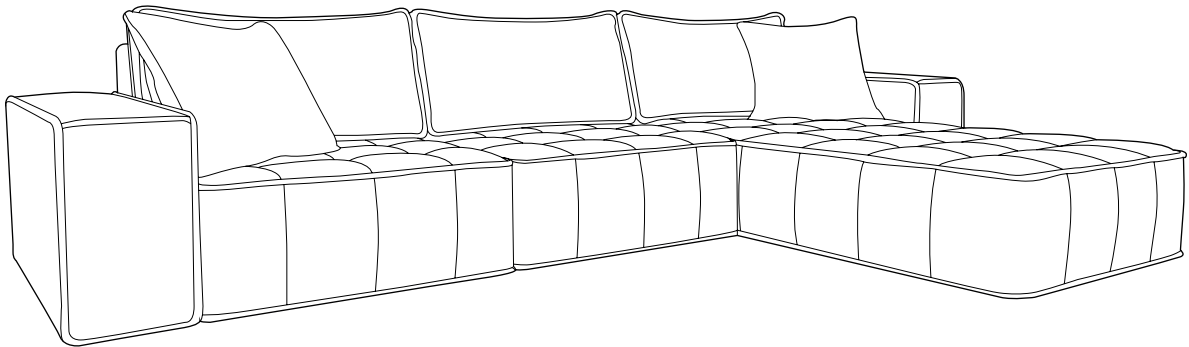
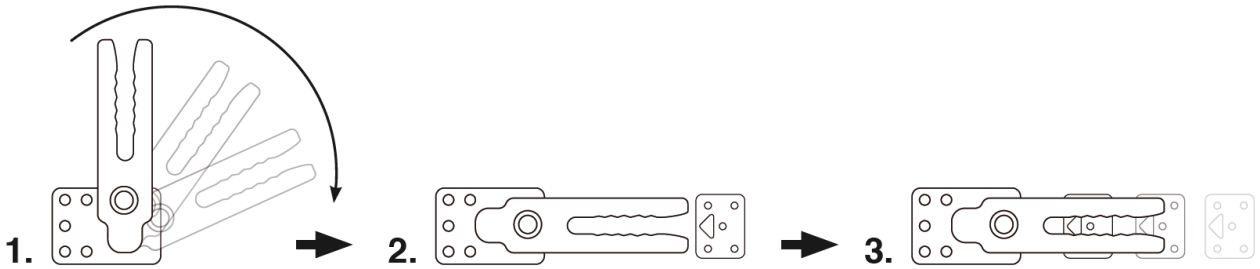
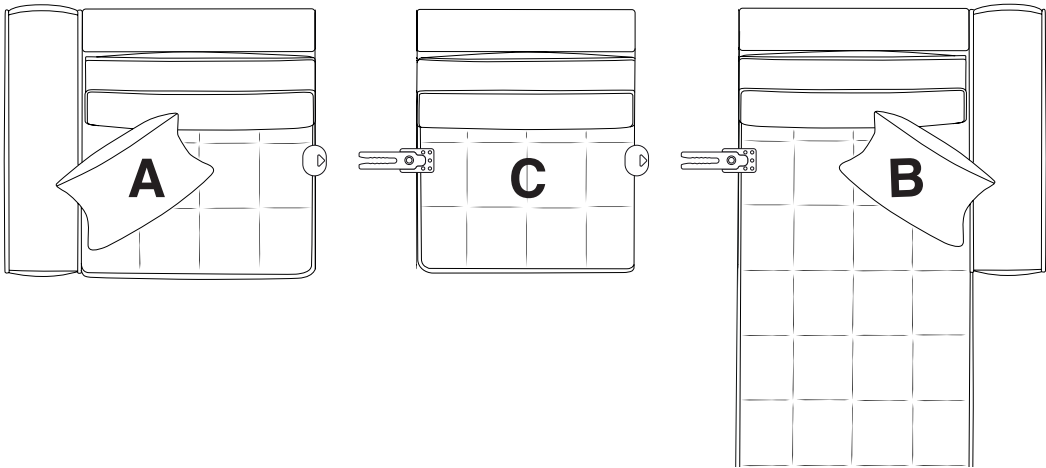
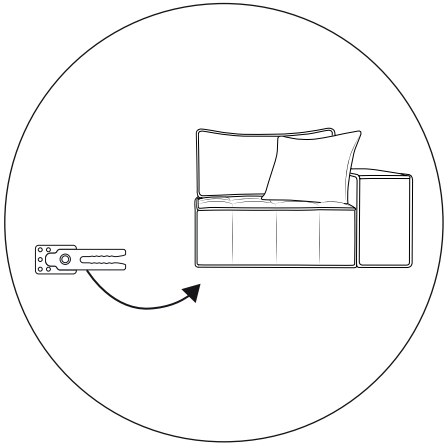
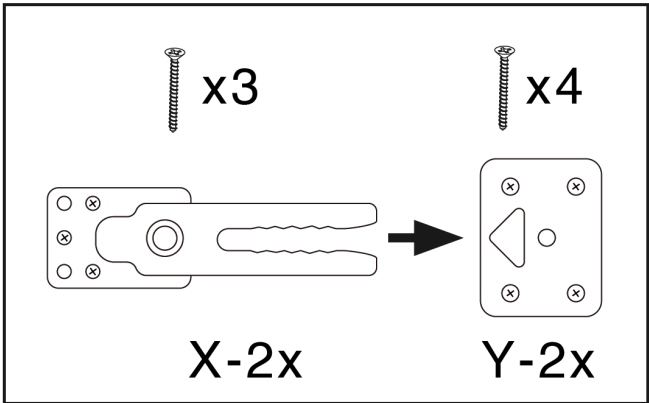

5: 2x B + 2x C

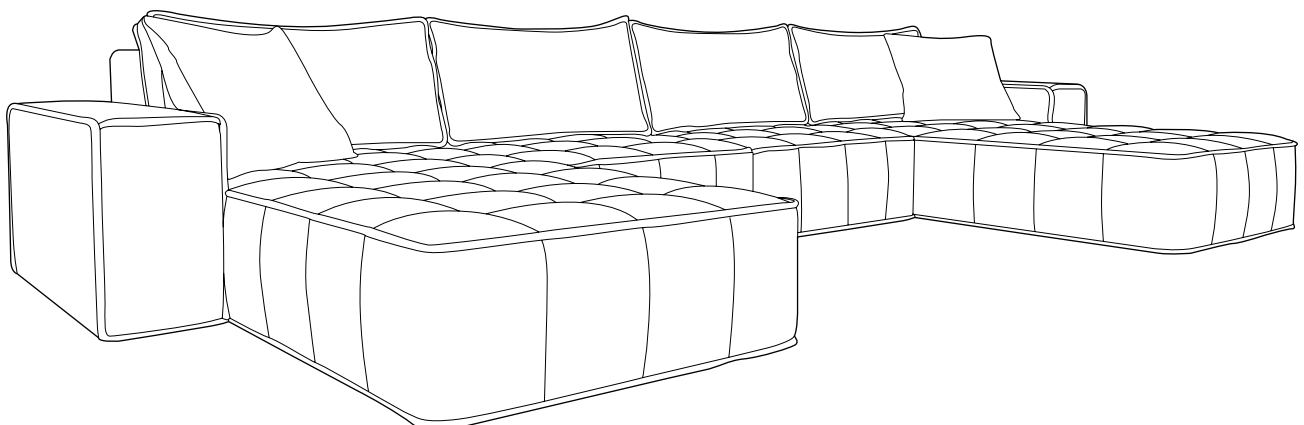
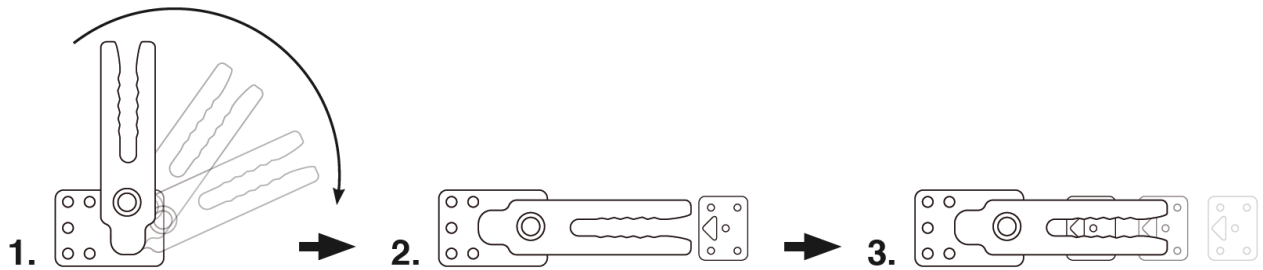
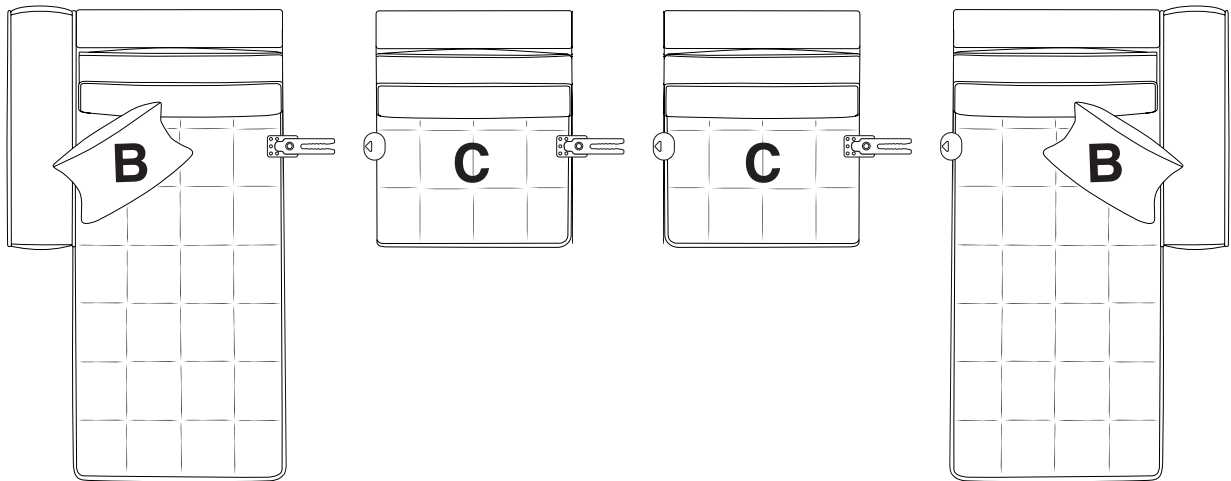
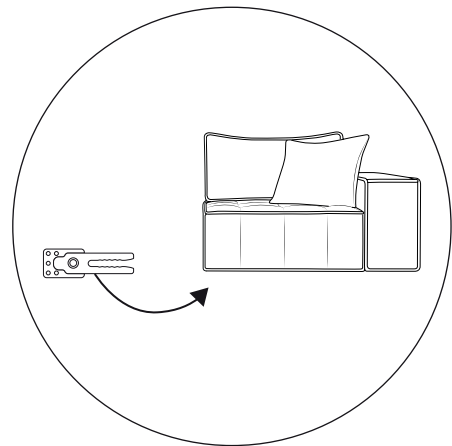
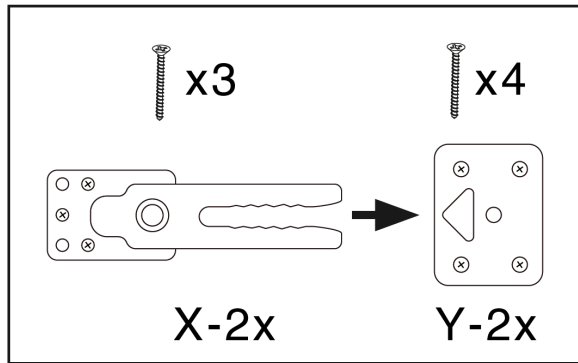

6: 2x A + 2x C + D

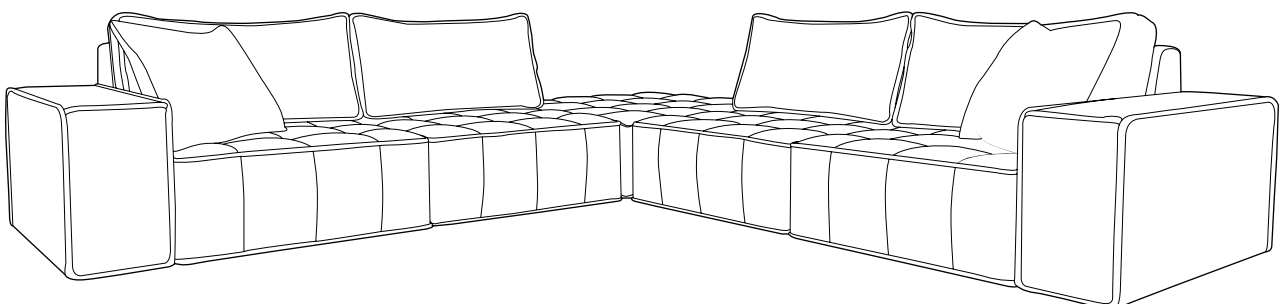
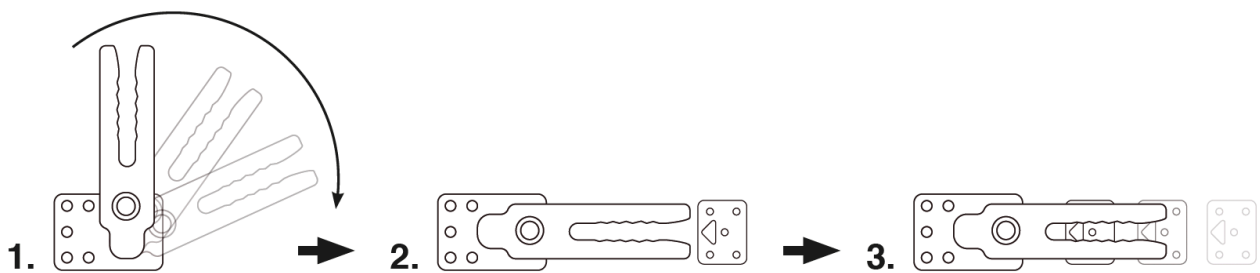
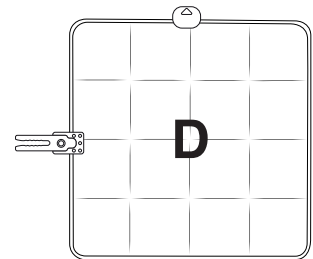
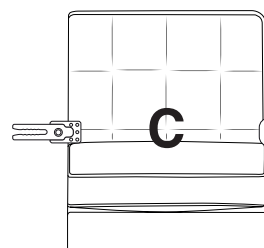
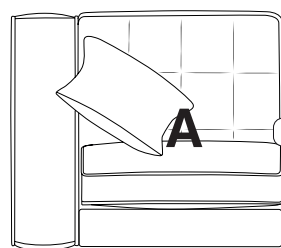
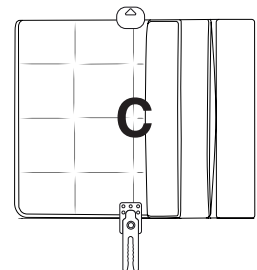
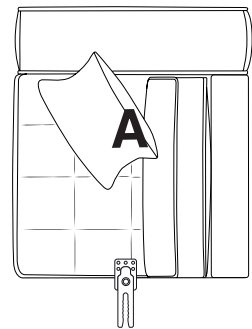
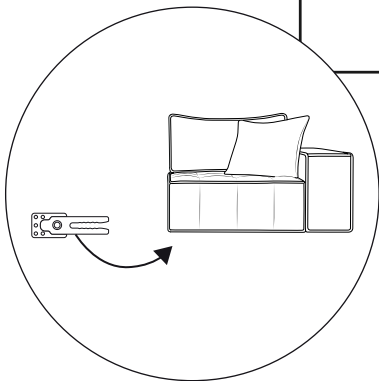
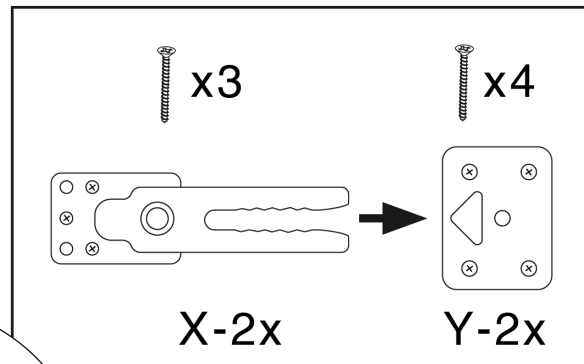

7: A + B + 3x C + D

