

Moghan

sofa

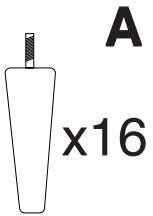

A

x16

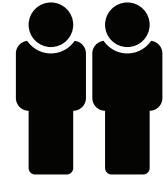

* the installation method for a right and left-sided sofa is analogous.

1

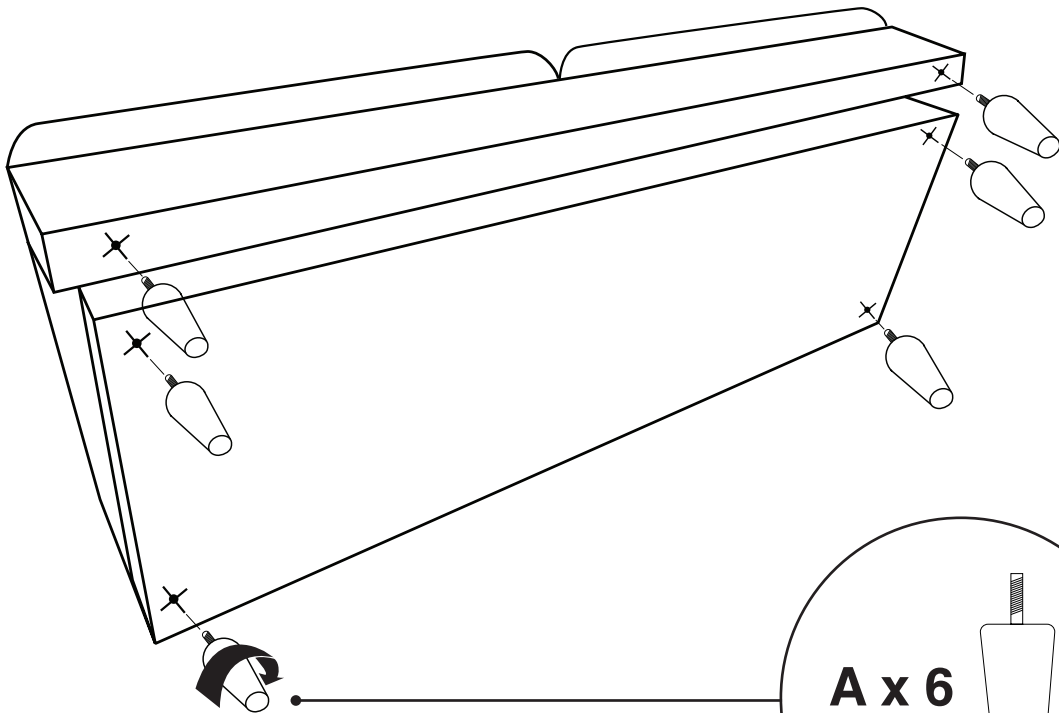

A x 6



1 of 9

SHAPE UP ALL PILLOWS AND CUSHIONS!

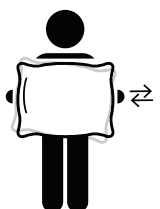

2

C x 2

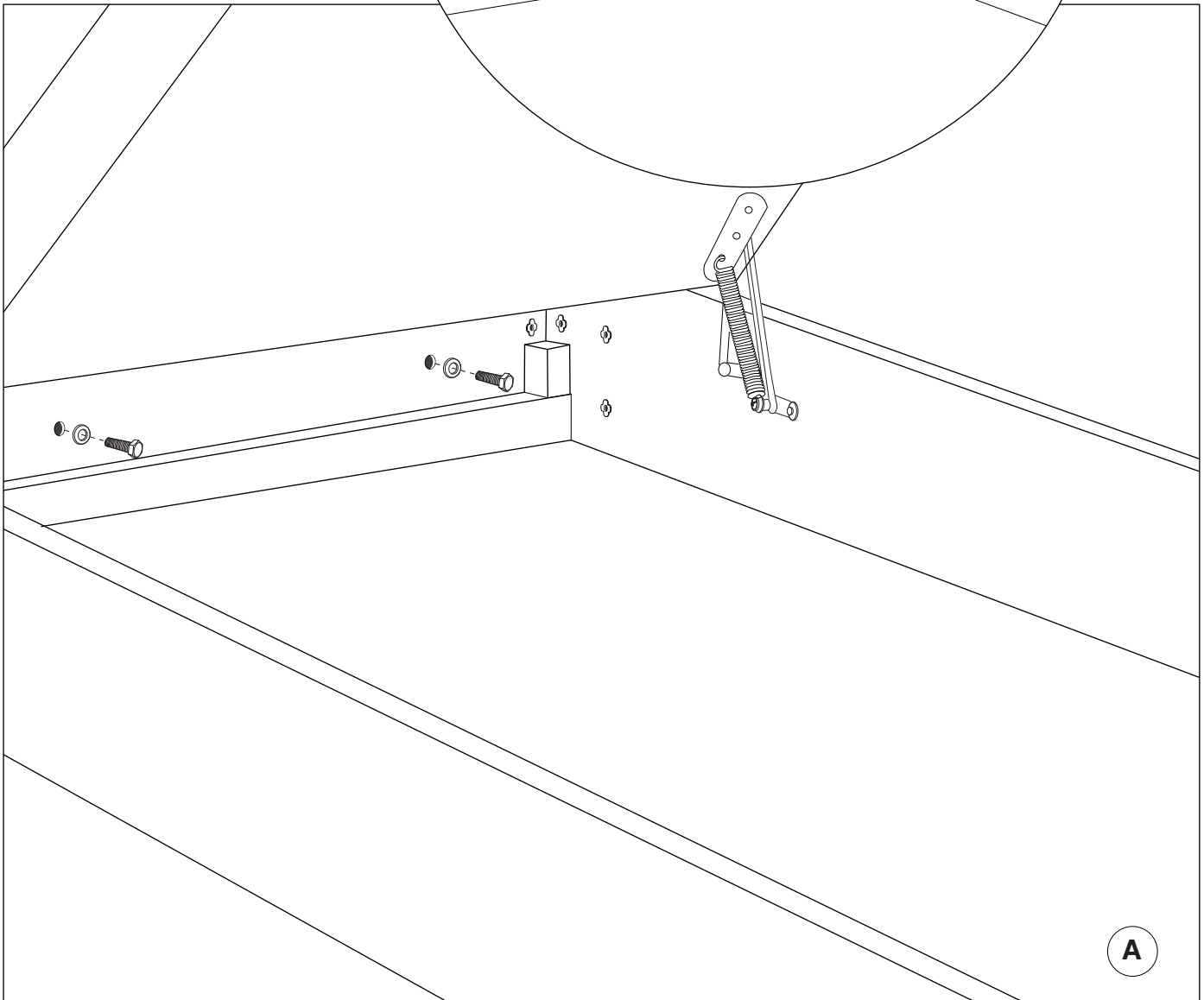
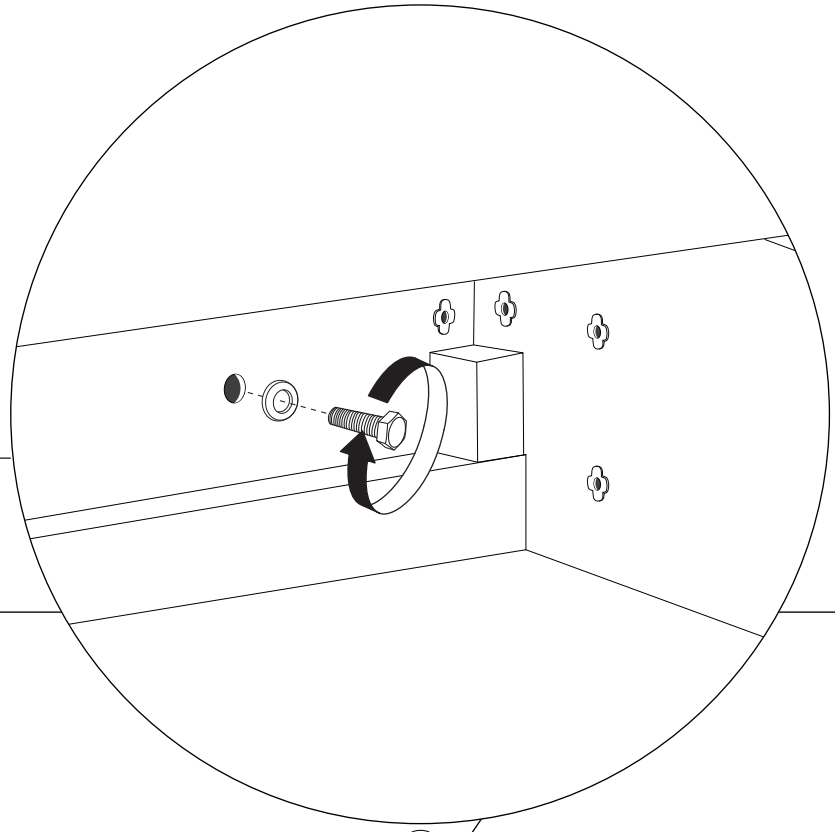

A

3

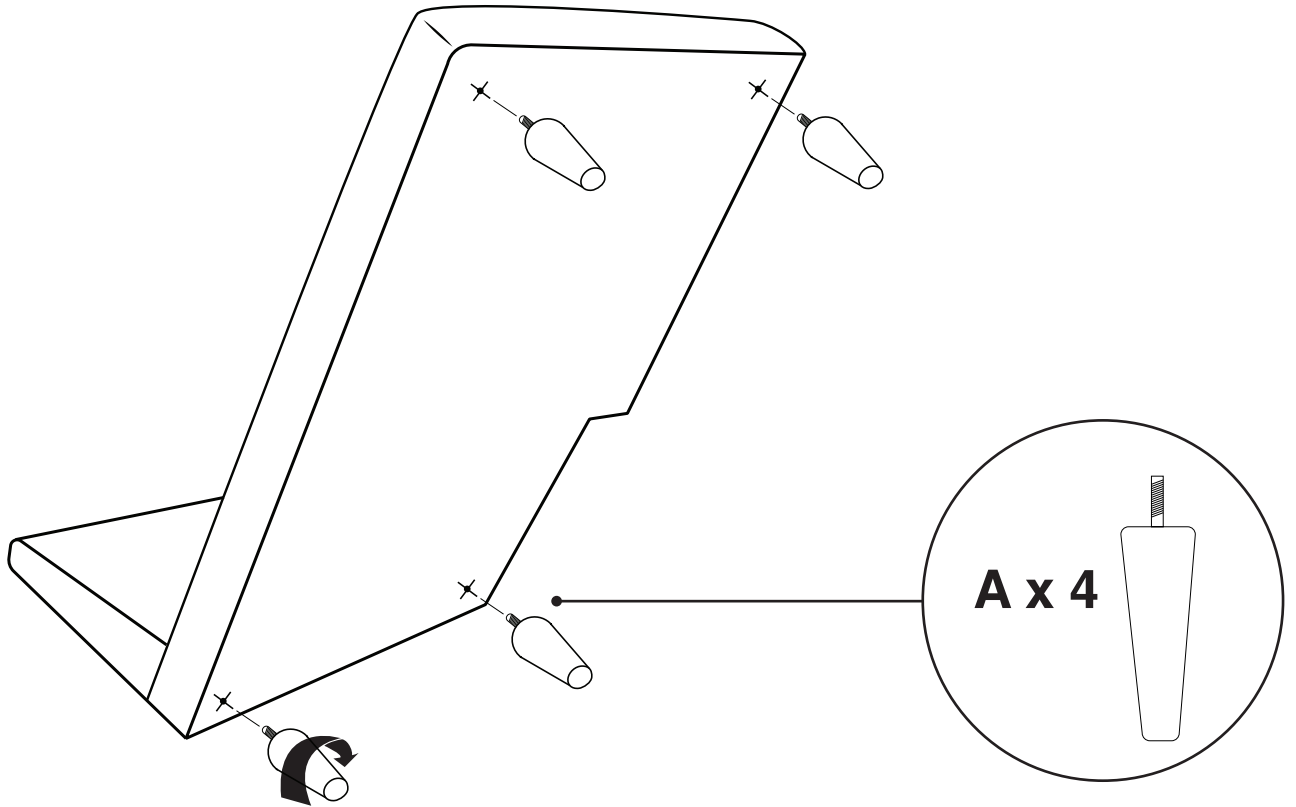

4

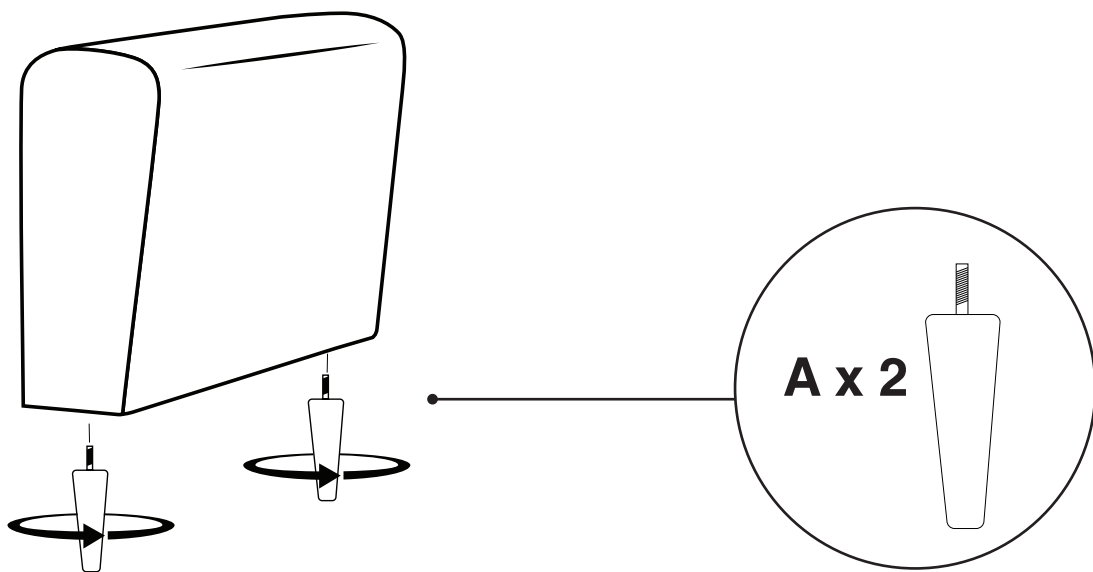

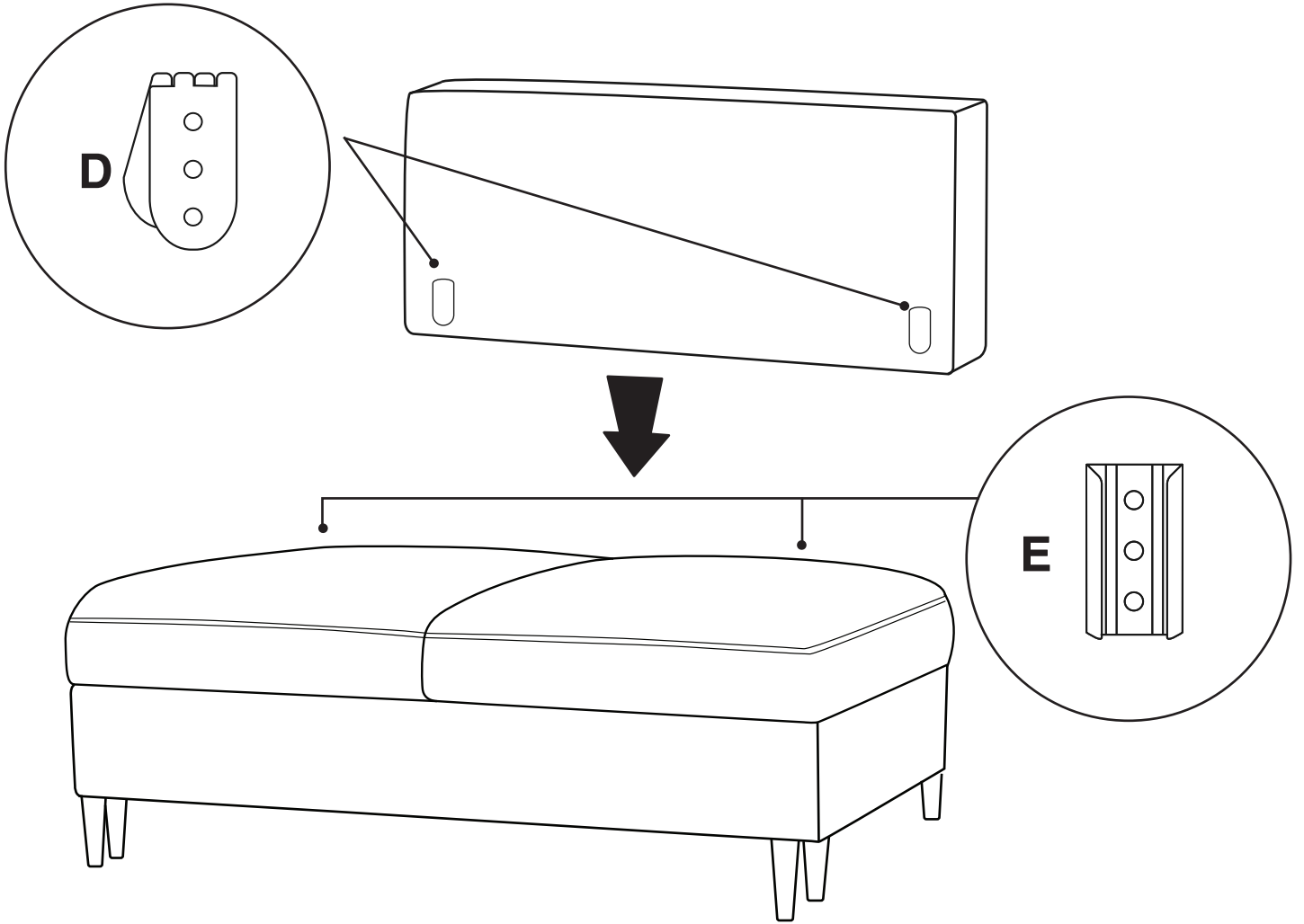

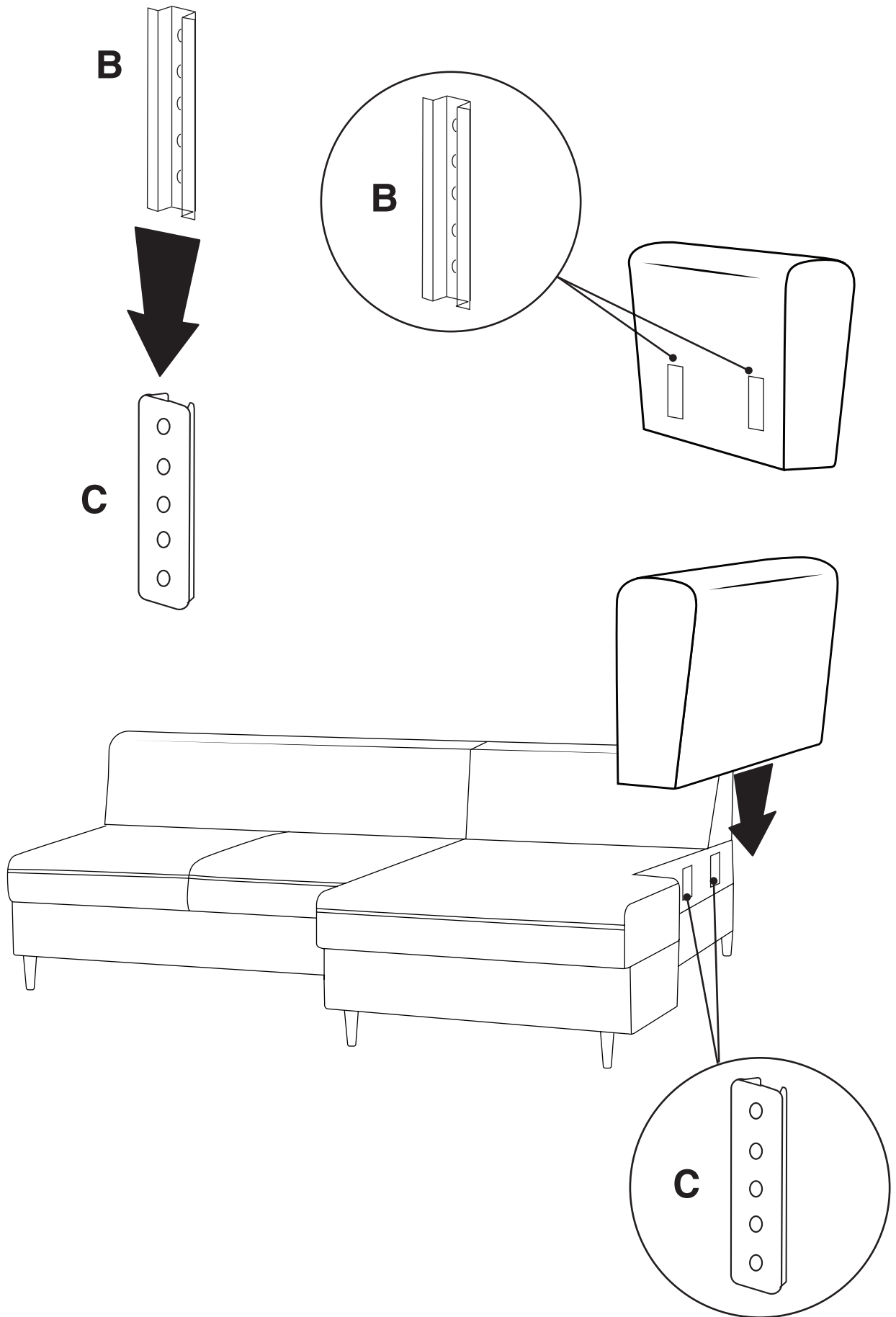

7

Moghan
sofa

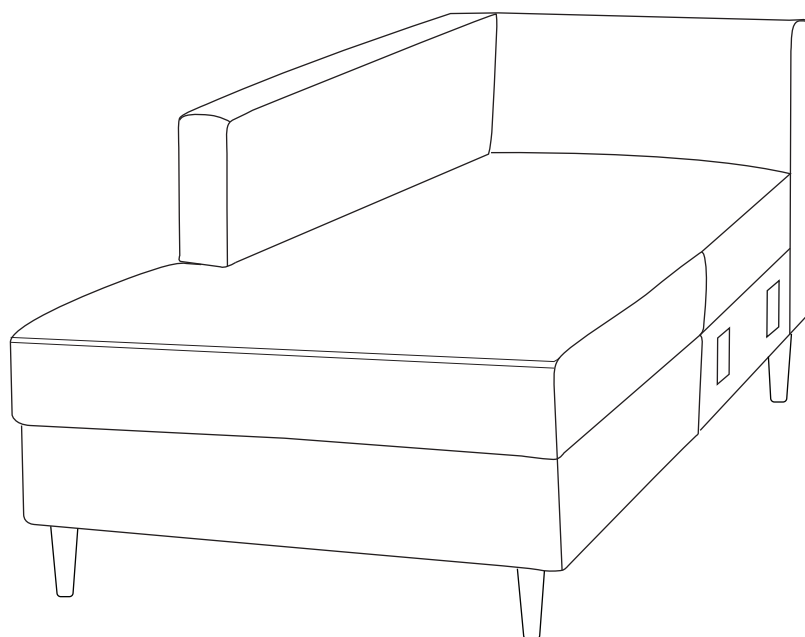
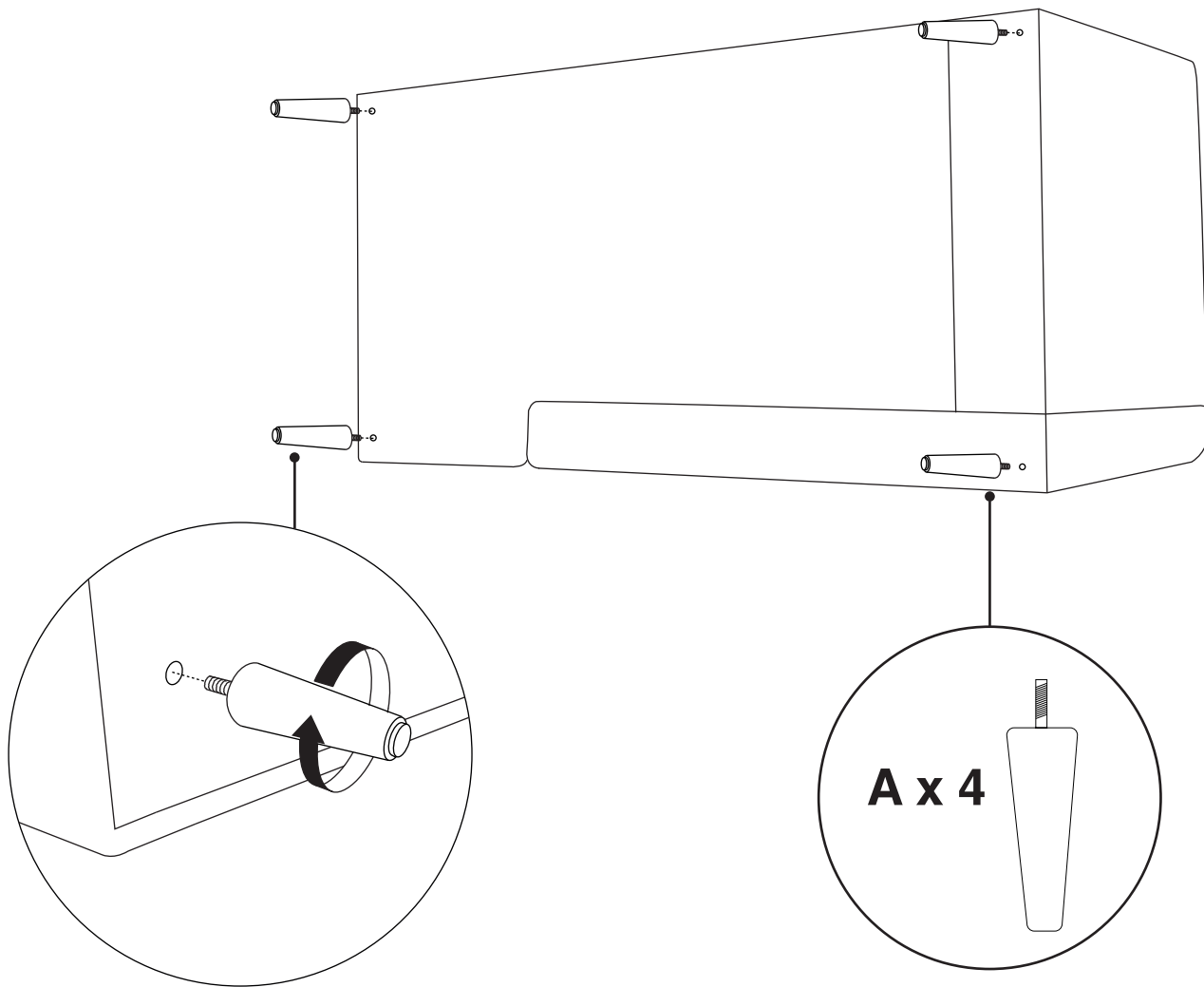

8

Moghan
sofa

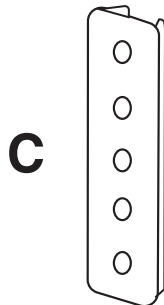
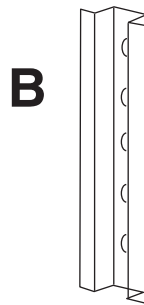
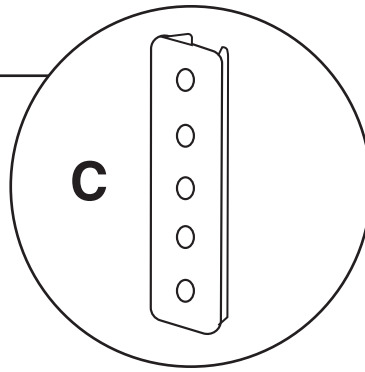
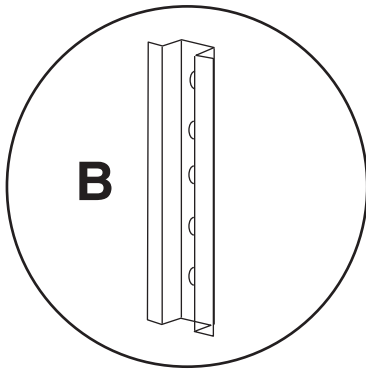
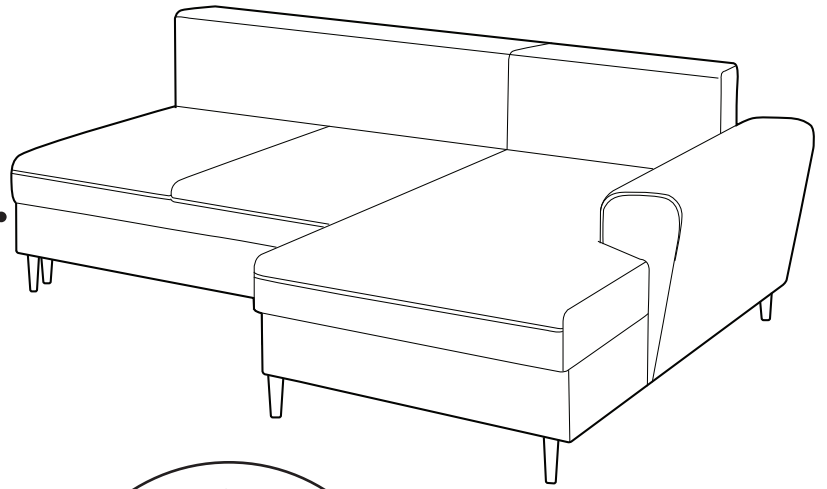
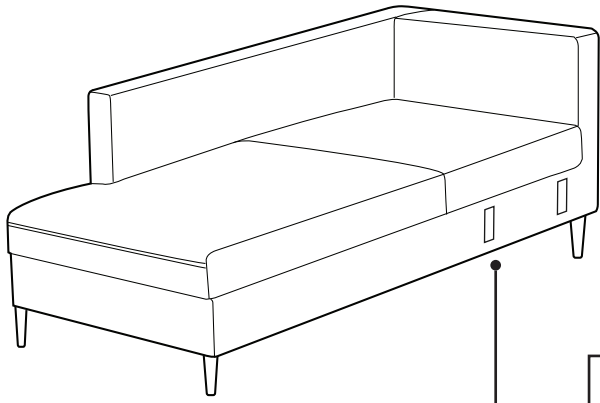

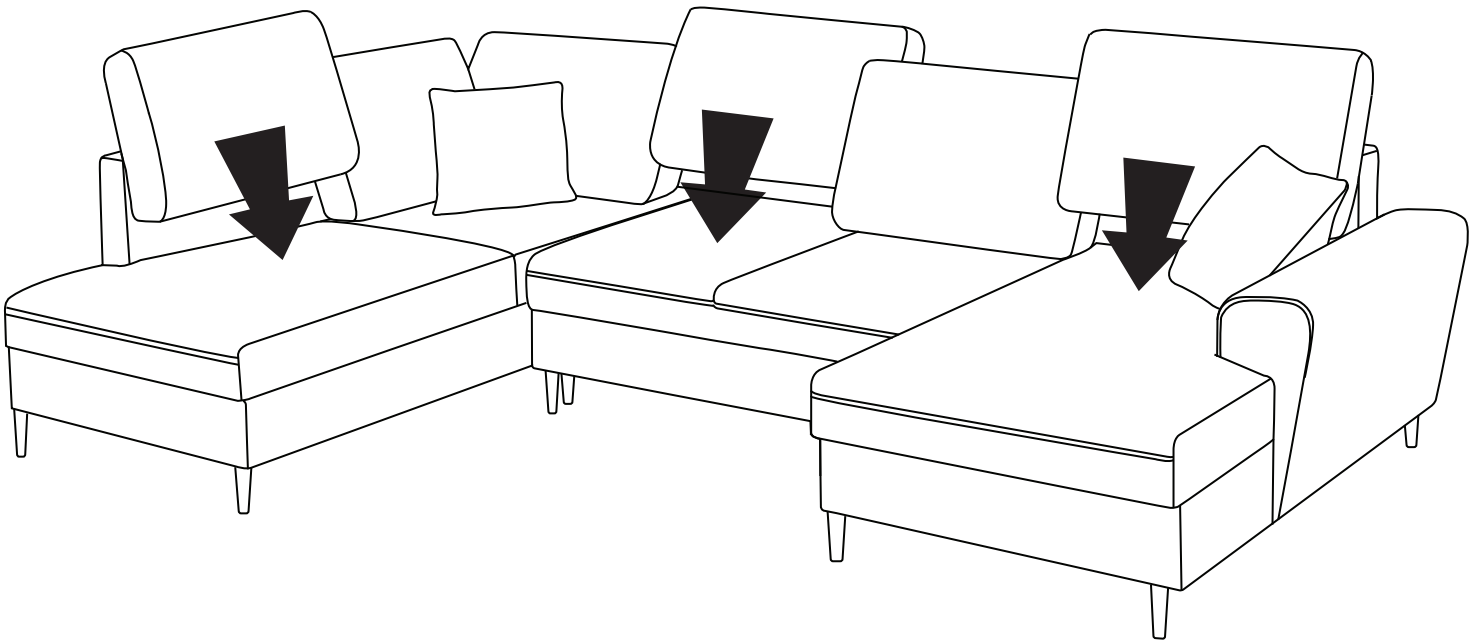
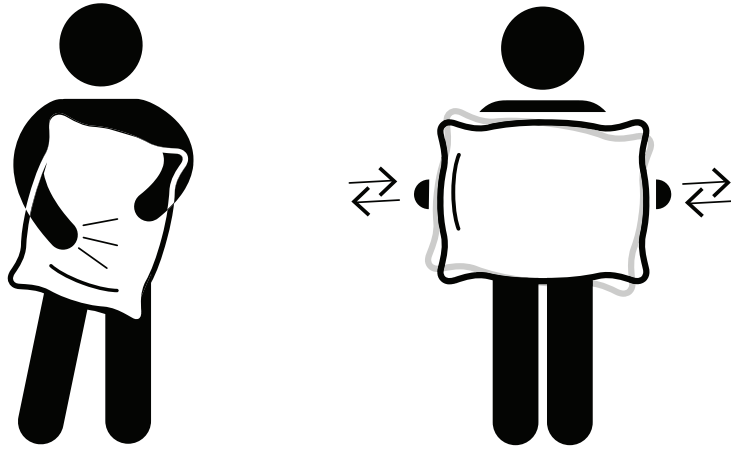

SHAPE UP ALL PILLOWS AND CUSHIONS!

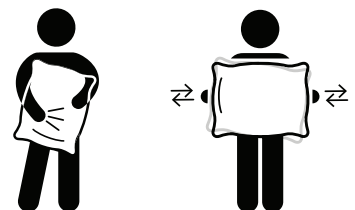

bed function

1.

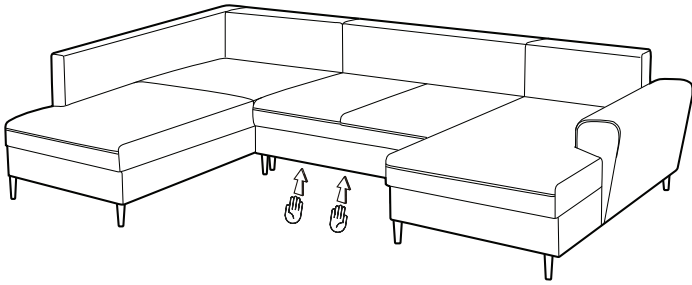

3.

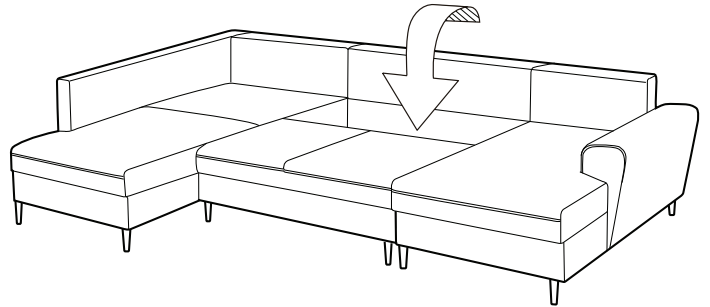

2.

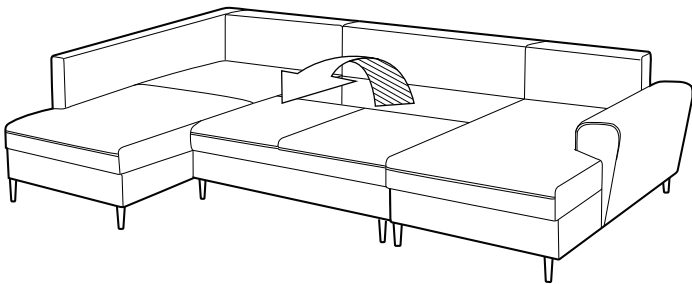

4.

