

Haidi

sofa 3s

A



x2

B



x4

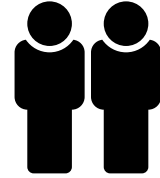

1

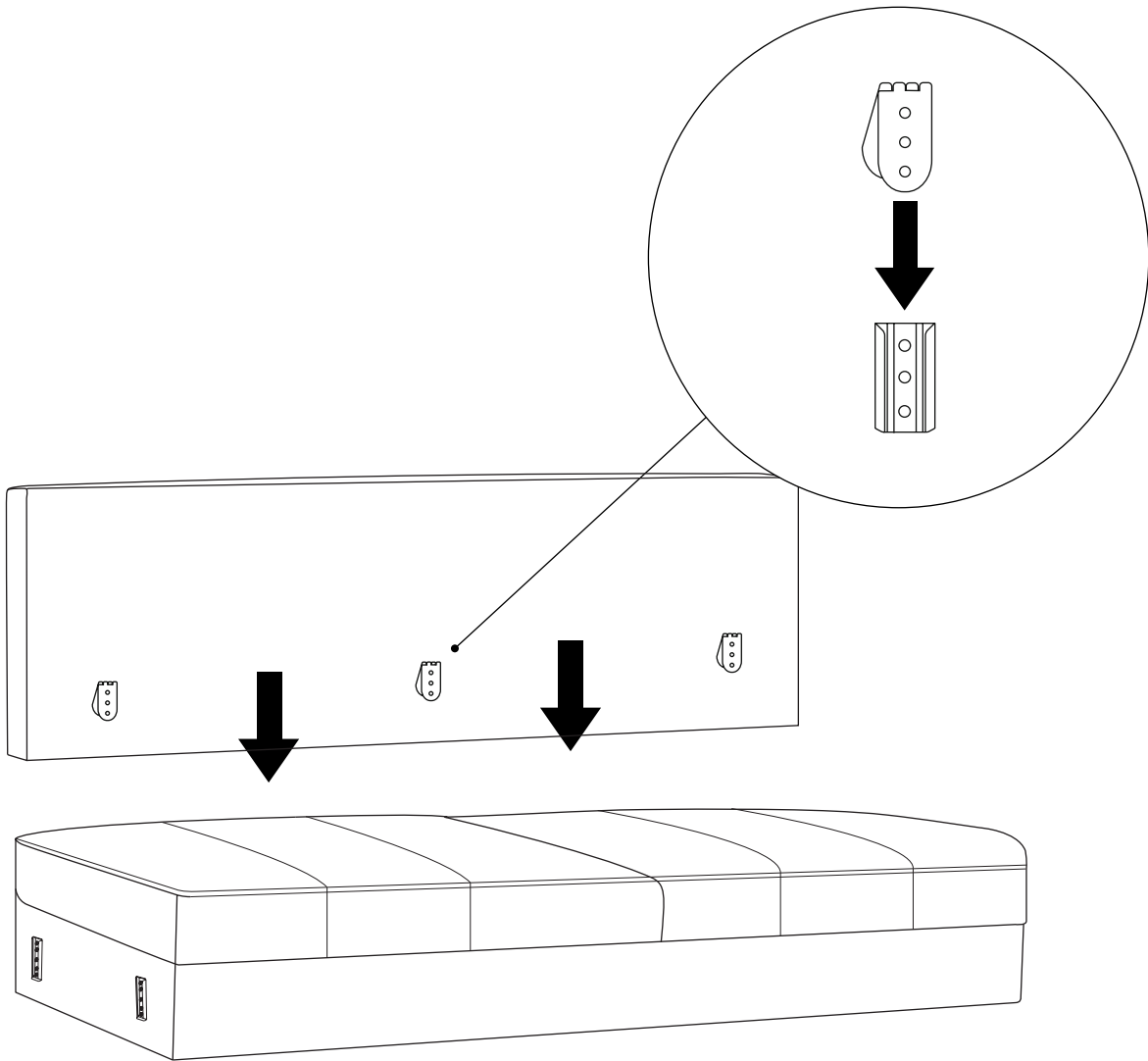

2

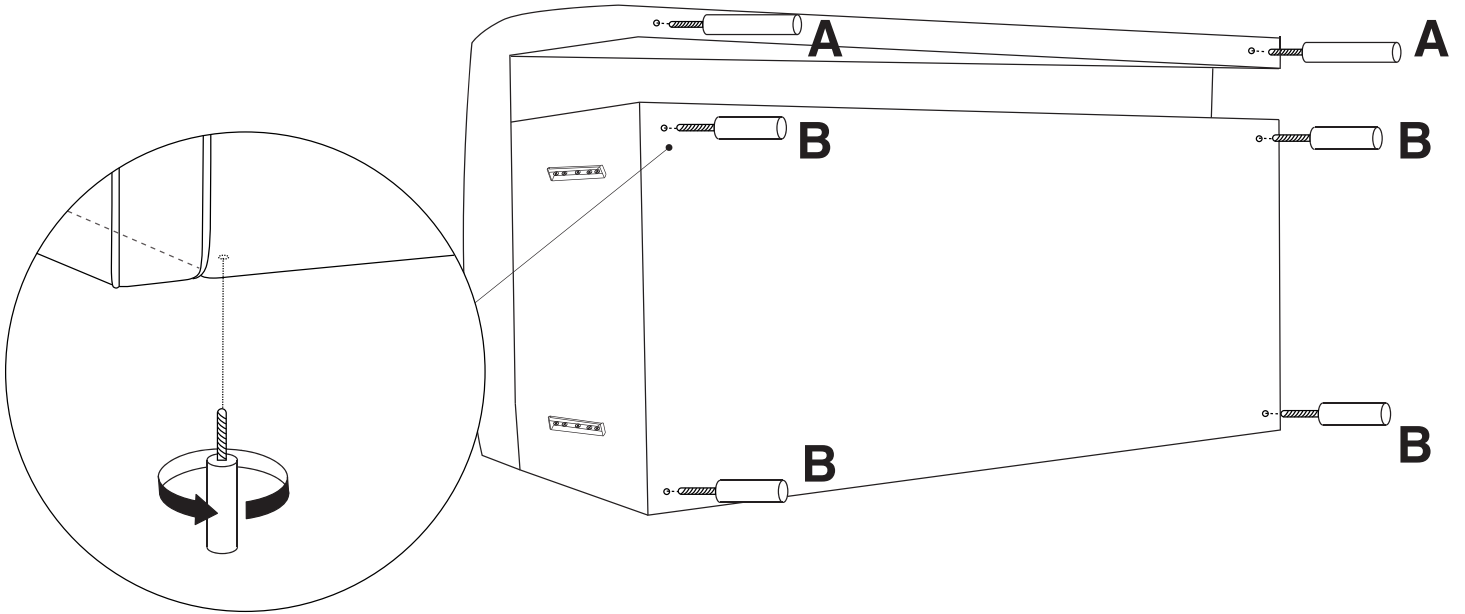

3

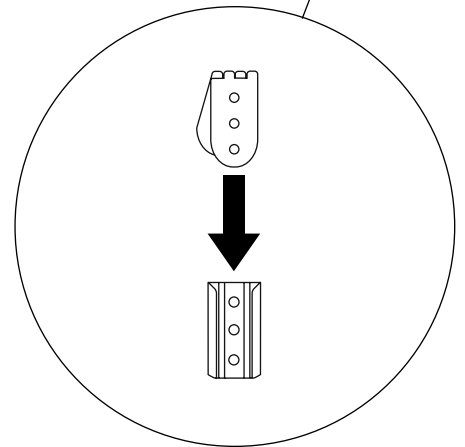
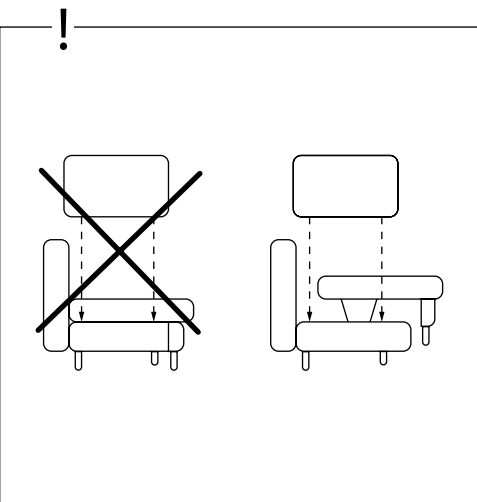
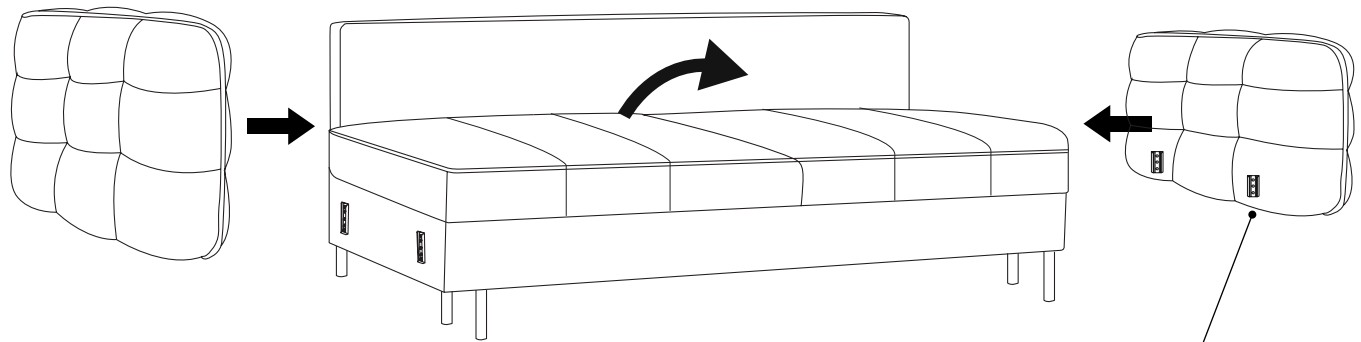

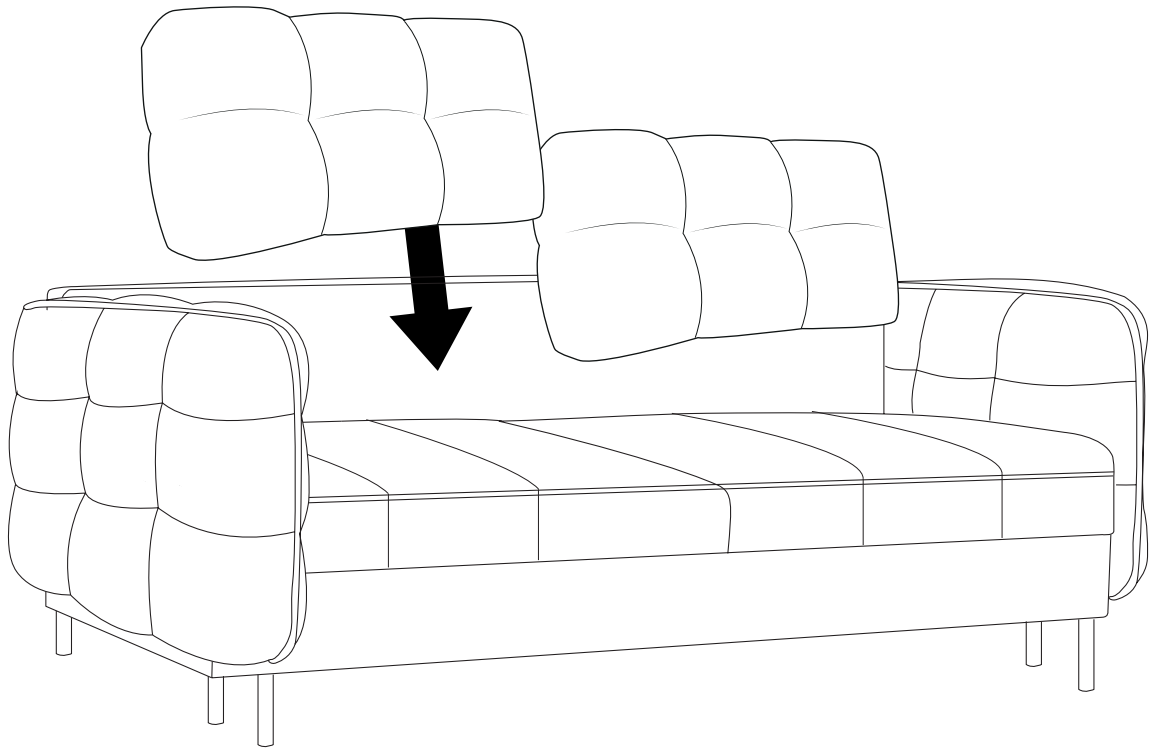

3 of 4

SHAPE UP ALL PILLOWS AND CUSHIONS!

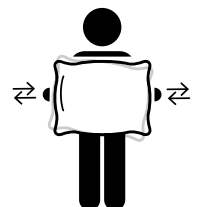

bed function

