

Caro

sofa 3s

A



x2

B

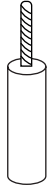

x4

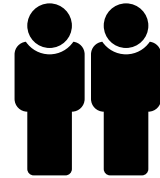

1

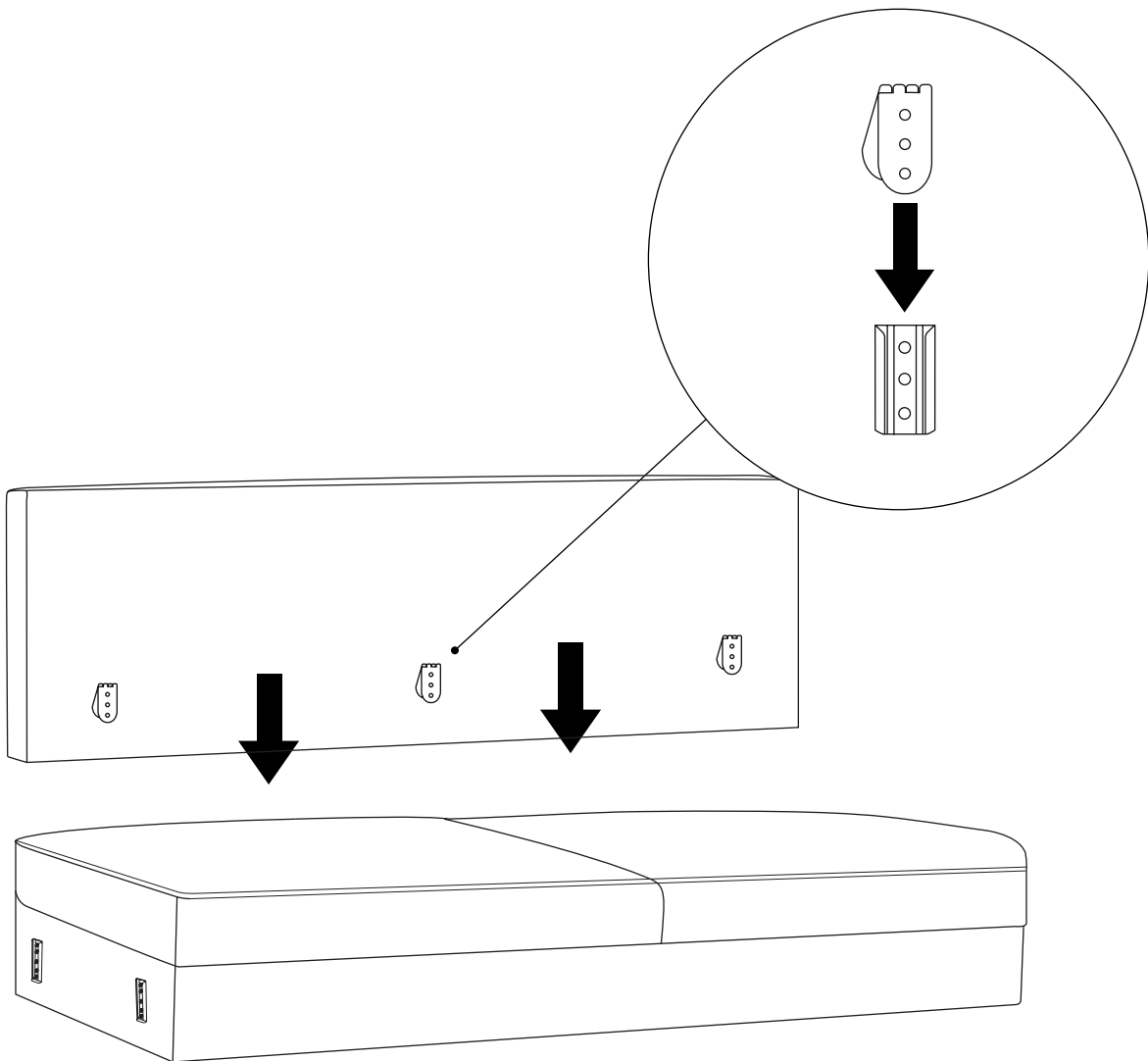

2

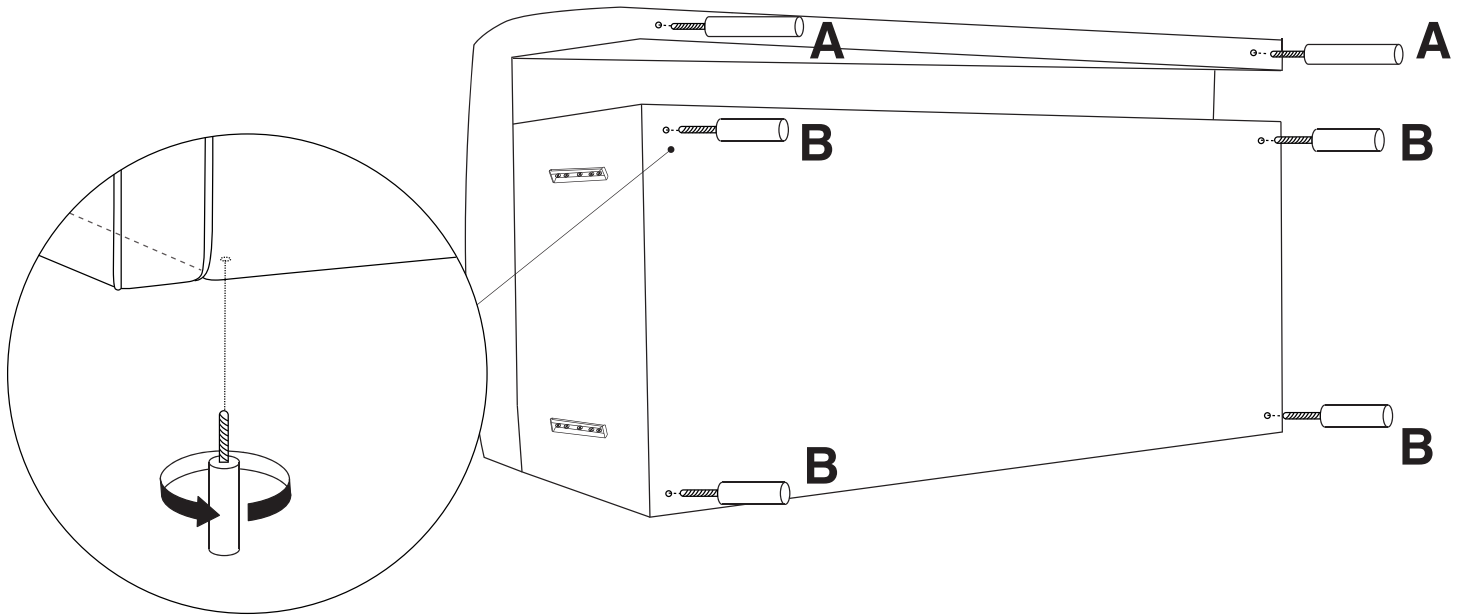

3

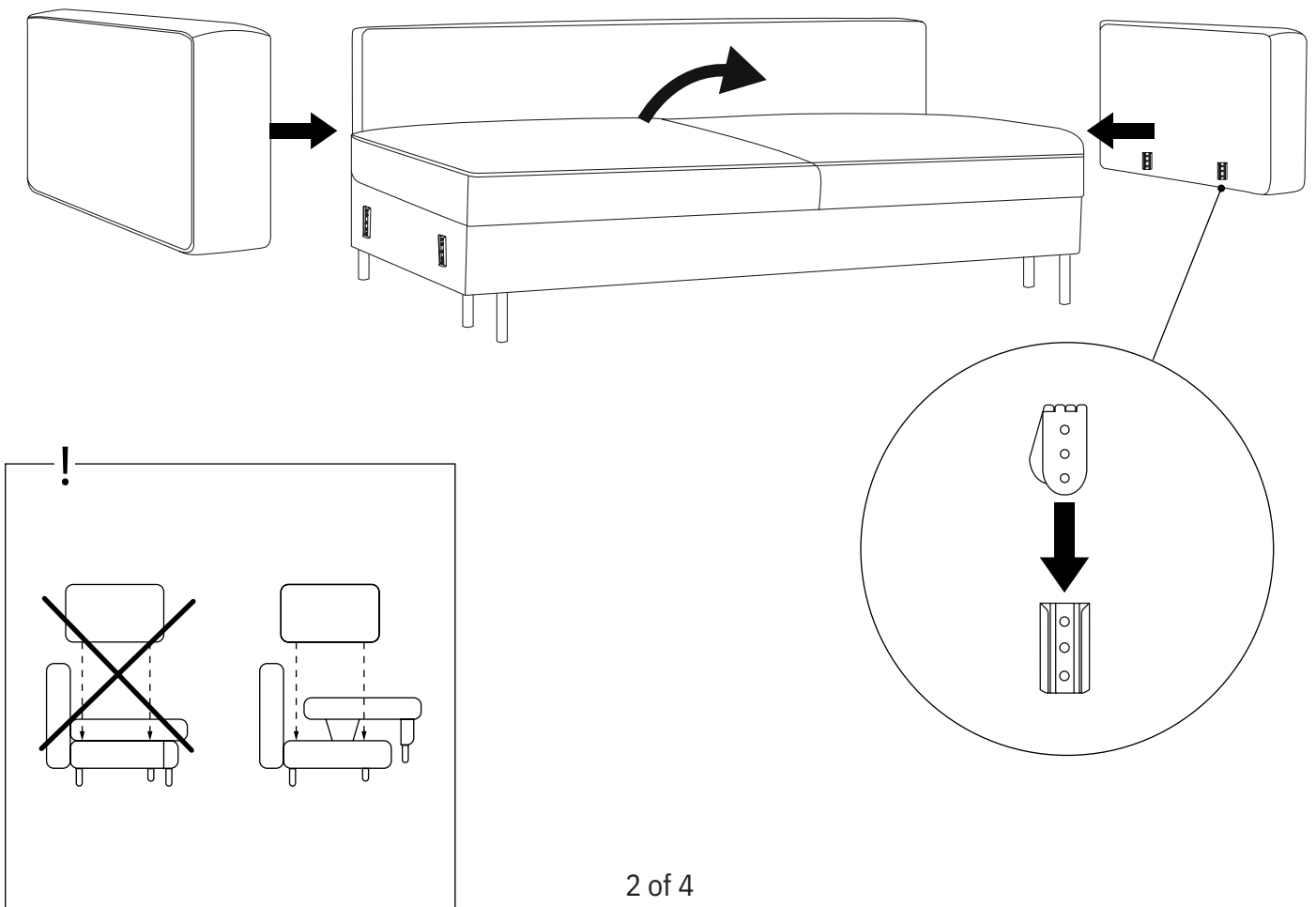

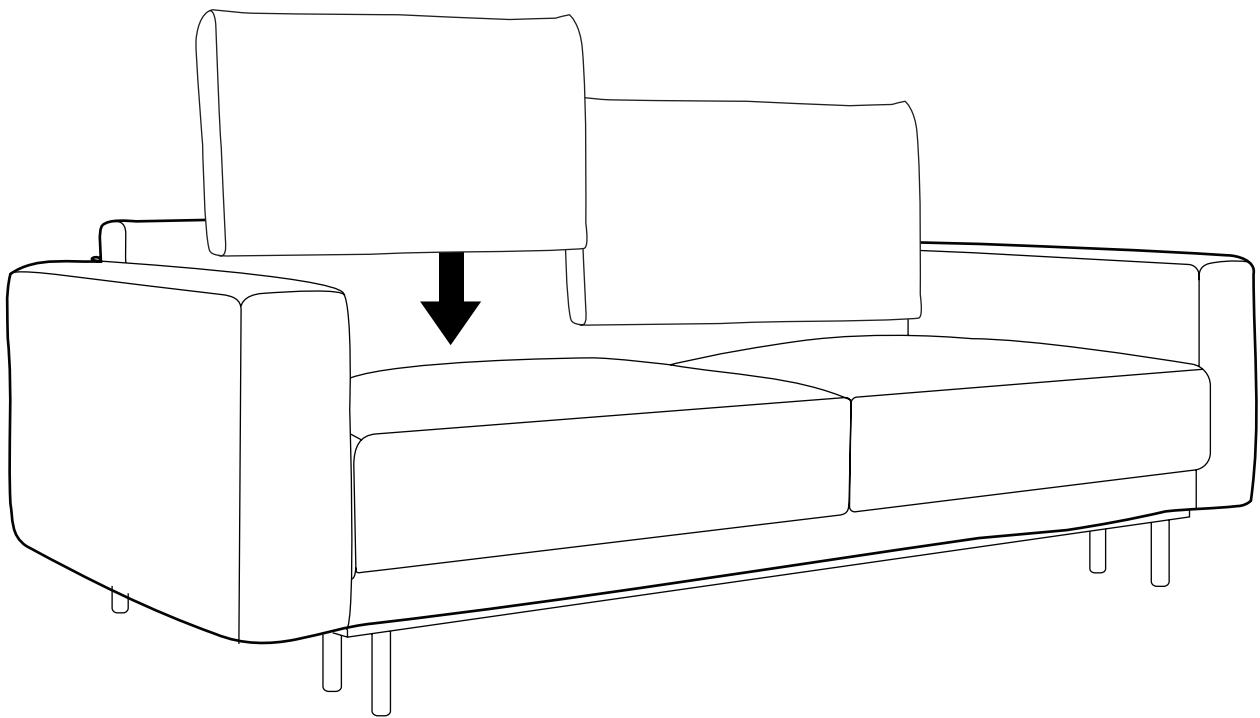

3 of 4

SHAPE UP ALL PILLOWS AND CUSHIONS!

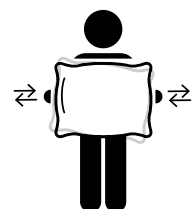

bed function

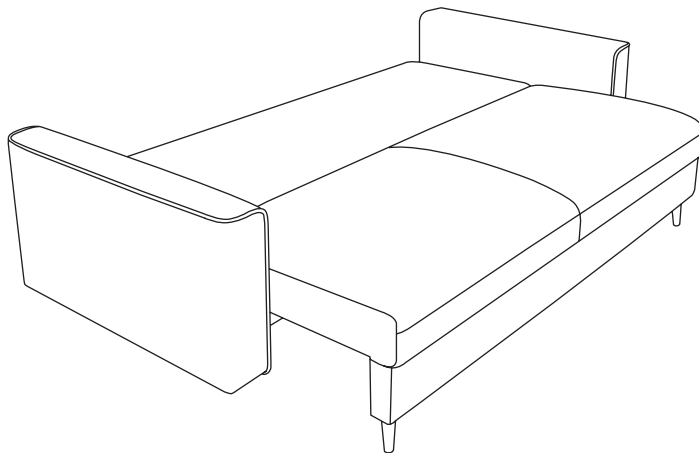
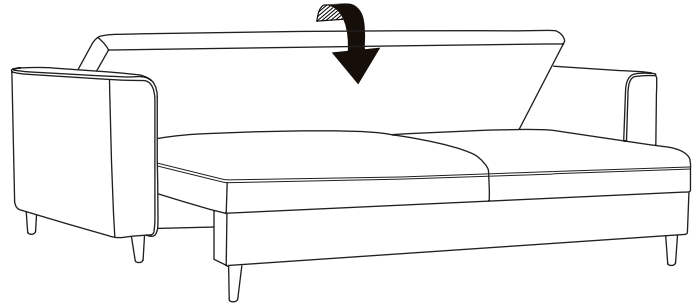
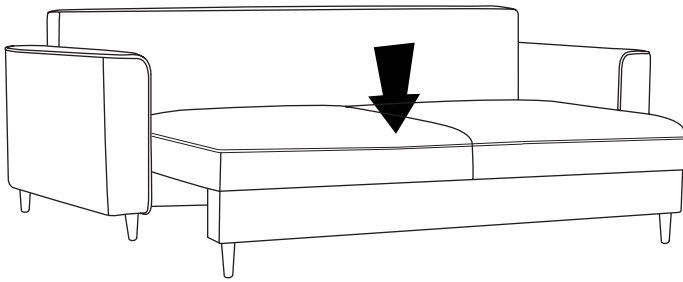
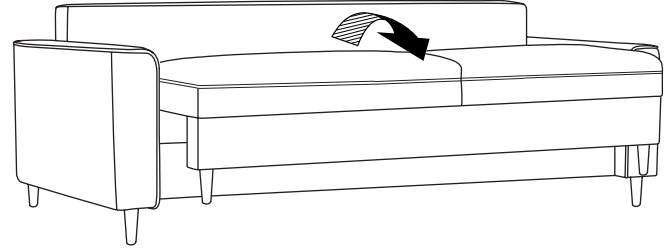
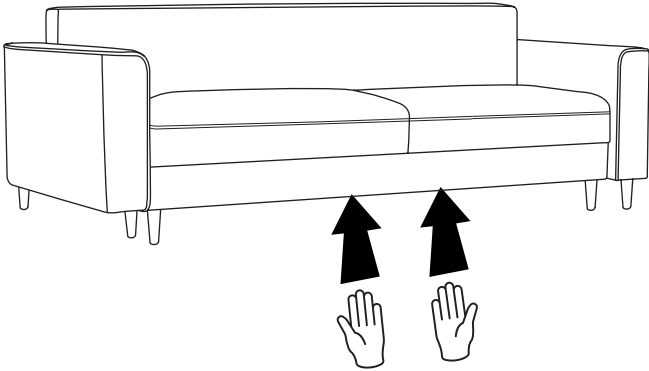

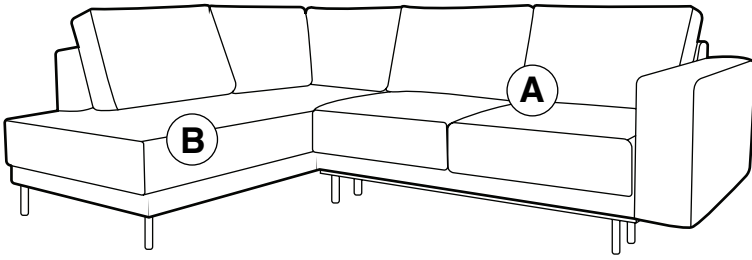

Caro

corner sofa

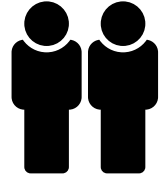
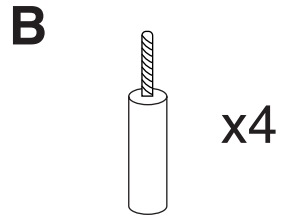
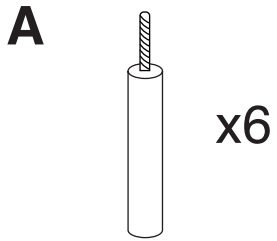

1

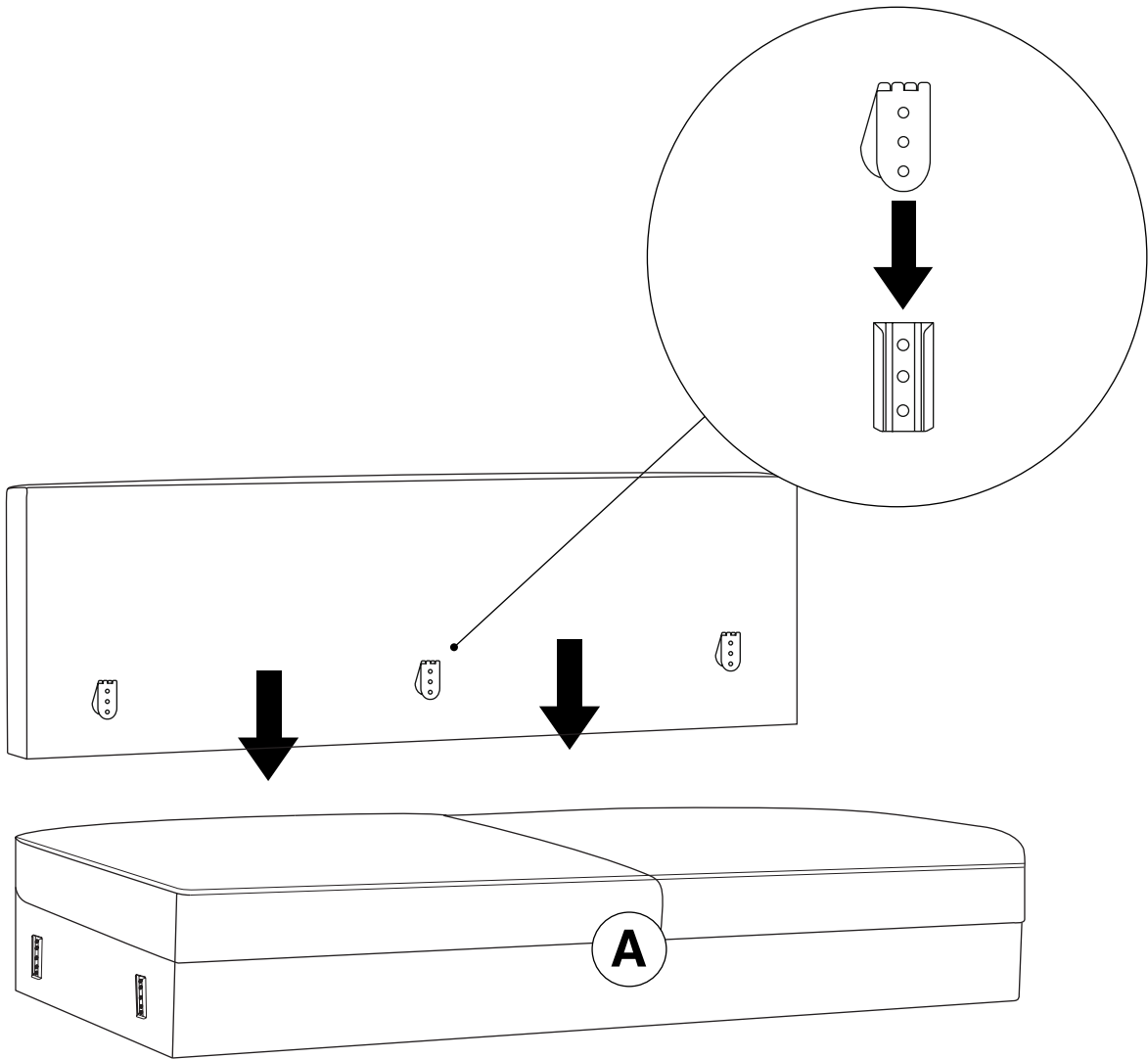

2

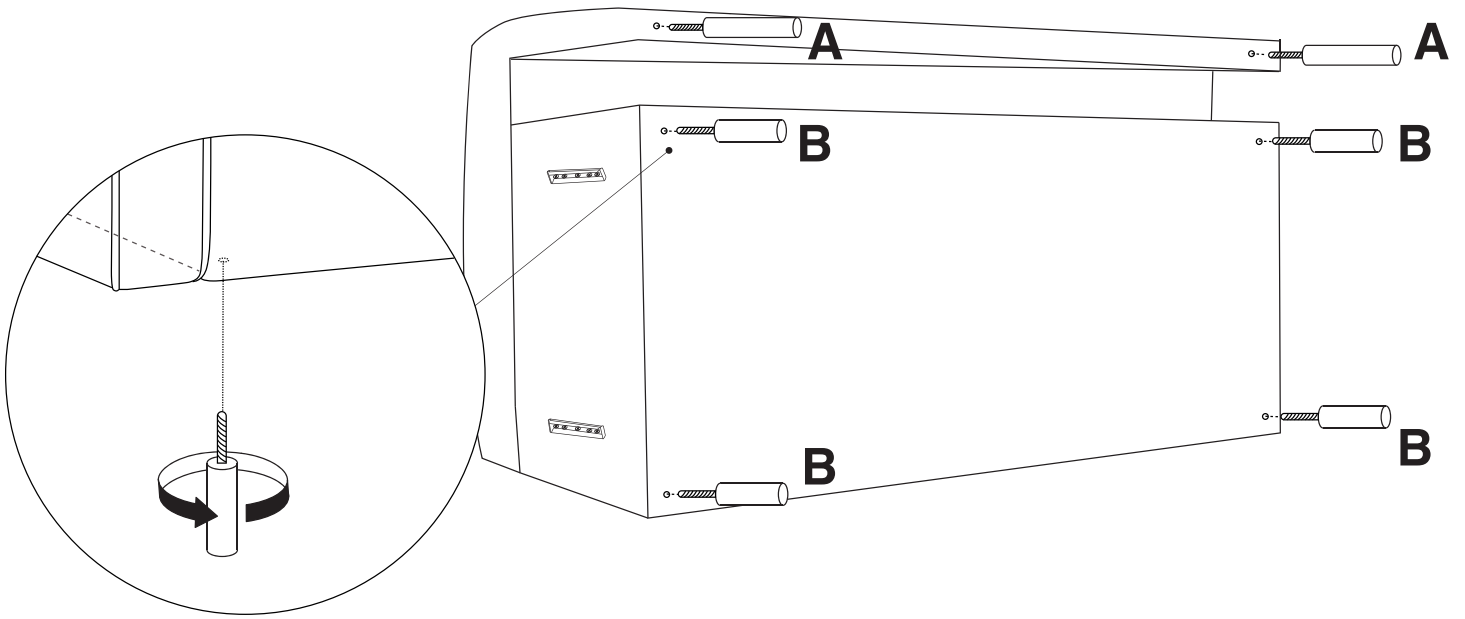

3

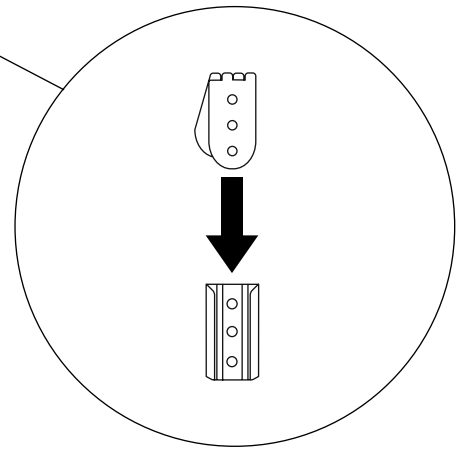
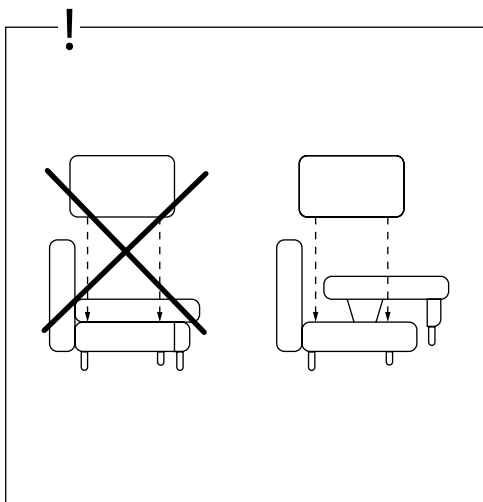
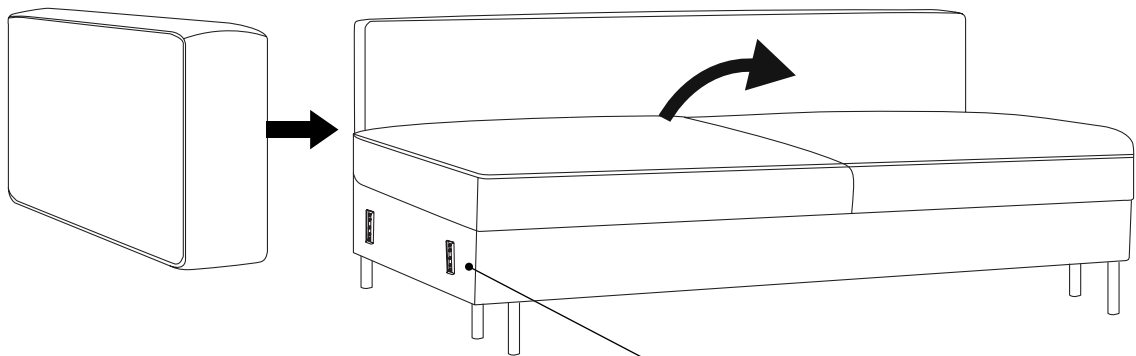

4

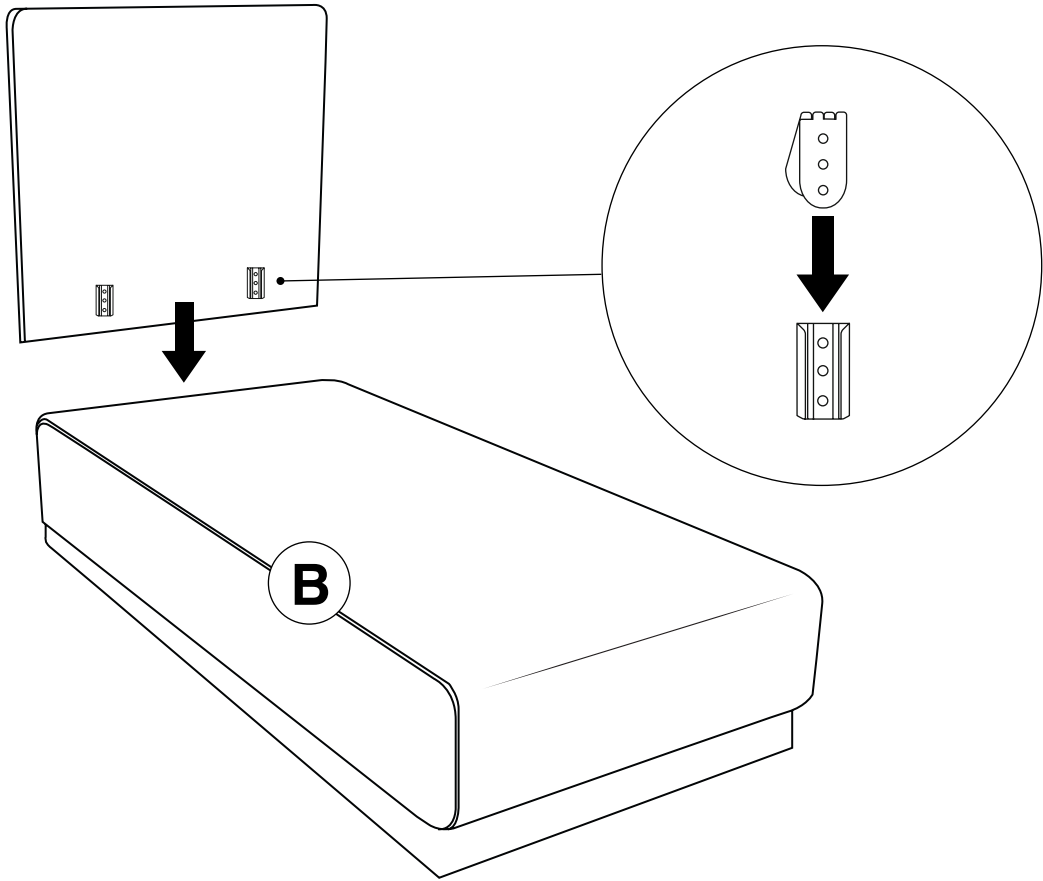

5

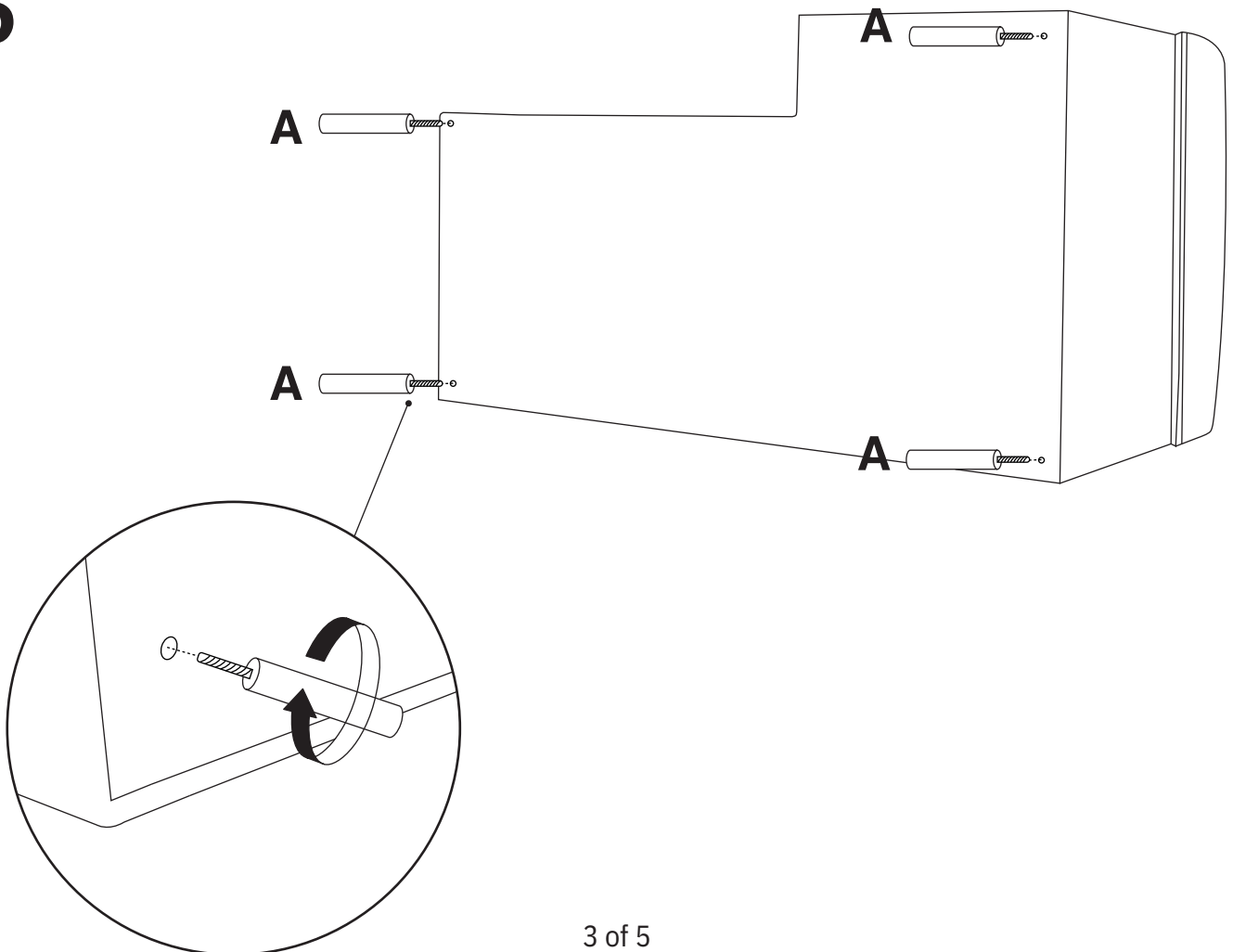

6

Caro
corner sofa

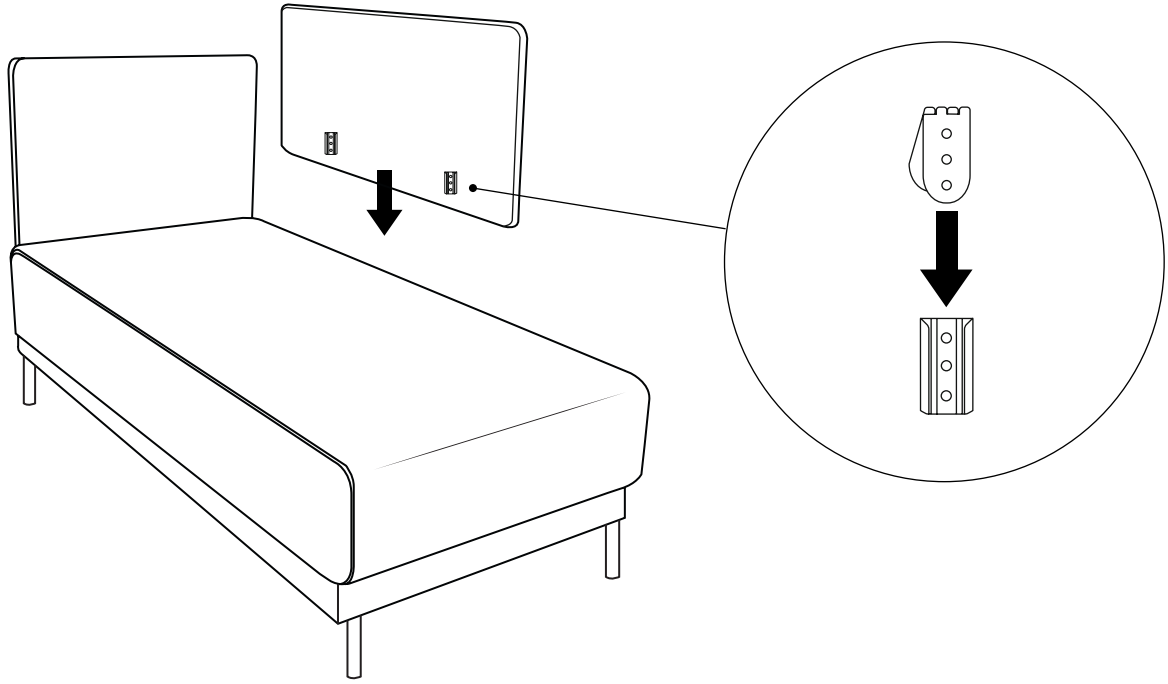

7

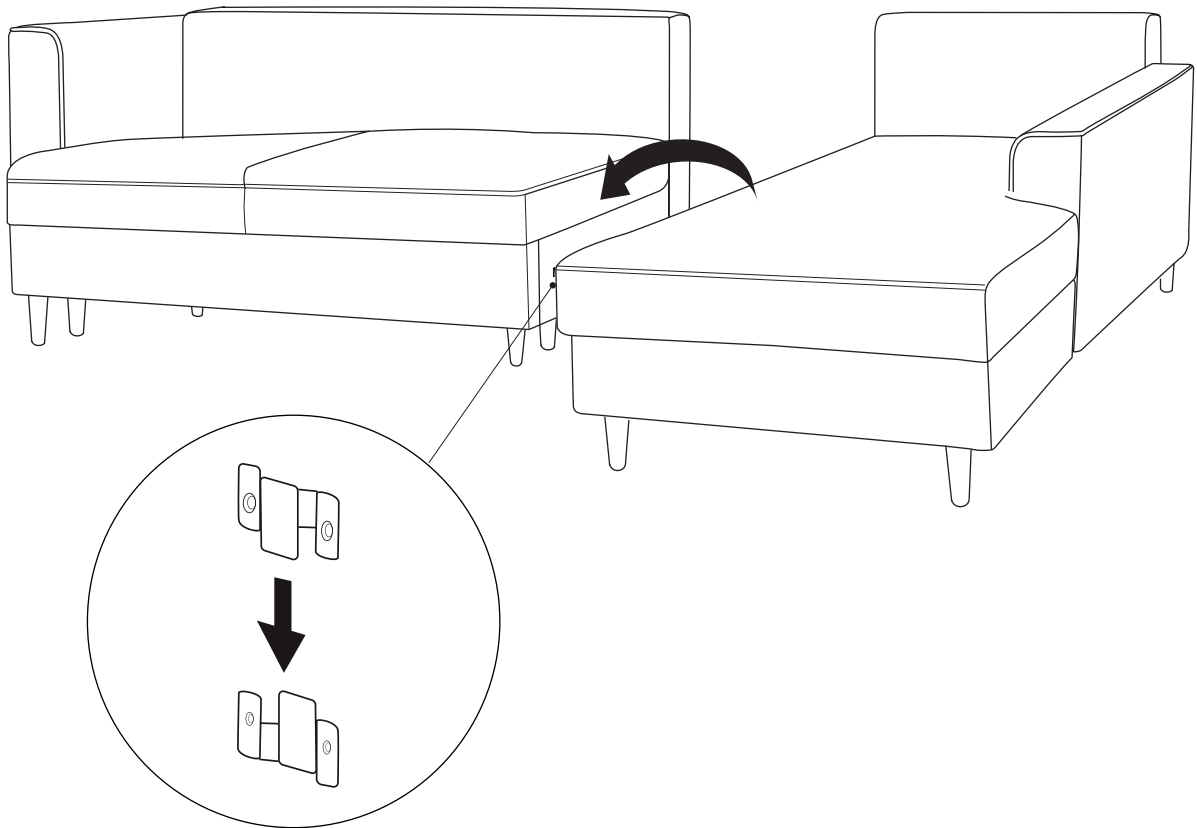

4 of 5

SHAPE UP ALL PILLOWS AND CUSHIONS!

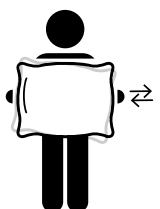

bed function

