

IMPORTANTE - TENERE PER FUTURE CONSULTAZIONI: LEGGERE ATTENTAMENTE

IMPORTANT - RETAIN FOR FUTURE REFERENCE: READ CAREFULLY

IMPORTANTE - ARCHIVAR LAS INSTRUCCIONES PARA CONSULTARLAS MÁS TARDE: LEA ATENTAMENTE

IMPORTANT - À CONSERVER POUR CONSULTATION ULTERIEURE: LIRE ATTENTIVEMENT

WICHTIG - FÜR ZUKUNFT REFERENZ AUFBEWAHREN: BITTE ES SORGFÄLTIG ZU LESEN



3 minutes



INCLUSI
INCLUDED
INCLUIDOS
INCLUS
INBEGRIFFEN

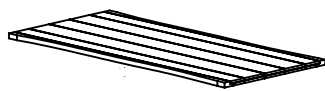

A x 1



B x 2



C x 8



D x 8



E x 1

IT

PRIMA DI PROCEDERE CON IL MONTAGGIO, ASSICURARSI DI POSIZIONARE IL PRODOTTO SU UNA SUPERFICIE PIANA E PULITA E UTILIZZARE UN TELO MORBIDO D'APPOGGIO DURANTE L'ASSEMBLAGGIO. QUESTO PER EVITARE URTI E DANNI AL PRODOTTO DURANTE IL MONTAGGIO.

EN

BEFORE PROCEEDING WITH THE ASSEMBLY, MAKE SURE TO PLACE THE PRODUCT ON A FLAT AND CLEAN SURFACE AND USE A SOFT COVER DURING ASSEMBLY TO AVOID IMPACTS AND DAMAGE TO THE PRODUCT.

ES

ANTES DEL MONTAJE, ASEGÚRESE DE COLOCAR EL PRODUCTO SOBRE UNA SUPERFICIE LIMPIA Y PLANA Y USE UNA TELA SUAVE COMO SOPORTE PARA EVITAR GOLPES Y DAÑOS AL PRODUCTO DURANTE EL MONTAJE.

FR

AVANT DE PROCÉDER À L'ASSEMBLAGE, ASSUREZ-VOUS DE PLACER LE PRODUIT SUR UNE SURFACE PLANE ET PROPRE ET D'UTILISER UN TISSU SOUPLE DE SUPPORT POUR ÉVITER DES COUPS ET DES DOMMAGES AU PRODUIT PENDANT L'ASSEMBLAGE.

DE

VOR DEM AUFBAU BITTE DAS PRODUKT AUF EINE EBENE UND SAUBERE FLÄCHE STELLEN UND ES EMPFIEHLT SICH, DAS PRODUKT AUF EINE WEICHE DECKE AUFZUBAUEN. SO WIRD VERHINDERT, DASS BEIM AUFBAU BESCHÄDIGUNGEN UND BEULEN AM PRODUKT ENTSTEHEN.

1

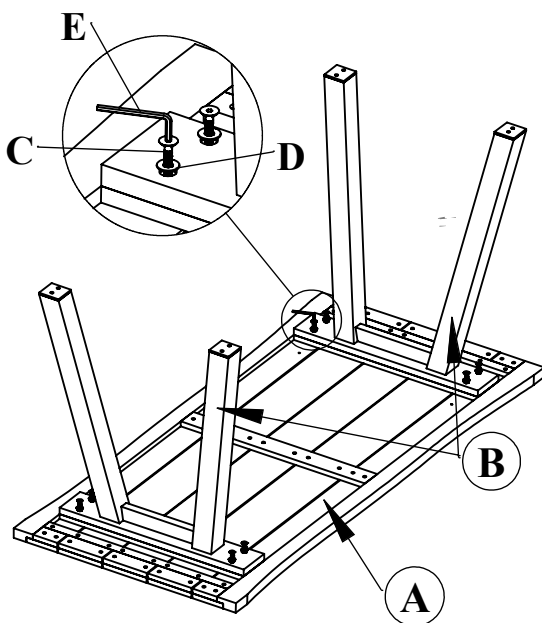

2

