

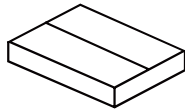

5 min



x1



x1

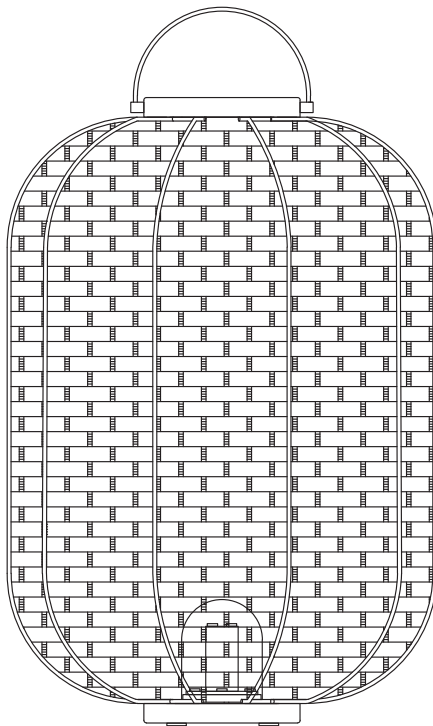

A x 1

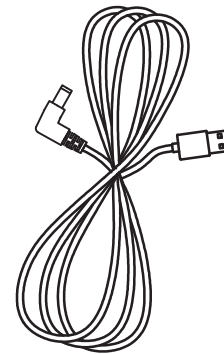

B x 1

1

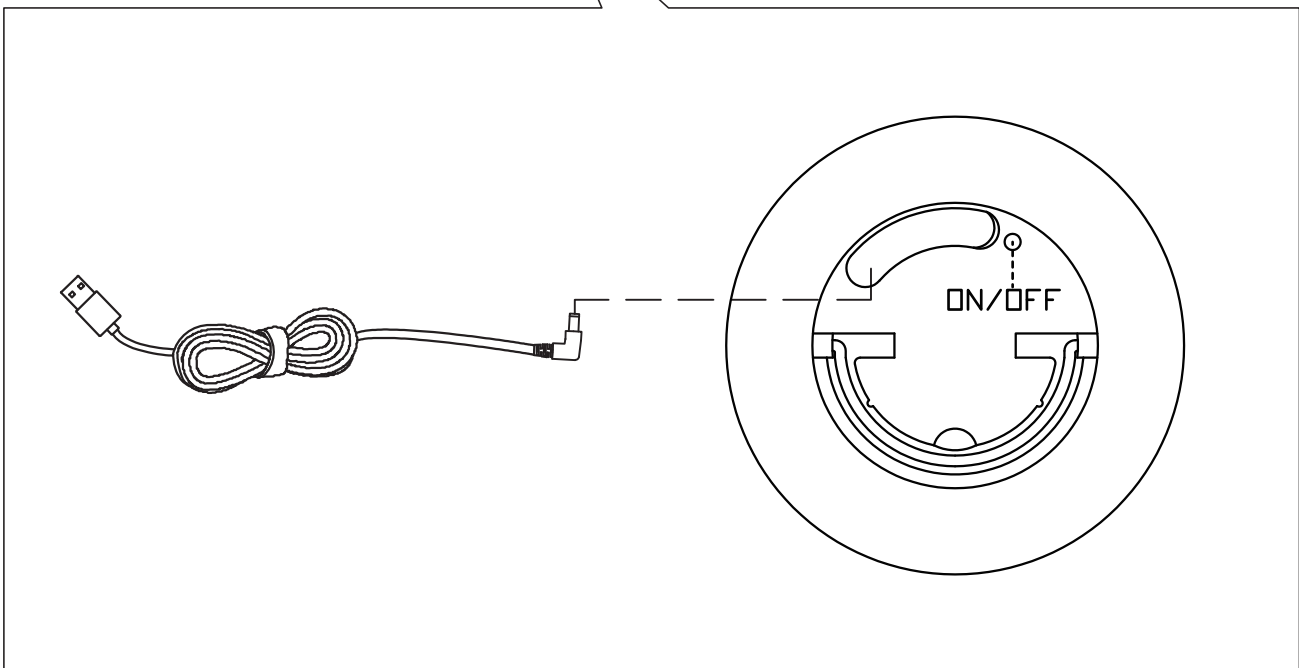
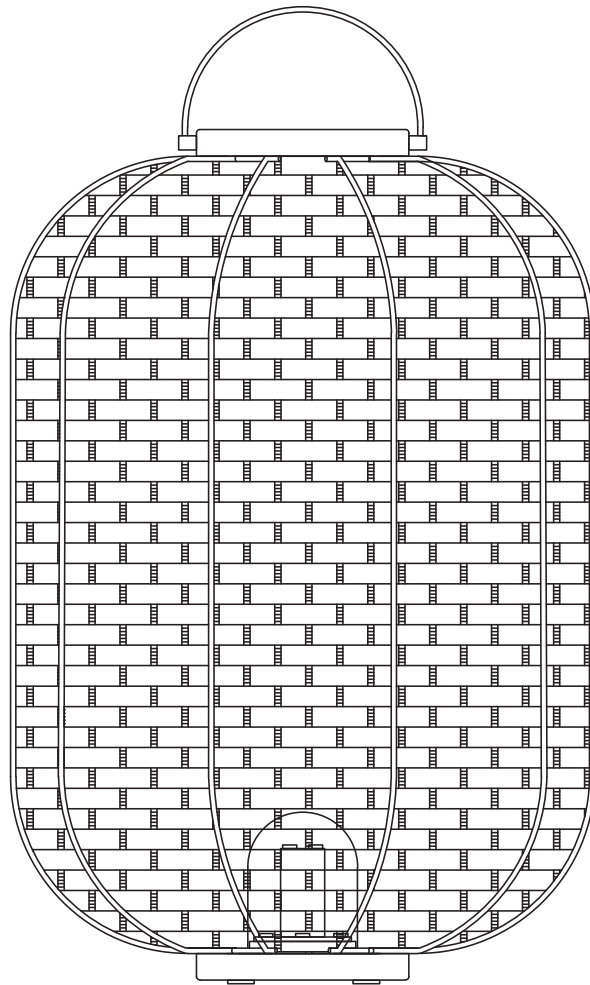



2

i





1" → ON



ON + 1" →  10 LUMEN

ON + 1" →  50 LUMEN

ON + 1" →  75 LUMEN



1" → OFF

3

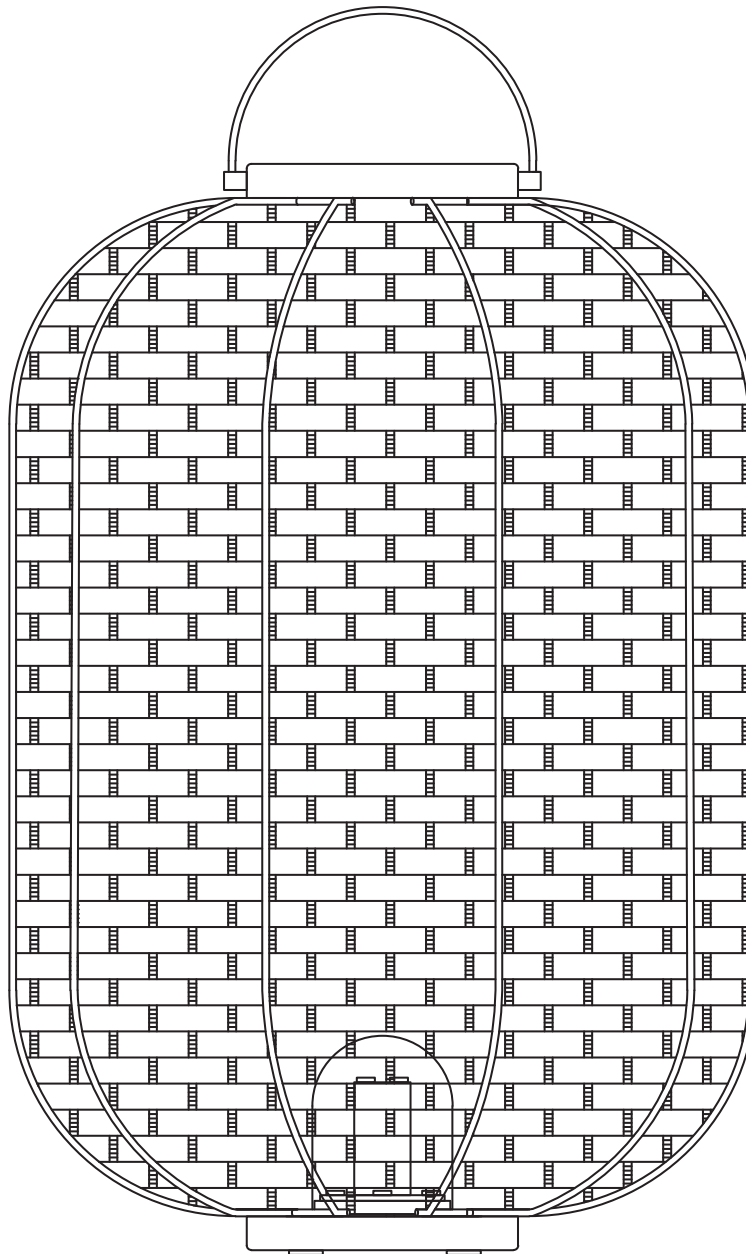

THAT'S ALL FOLKS!

Share your style!

#KaveHome

