 5 min	 X1	 X2
--	---	---

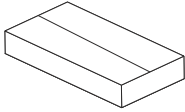

A x1

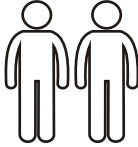

B x1

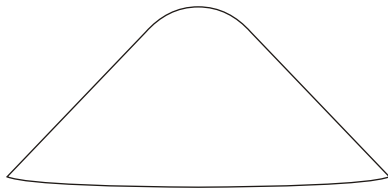
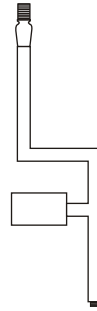

C x1

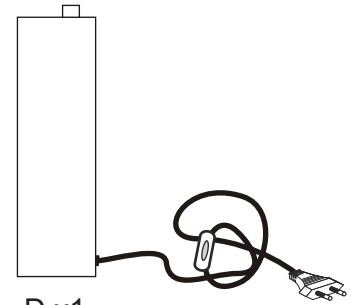

D x1

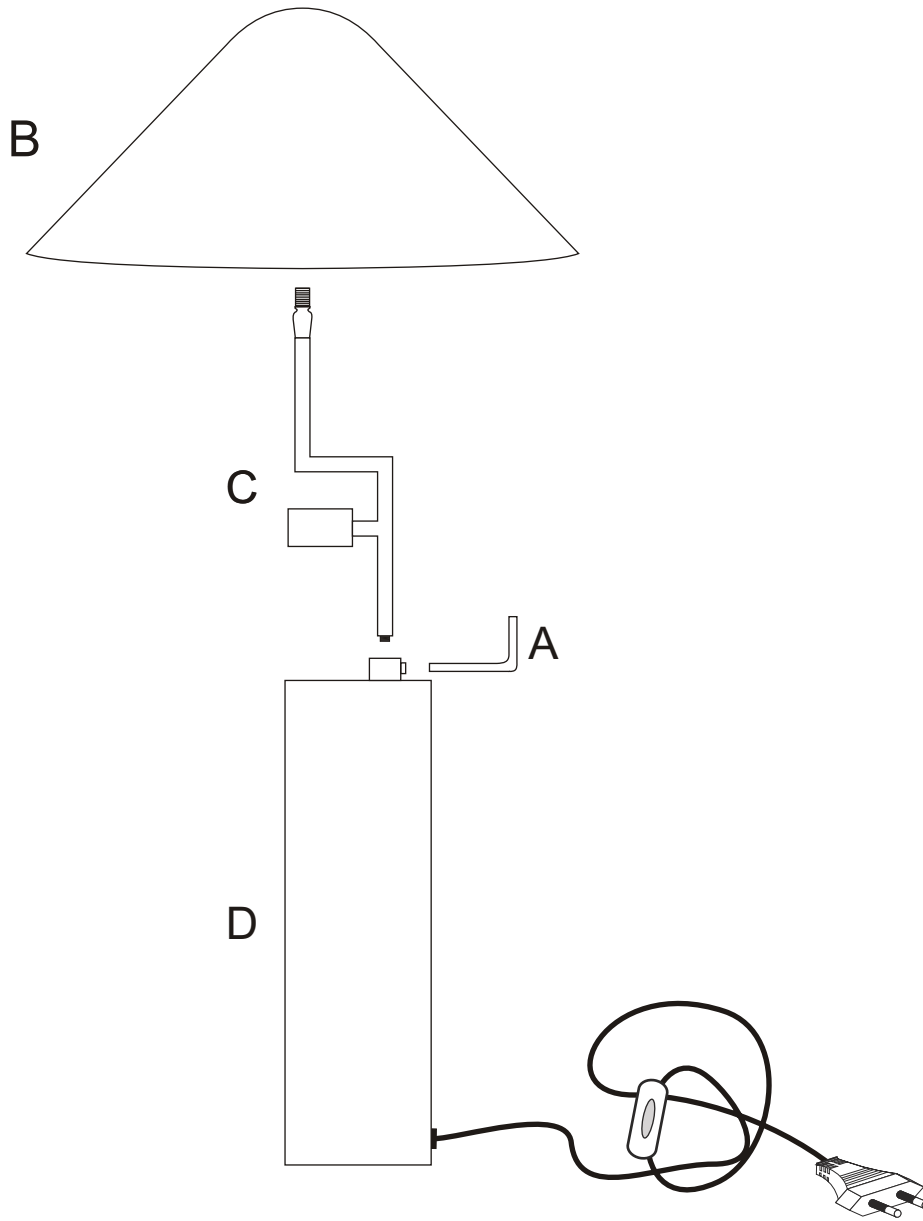

1

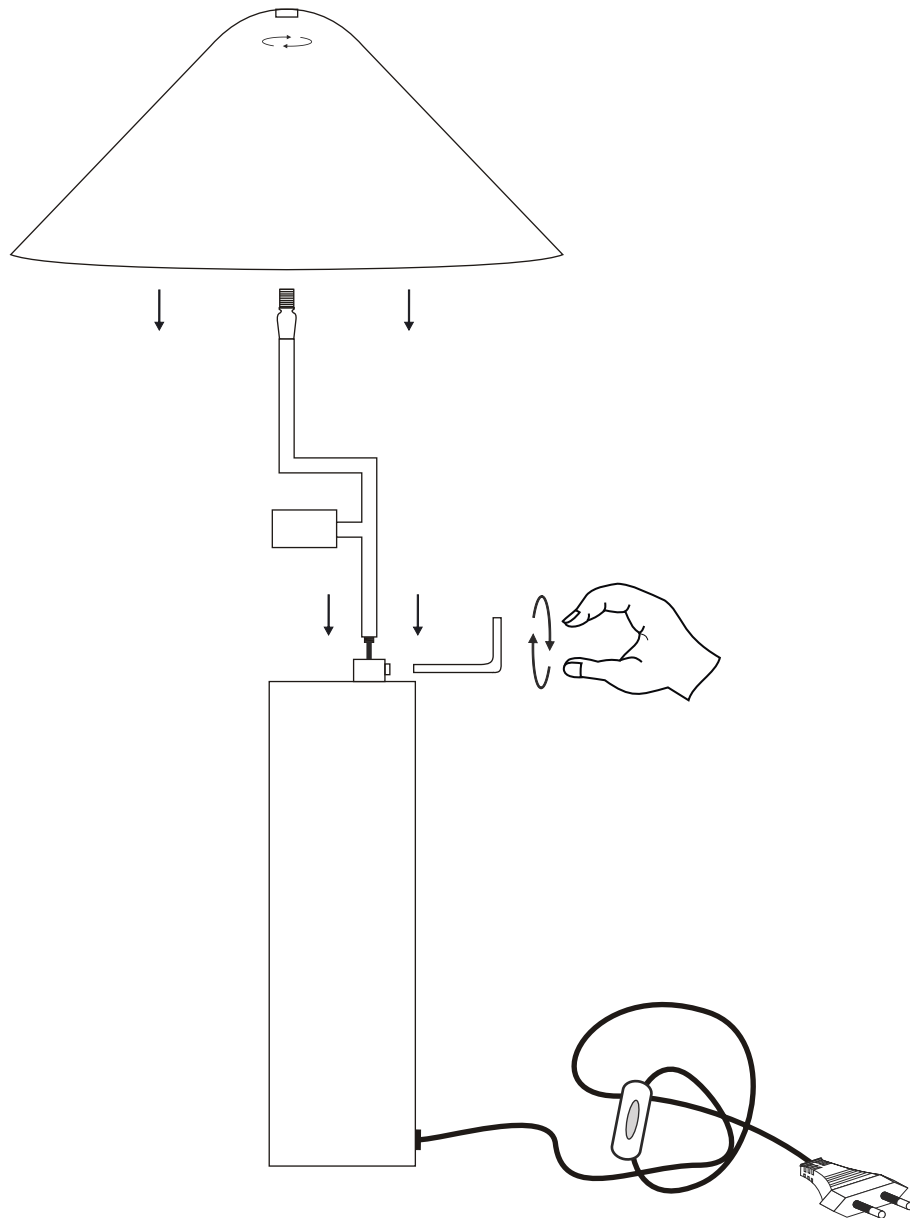

②

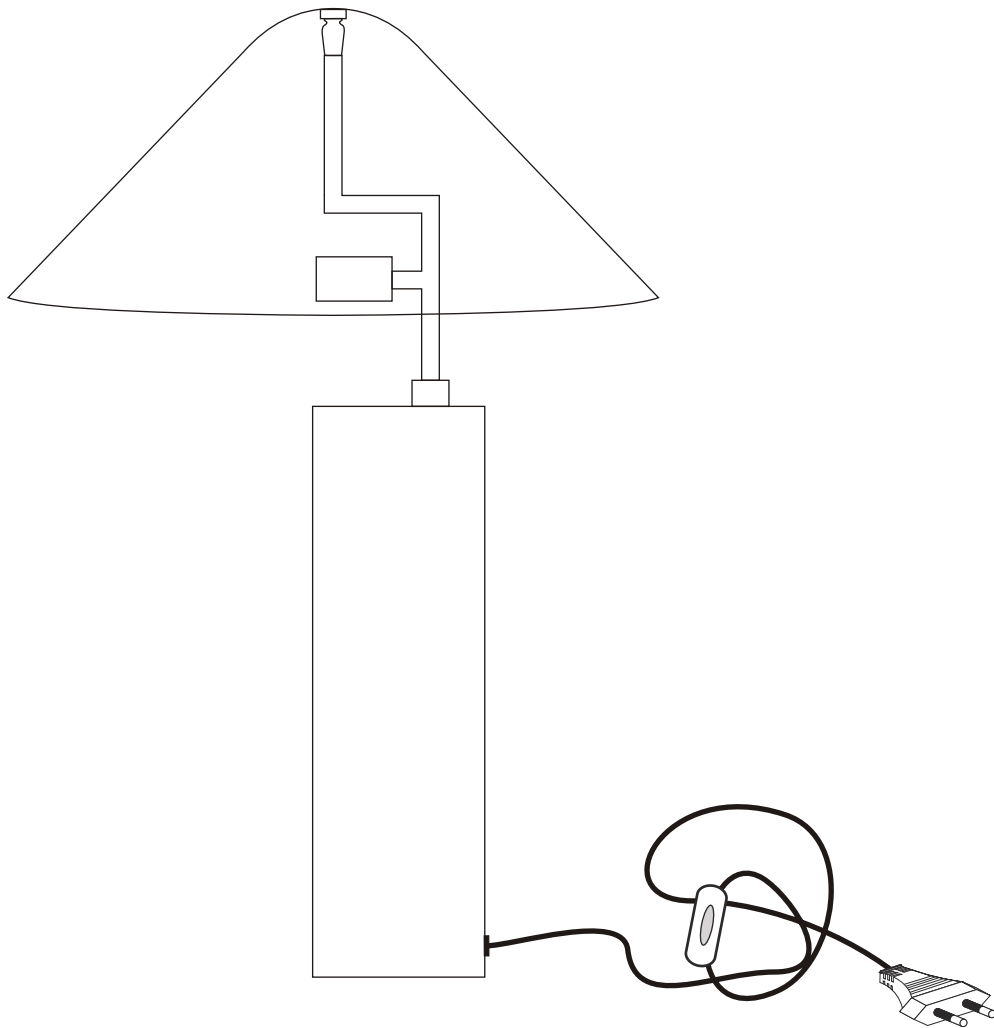

3

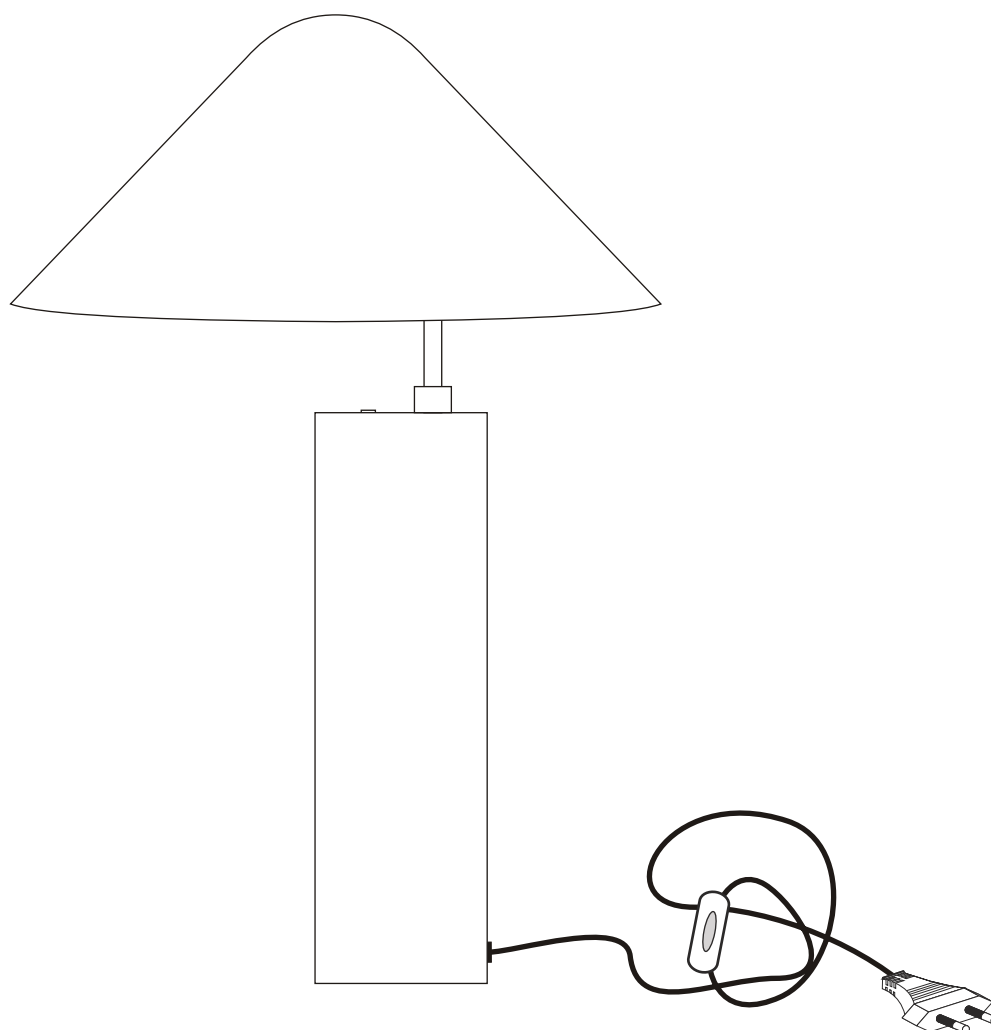



**THAT'S ALL FOLKS!**

Share your style!

**#KaveHome**

