

# BRUUT 2-DRS KAST

SCHRANK 2-TÜRIG - ARMOIRE À 2 PORTES - 2 DOOR CABINET

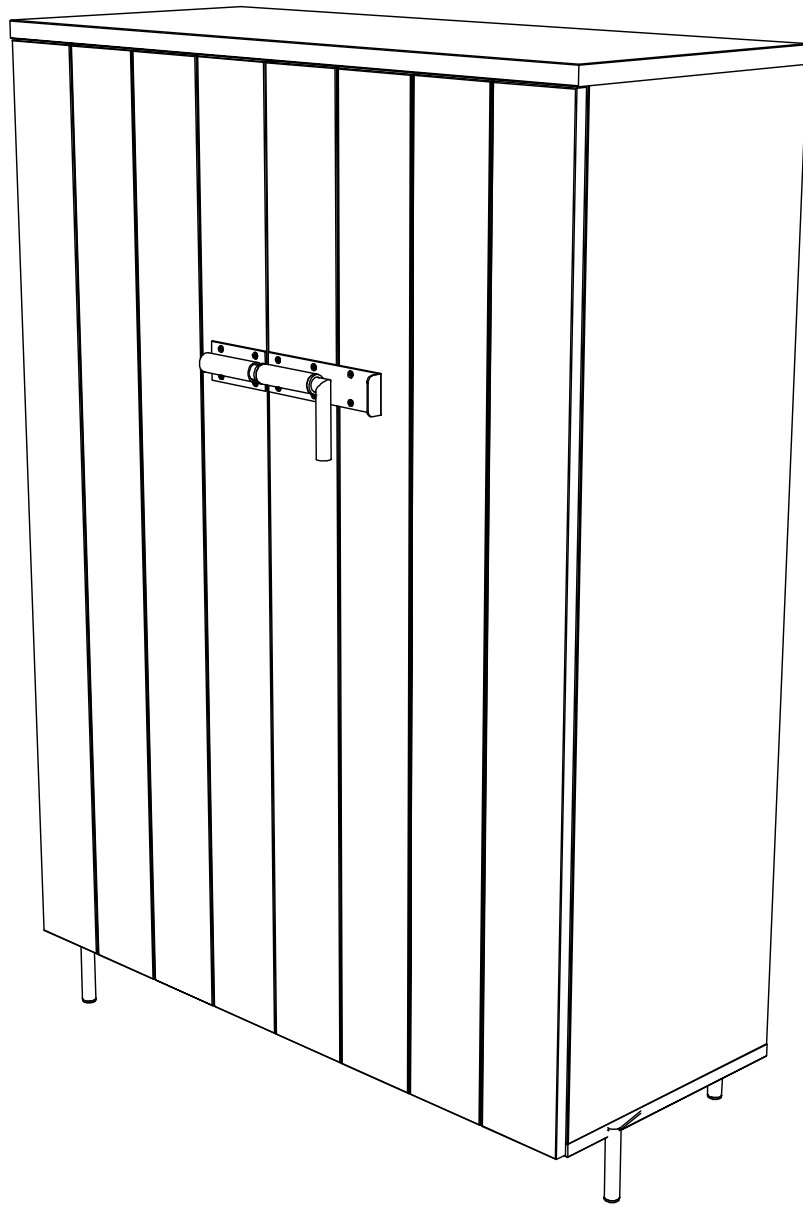

**MADE BY**  
**wood**

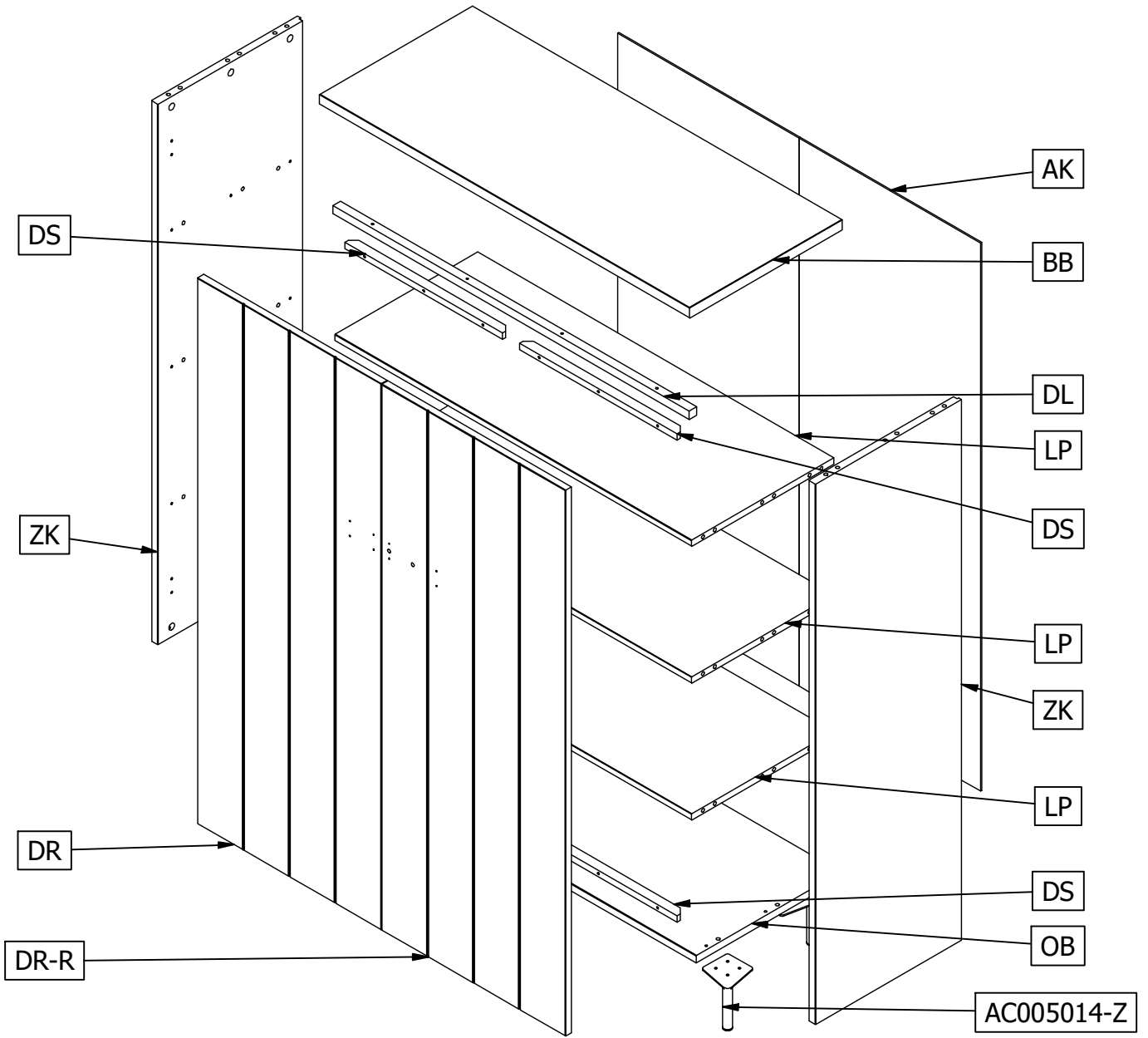



Nederlands

### WAARSCHUWING.

**Voorkom dat dit meubel omvalt. Meubels die omvallen kunnen ernstig of levensbedreigend letsel veroorzaken. Het meegeleverde kantelbeslag dient daarom BESLIST te worden gebruikt om het meubel te bevestigen aan de muur.**

Sta niet toe dat kinderen klimmen op lades, deuren of planken.  
Plaats zware voorwerpen altijd onderin.  
Zet zware voorwerpen nooit op het meubel.

Norsk

### ADVARSEL.

**Unngå at dette møbelet faller. Møbler som faller kan forårsake alvorlige eller livstruende skader. Det medleverte beslaget skal derfor ABSOLUTT brukes for å feste møbelet til veggen.**

Ikke tillat at barn klatrer på skuffer, dører eller planker.  
Plasser tunge objekter alltid nederst.  
Sett aldri tunge objekter på møbelet.

Deutsch

### WARNHINWEIS.

**Verhindern Sie, dass dieses Möbelstück umstürzt. Möbel, die umfallen, können schwere oder lebensbedrohliche Verletzungen verursachen. Zur Befestigung des Möbelstücks an der Wand sollte daher UNBEDINGT die mitgelieferte Kippsicherung verwendet werden.**

Erlauben Sie Kindern nicht, auf Schubladen, Türen oder Regale zu klettern.  
Stellen Sie schwere Gegenstände nur unten in das Möbelstück.  
Stellen Sie niemals schwere Gegenstände auf das Möbelstück.

Français

### ATTENTION.

**Évitez que le meuble ne bascule. Les meubles qui basculent peuvent être à l'origine de blessures graves ou mortelles. La fixation anti-basculement fournie avec le meuble doit OBLIGATOIREMENT être utilisée pour fixer celui-ci au mur.**

Ne laissez pas les enfants grimper sur les tiroirs, portes ou étagères.  
Placez toujours les objets lourds dans le bas du meuble.  
Ne placez jamais les objets lourds sur le meuble.

English

### CAUTION.

**Prevent this furniture from falling over. Falling furniture could cause severe or life-threatening injuries. Therefore, the included tip-over restraint HAS to be used to secure the furniture to the wall.**

Do not allow children to climb on the drawers, doors or shelves.  
Always place heavy objects at the bottom.  
Never place heavy objects on top of the furniture.

Svenska

### VARNING.

**Förhindra att denna möbel välter. Möbler som välter kan orsaka allvarliga eller livshotande skador. Det medföljande tipskyddet MÅSTE därför användas för att förankra möbelen i väggen.**

Låt inte barn klättra på lådor, dörrar eller hyllor.  
Placera alltid tunga föremål längst ned.  
Ställ aldrig tunga föremål på möbelen.

Polski

### UWAGA.

**Zabezpiecz meble przed przewróceniem. Przewrócenie się mebli może spowodować poważne lub śmiertelne obrażenia ciała. Dlatego załączone ograniczniki przechyli ZDECYDOWANIE powinny zostać wykorzystane do przymocowania mebla do ściany.**









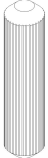
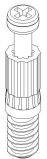
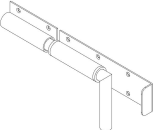

Nie pozwalaj dzieciom wspinać się na szuflady, drzwiczki lub półki.  
Zawsze umieszczaj ciężkie przedmioty w dolnej części.  
Nigdy nie stawiaj na meblu ciężkich przedmiotów.

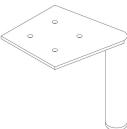
Español

### ADVERTENCIA.

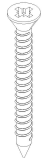
**Evite que este mueble se caiga. Los muebles que se caen pueden ocasionar lesiones graves o potencialmente mortales. Por lo tanto, el herraje abatible suministrado debe utilizarse SIN LUGAR A DUDAS para fijar el mueble a la pared.**

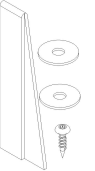
No permita que los niños se suban a los cajones, las puertas o los estantes.  
Los objetos pesados siempre deben colocarse en la parte inferior.  
Nunca coloque objetos pesados sobre el mueble.

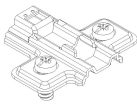
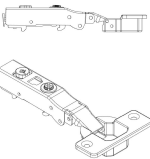
30	Ø15mm	AC000102 	30	8x35mm	AC000601 
30	24mm	AC000103 	1		AC005013-Z 
2	M6x8x12mm	AC000145 	4	H=100	AC005014-Z 
24	4x16mm	AC000204 	1	SW4	AC000216 
10	4x16mm Z	AC000204-Z 			
16	3.5x35mm	AC000219 			
32	Ø1.4x25mm	AC000316 			
1	Safety balance	AC000356 			
30	Ø14	AC000369- 			
4	14mm H=2	AC000460 			
4	0mm V	AC000461 			

1

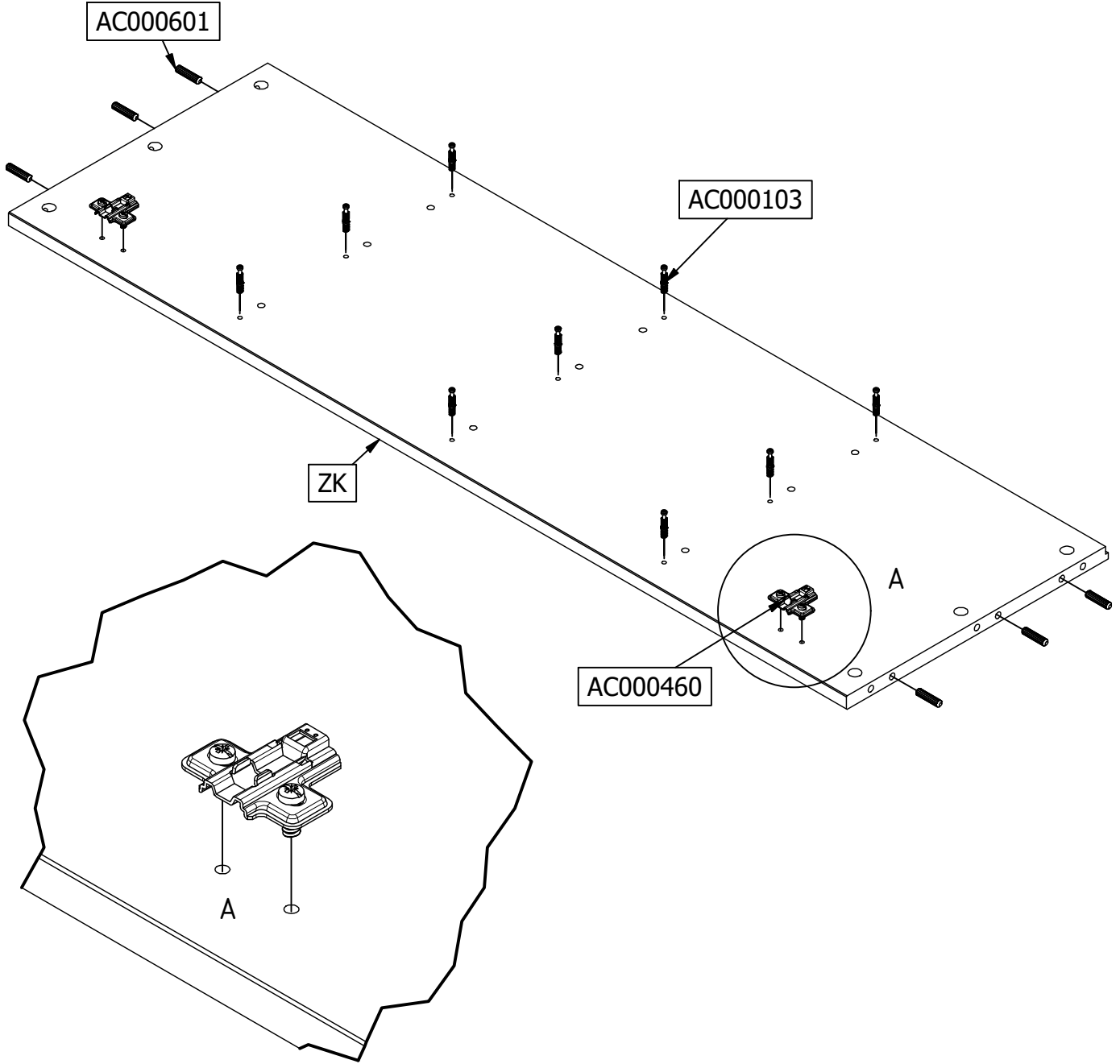
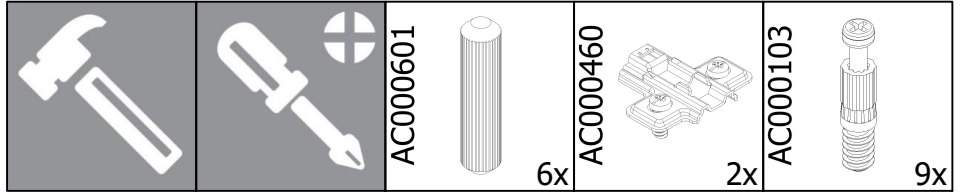

2x

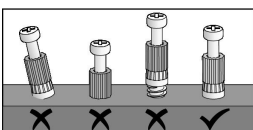

2

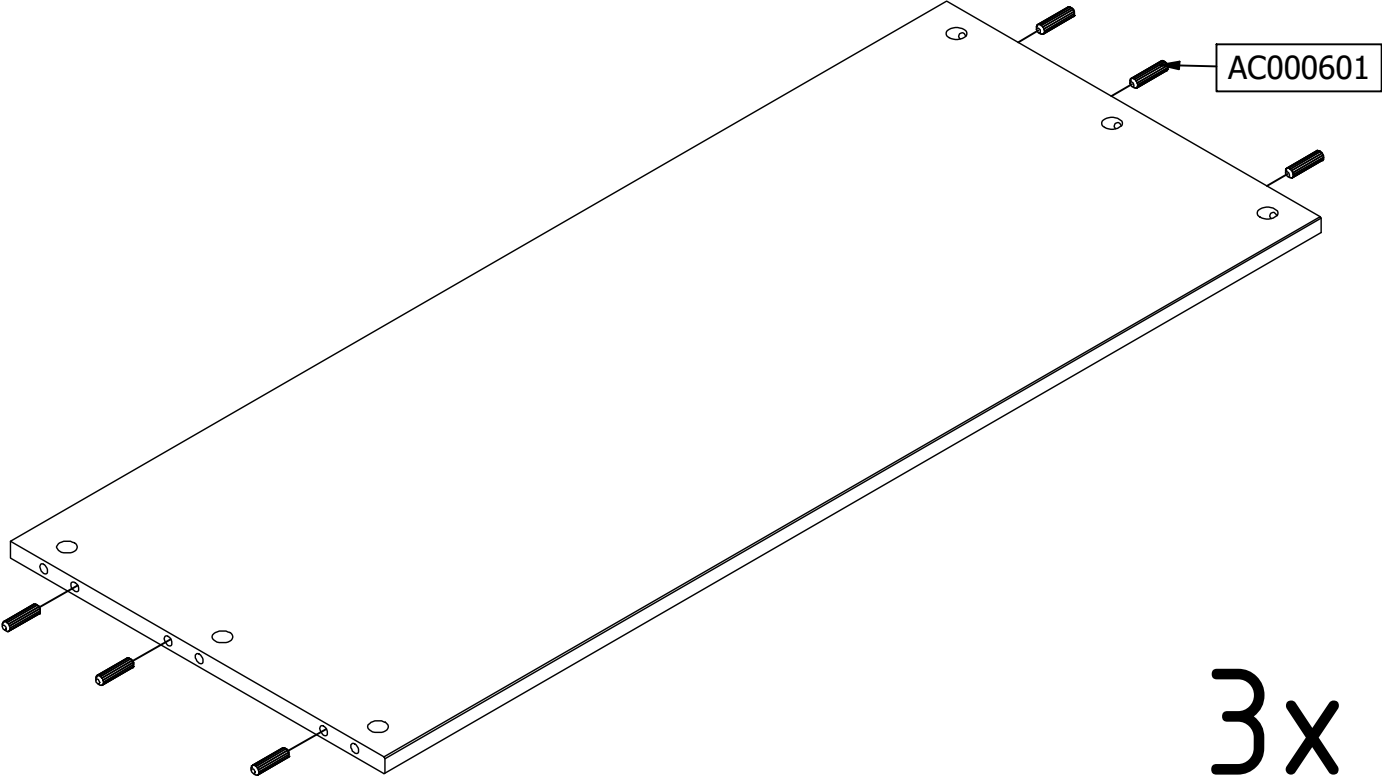
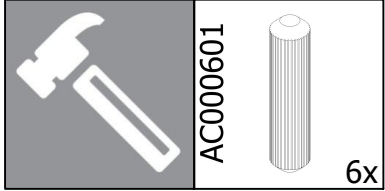

3

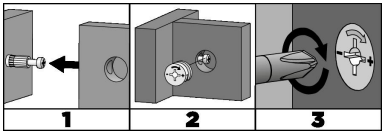
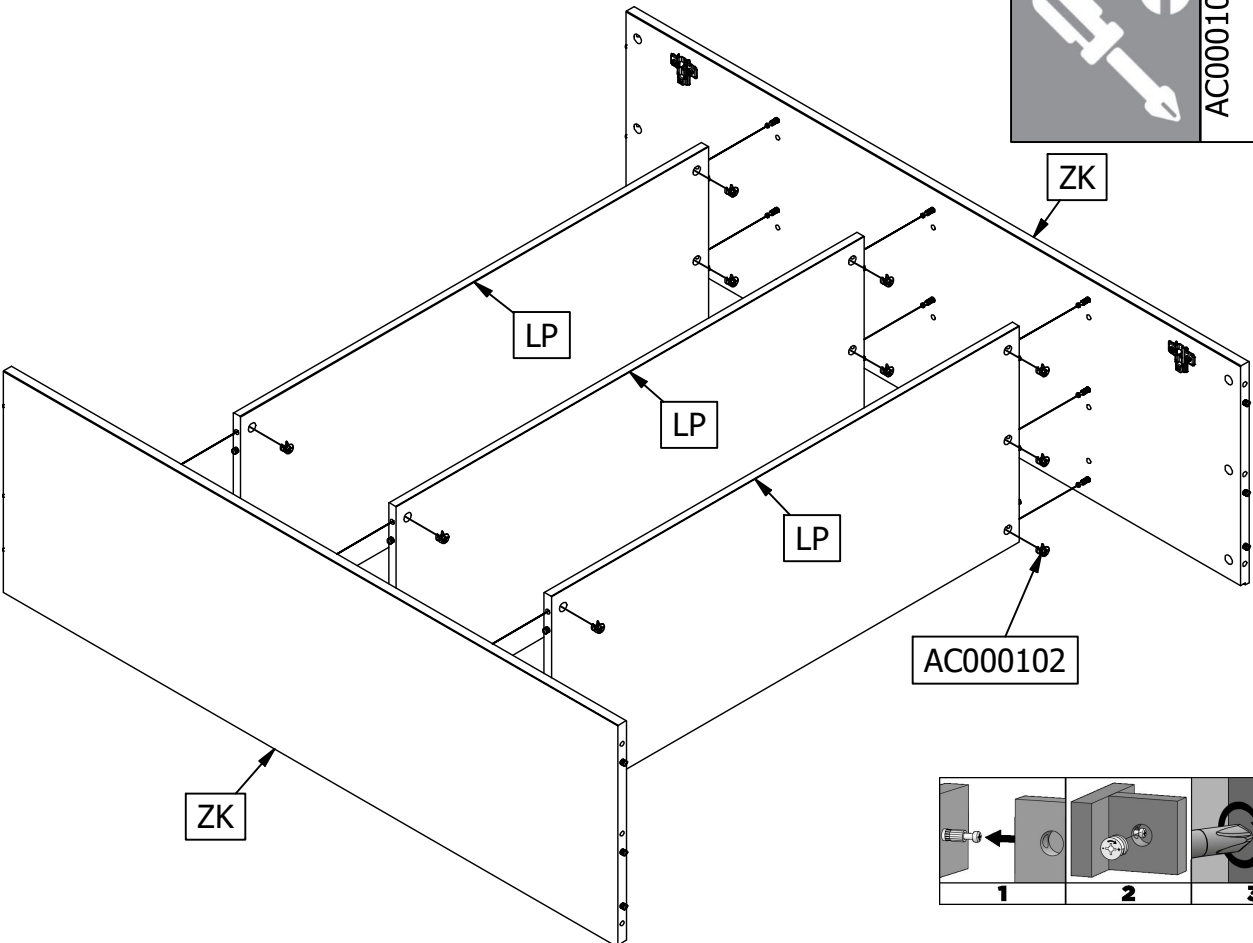
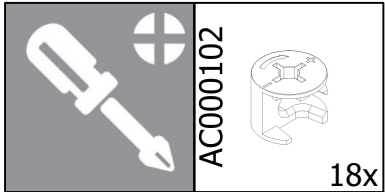

4

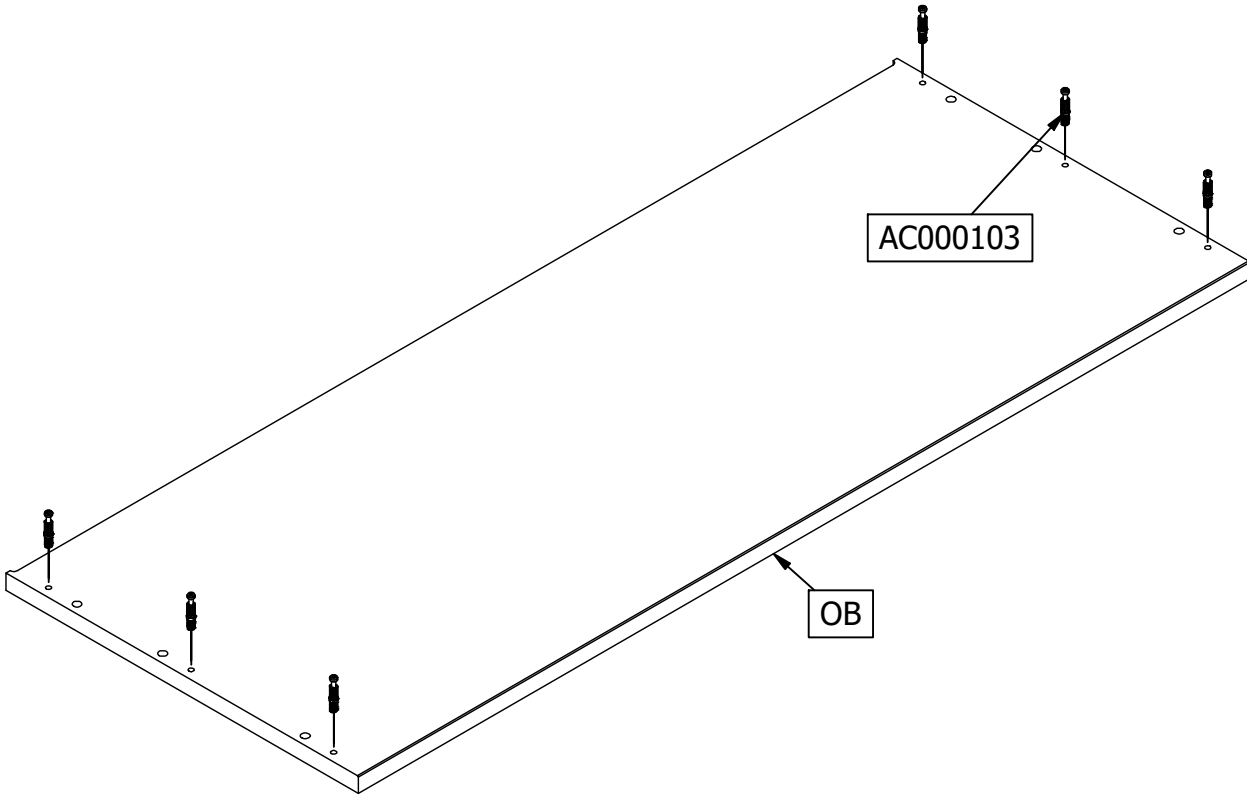
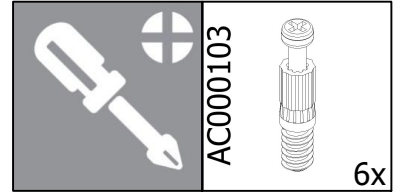
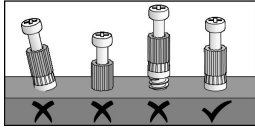

5

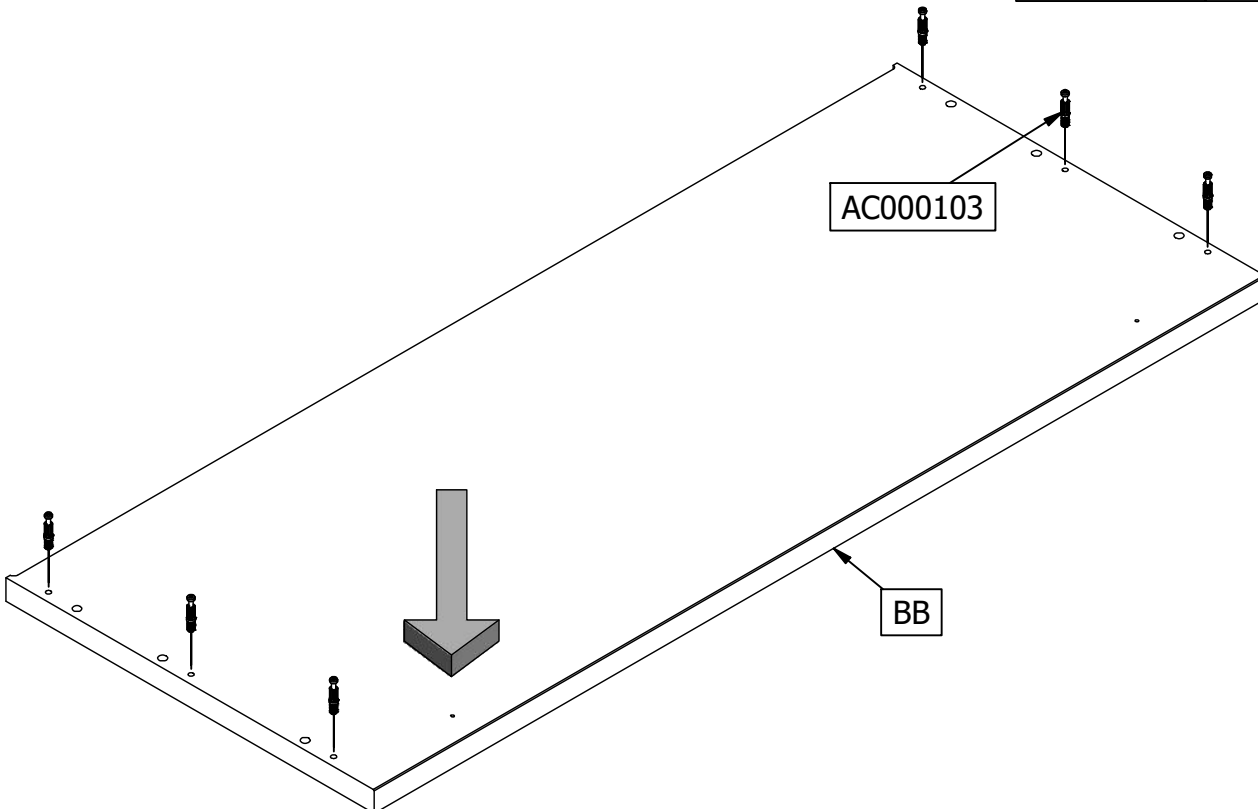
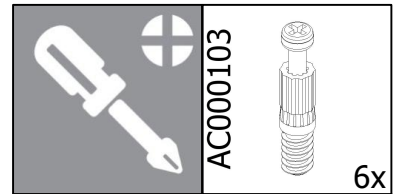
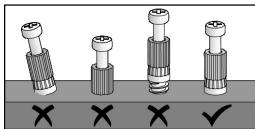

6

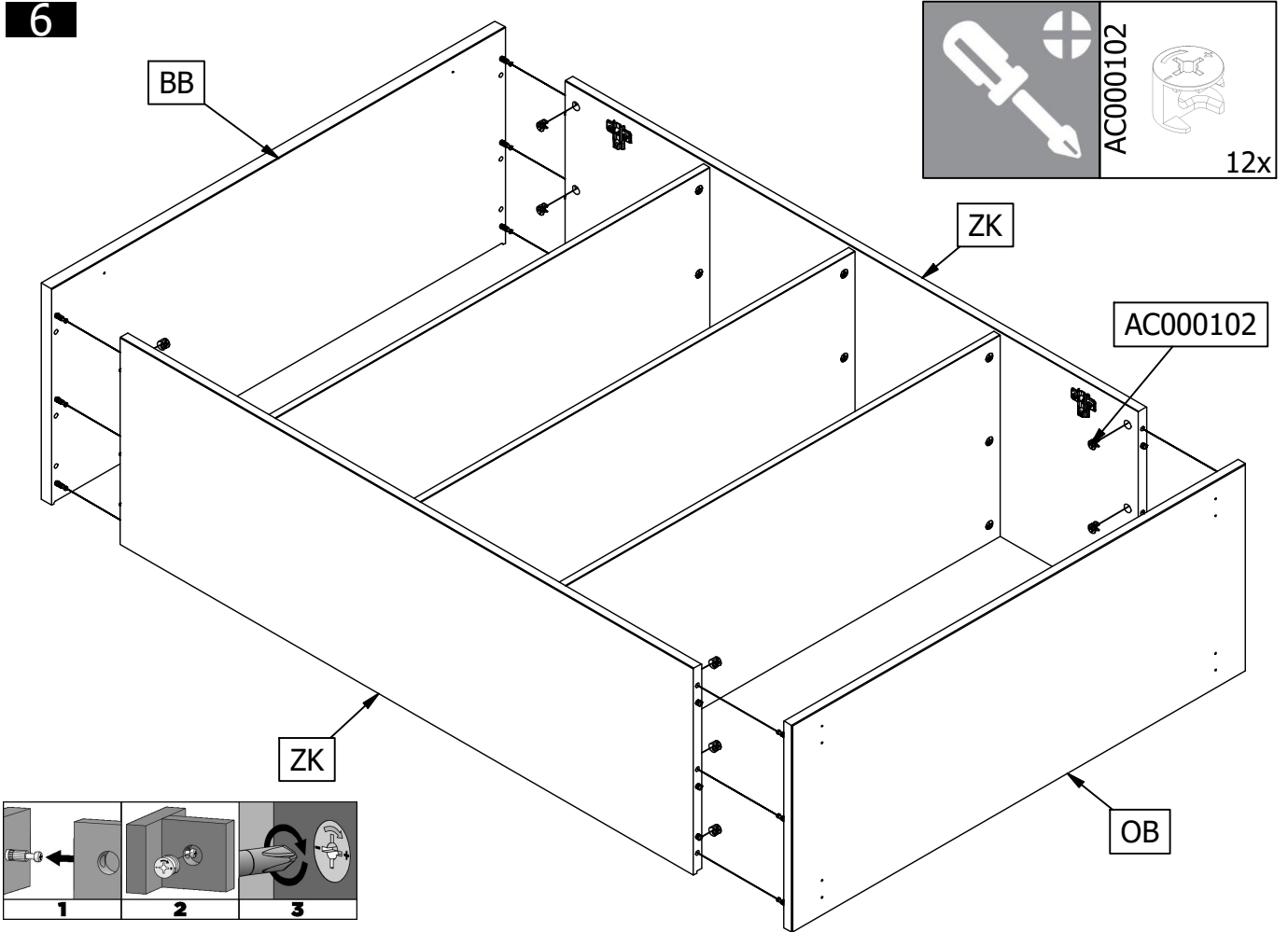

7

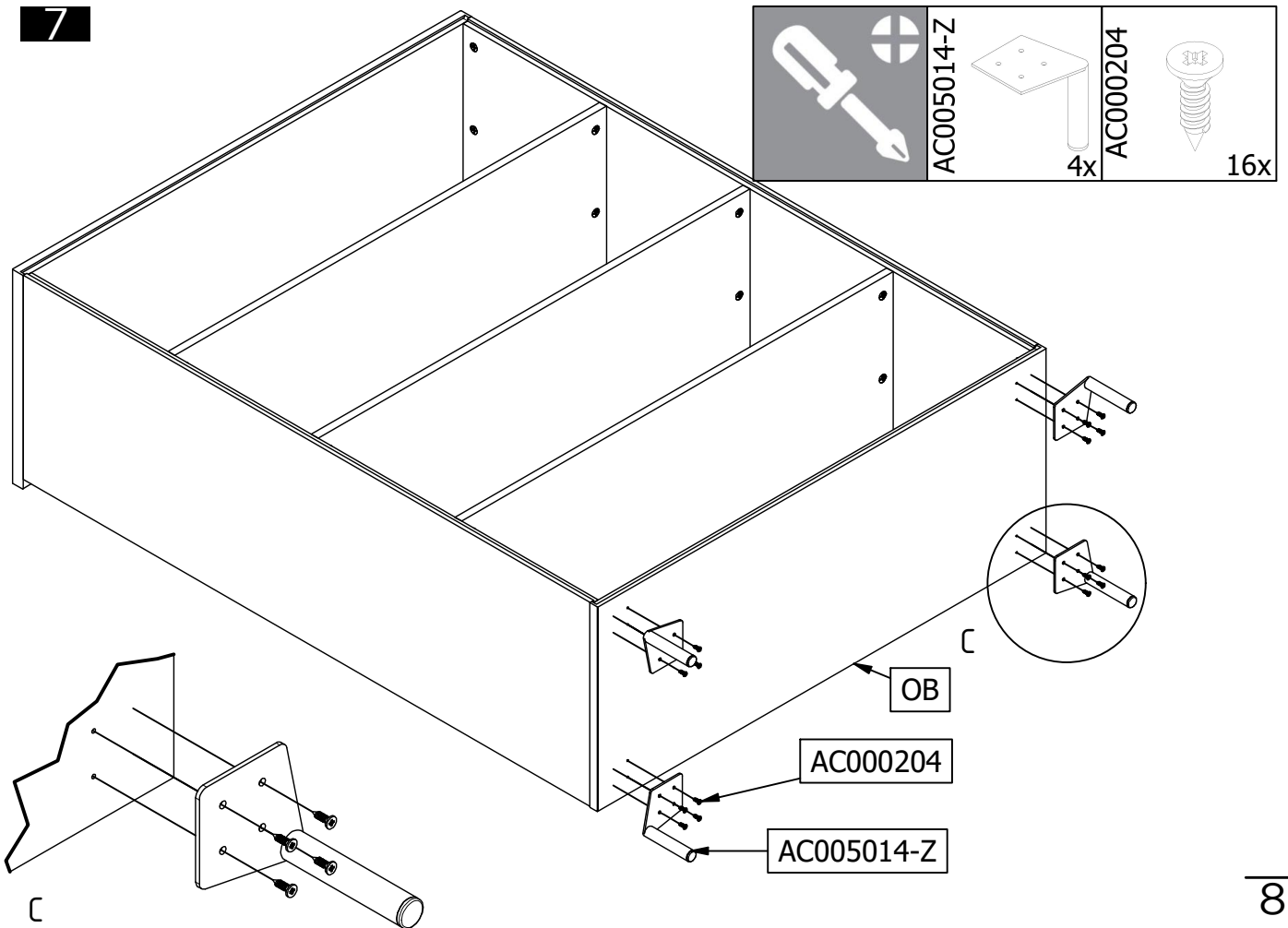





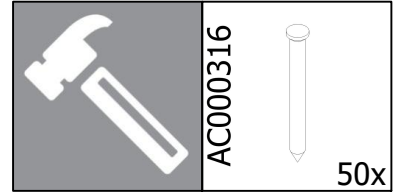
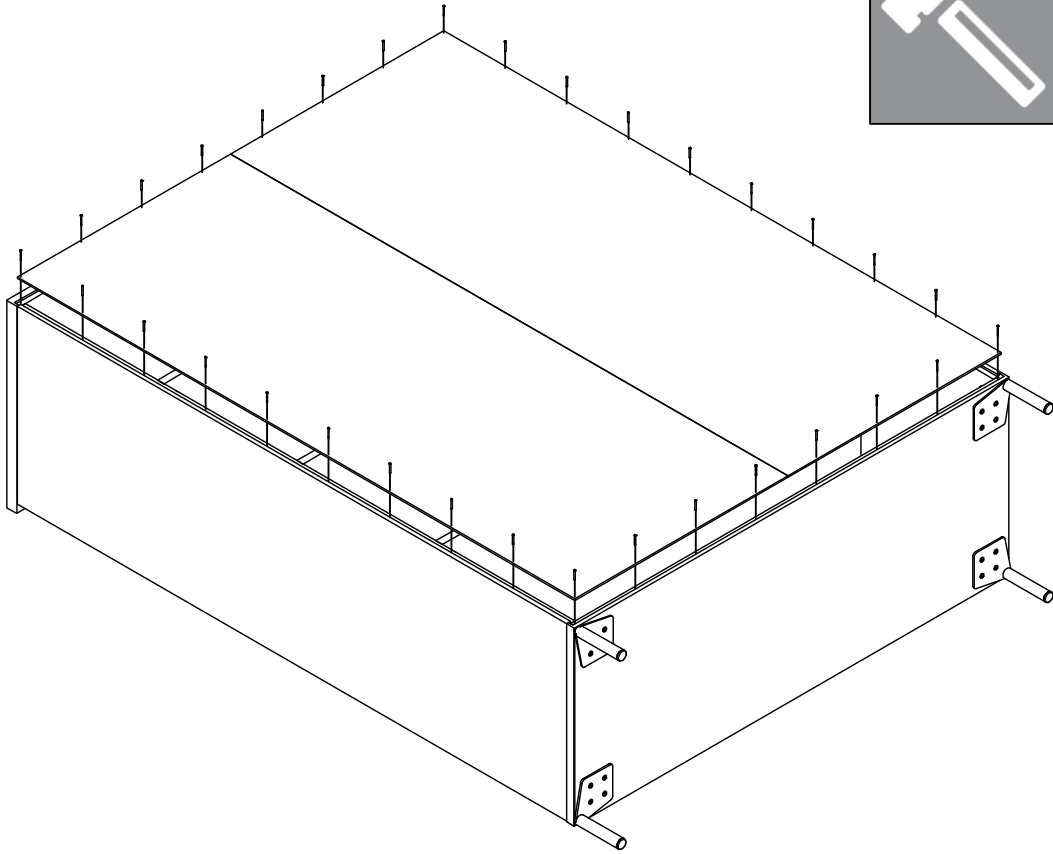

8

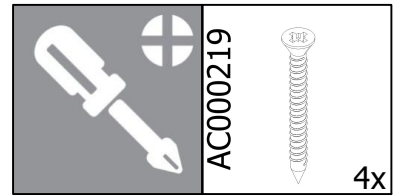
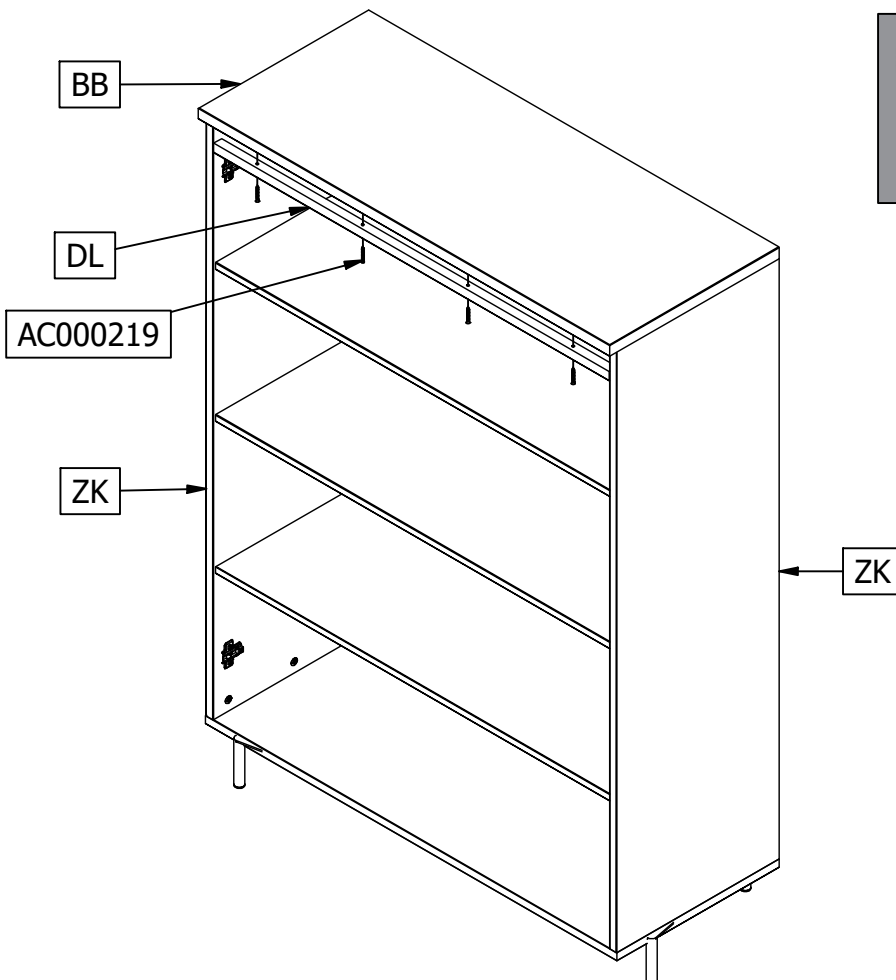

9



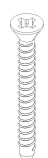

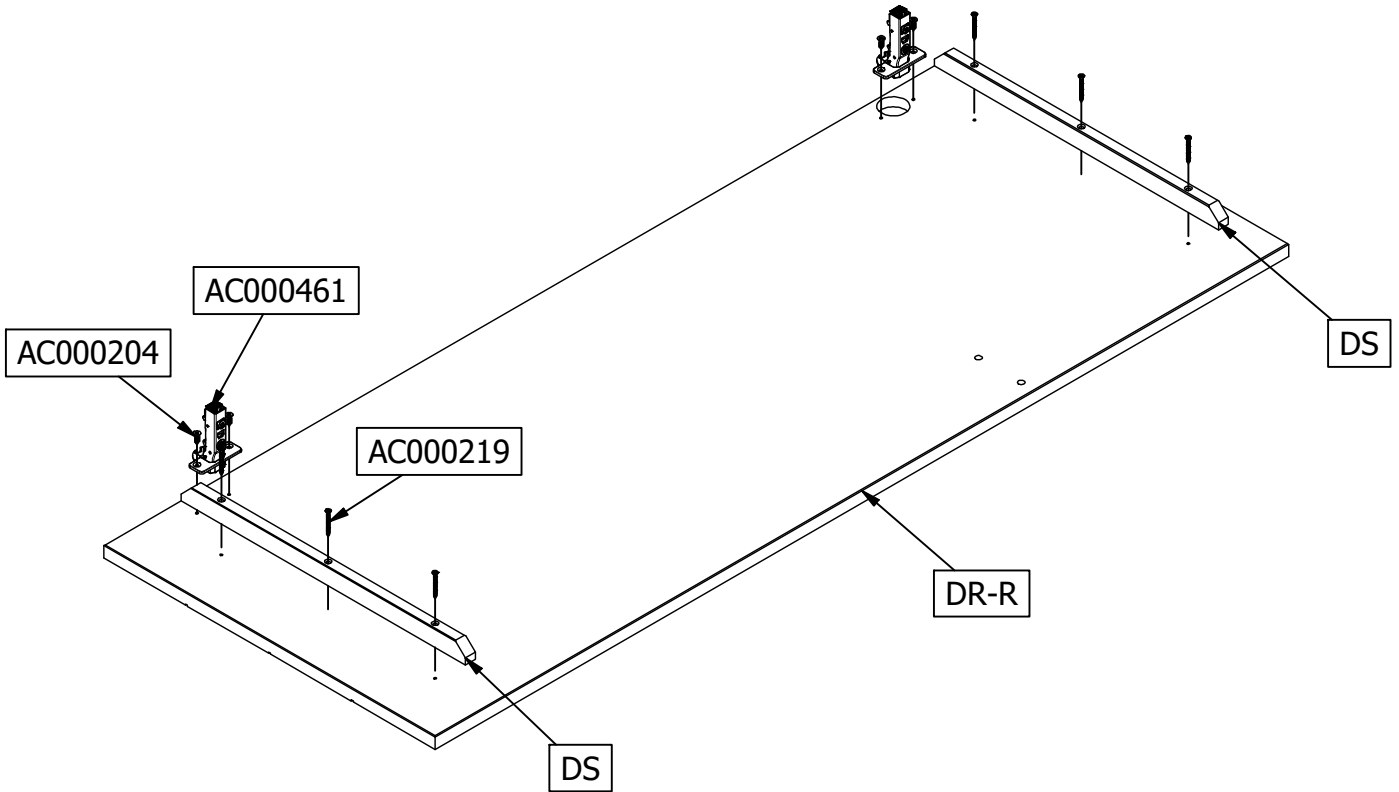

10

	 AC000461	 AC000219	 AC000204
	1x	6x	4x



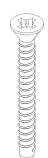

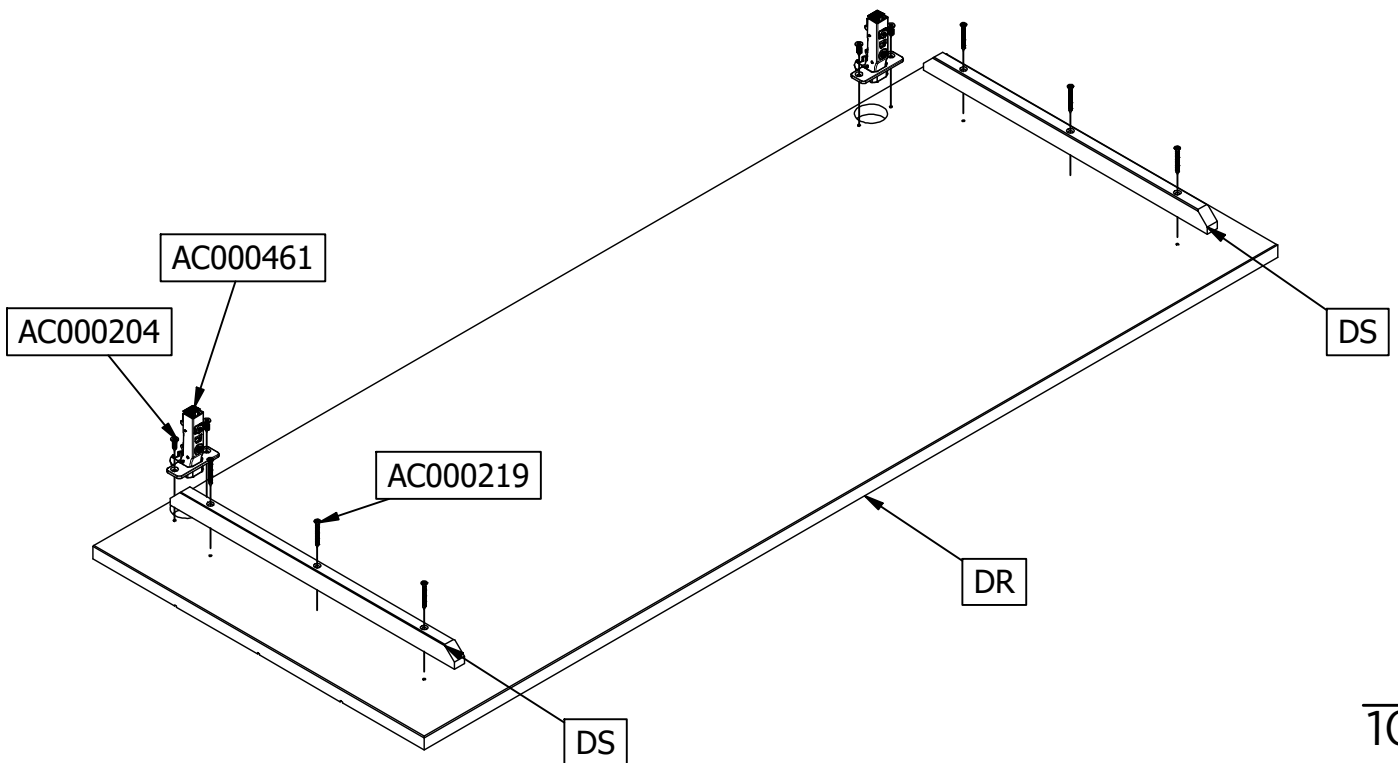

11

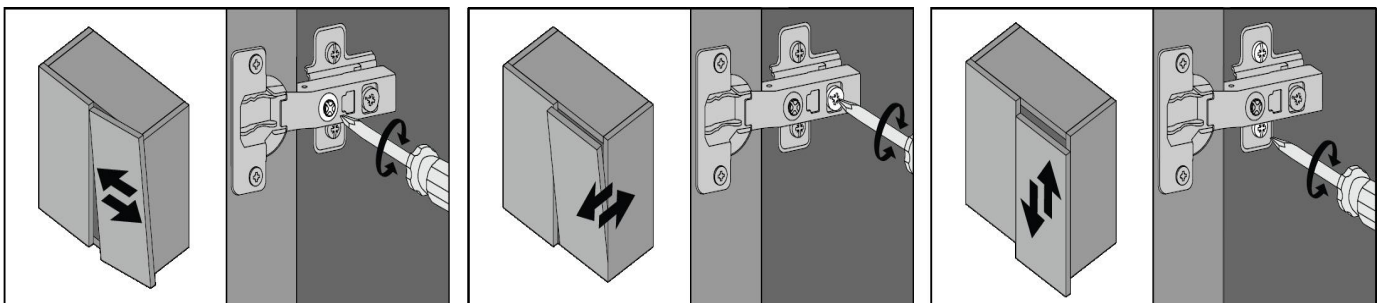
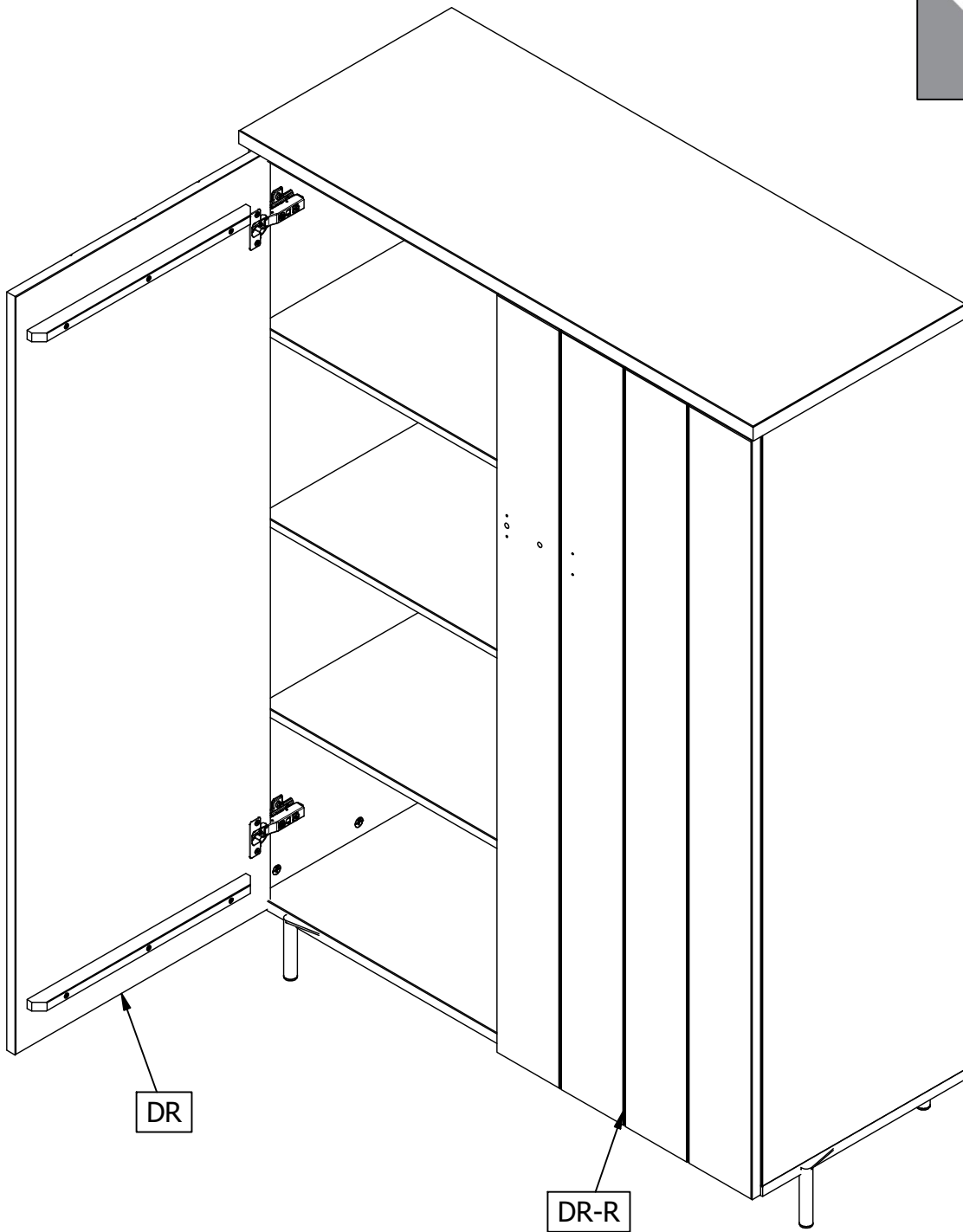
	 AC000461	 AC000219	 AC000204
	1x	6x	4x



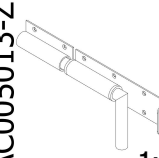

	AC000216		1x	AC000145		2x	AC005013-Z		1x	AC000204-Z		10x
---	----------	---	----	----------	--	----	------------	---	----	------------	---	-----

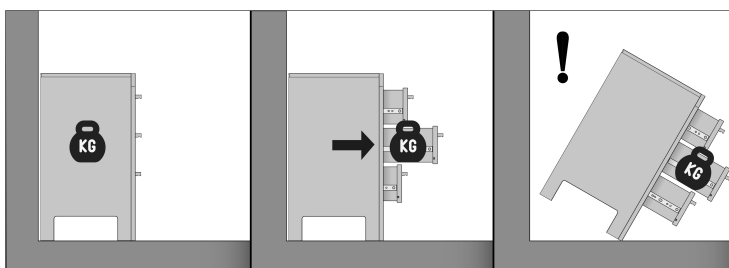
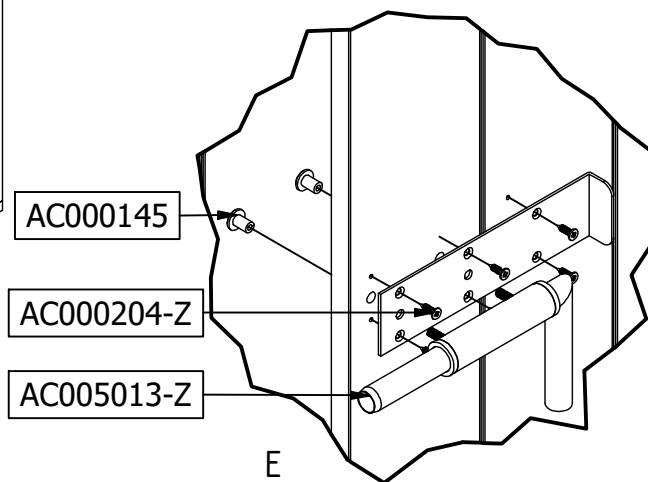
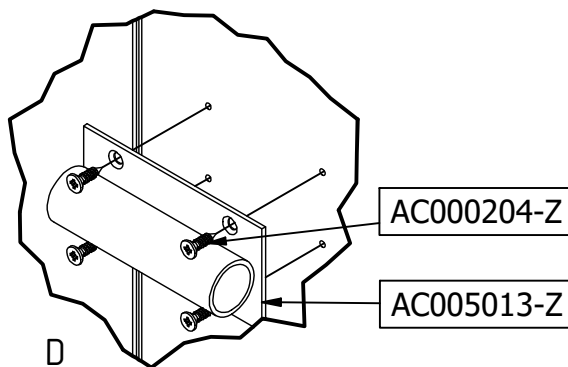
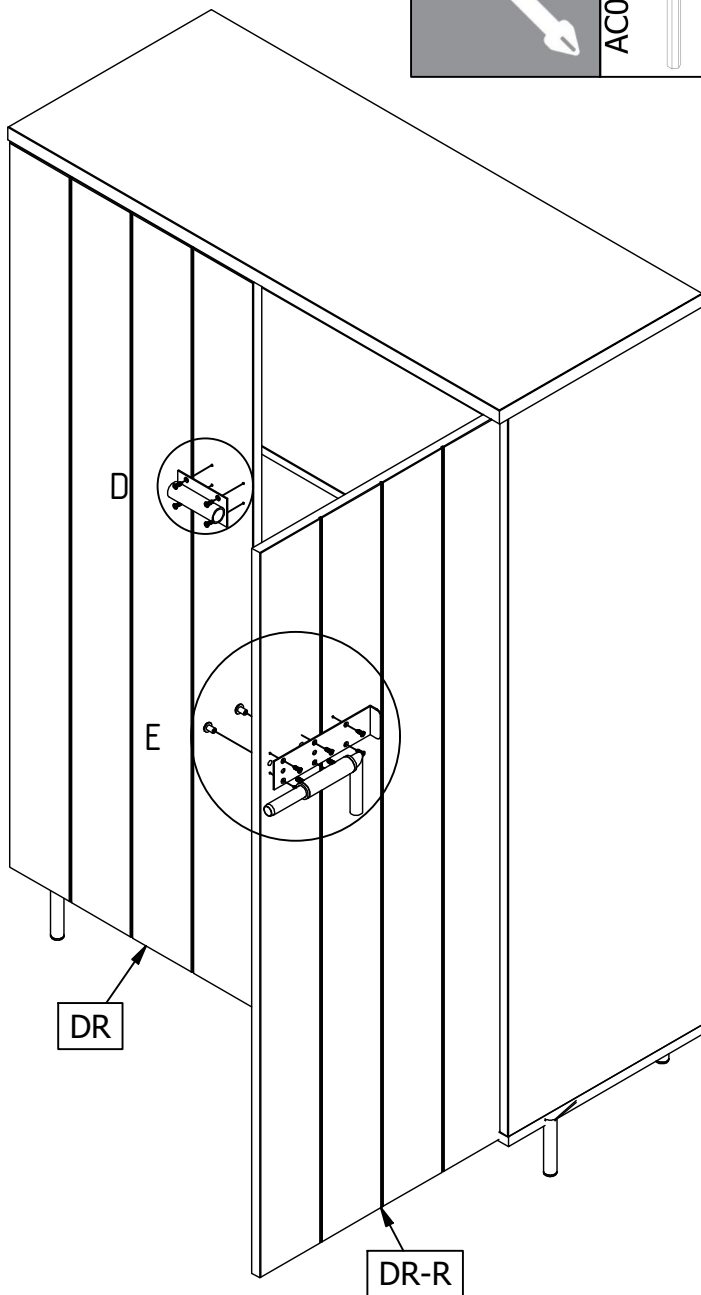

**SOCIAL MEDIA**

We zijn benieuwd naar het resultaat! Mocht je het met ons willen delen, gebruik #WOOOD op social media.  
 We are curious about the result! Would you like to share it with us? Use #WOOOD on social media.  
 Wir sind gespannt auf das Ergebnis! Möchten Sie es mit uns teilen? Benutzen Sie #WOOOD in Social Media.  
 Nous sommes impatient de connaître le résultat. Souhaitez-vous le partager avec nous? Utilisez #WOOOD sur les médias sociaux.



facebook.com/wood.nl  
 instagram.com/madebywood  
 pinterest.com/madebywood