

**NOTICE DE MONTAGE  
ASSEMBLY INSTRUCTIONS  
MONTAGEANLEITUNG  
ISTRUZIONI DI MONTAGGIO  
INSTRUÇÕES DE MONTAGEM  
INSTRUCCIONES DE MONTAJE  
UPUTE ZA MONTAZU  
MONTAJ TALIMATI**

15646 - 15928

MESA RECT. 160 CM  
TABLE RECT 160 CM  
RECT. TABLE 160CM

**ME**  
marckeric

MARCKERIC S.L.  
C / ENLACE VEROLA S/N,  
PC: 46430/SOLLANA / VALENCIA / SPAIN

EAN CODE

8435178393043  
8435178395689

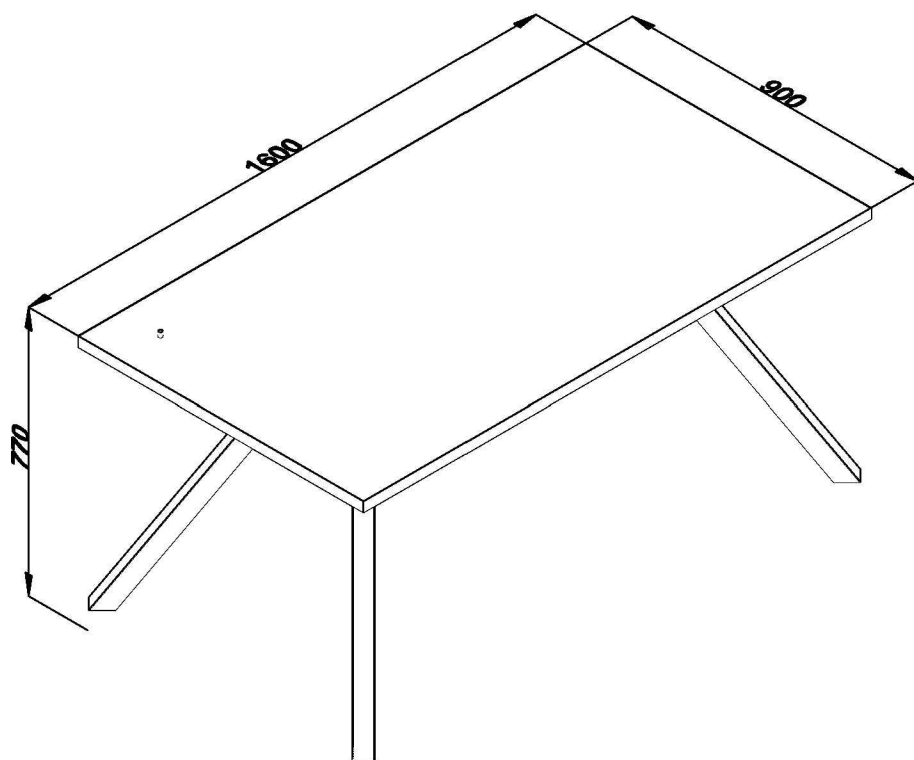

À MONTER SOI-MÊME

**AVANT DE COMMENCER, SE  
REPORTER AUX CONSEILS  
DE MONTAGE EN ANNEXE**

**BEFORE STARTING, REFER  
TO THE ASSEMBLING ADVICE  
IN ANNEX**

**VOR DER MONTAGE,  
BEILIEGENDE ANWEISUNGEN  
BEFOLGEN.**

**PRIMA DI COMINCIARE  
LEGGETE LE ISTRUZIONI DI  
MONTAGGIO**

**ANTES DE COMENÇAR, ADIAR  
SE AOS CONSELHOS DE  
MONTAGEM EM ANEXO**

**ANTES DE EMPEZAR  
CONSULTE LOS CONSEJOS  
PARA EL MONTAJE**

**PRIJE POČETKA MONTAŽE  
MOLIMO PAŽLJIVO  
PROČITAJTE UPUTE ZA  
MONTAŽU**

**BASLAMADAN ÖNCE,  
EKTEKI MONTAJ TALIMATLARINI  
İNCELEYİNİZ**

Caja Colis	Tamaño de la caja Dimensions colis	Peso bruto Poids brut	Peso neto Poids net
1/2	1688 x 952 x 39	31,5 Kg	30,9 Kg
2/2	895 x 290 x 60	8,2 Kg	7,6 Kg

"IMPORTANT- À CONSERVER POUR RÉFÉRENCE ULTÉRIEURE-LIRE ATTENTIVEMENT"  
NE PAS UTILISER SI UNE PARTIE EST CASSÉE. ENDOMMAGÉE OU MANQUANTE.

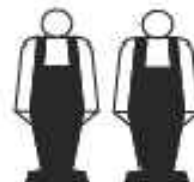
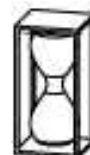
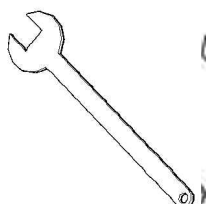

0h:25 min

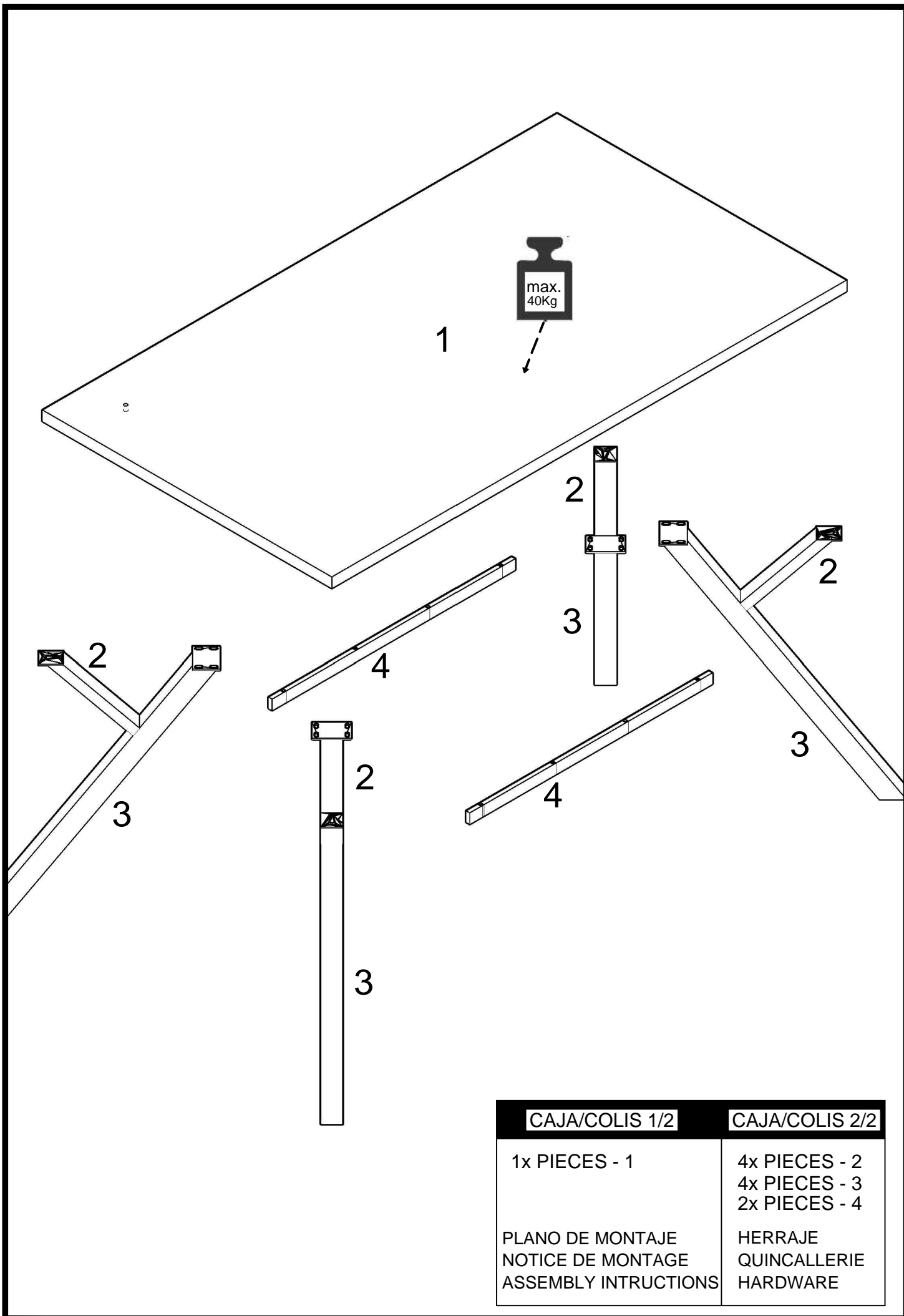

CAJA/COLIS 1/2	CAJA/COLIS 2/2
1x PIECES - 1	4x PIECES - 2 4x PIECES - 3 2x PIECES - 4
PLANO DE MONTAJE NOTICE DE MONTAGE ASSEMBLY INSTRUCTIONS	HERRAJE QUINCALLERIE HARDWARE

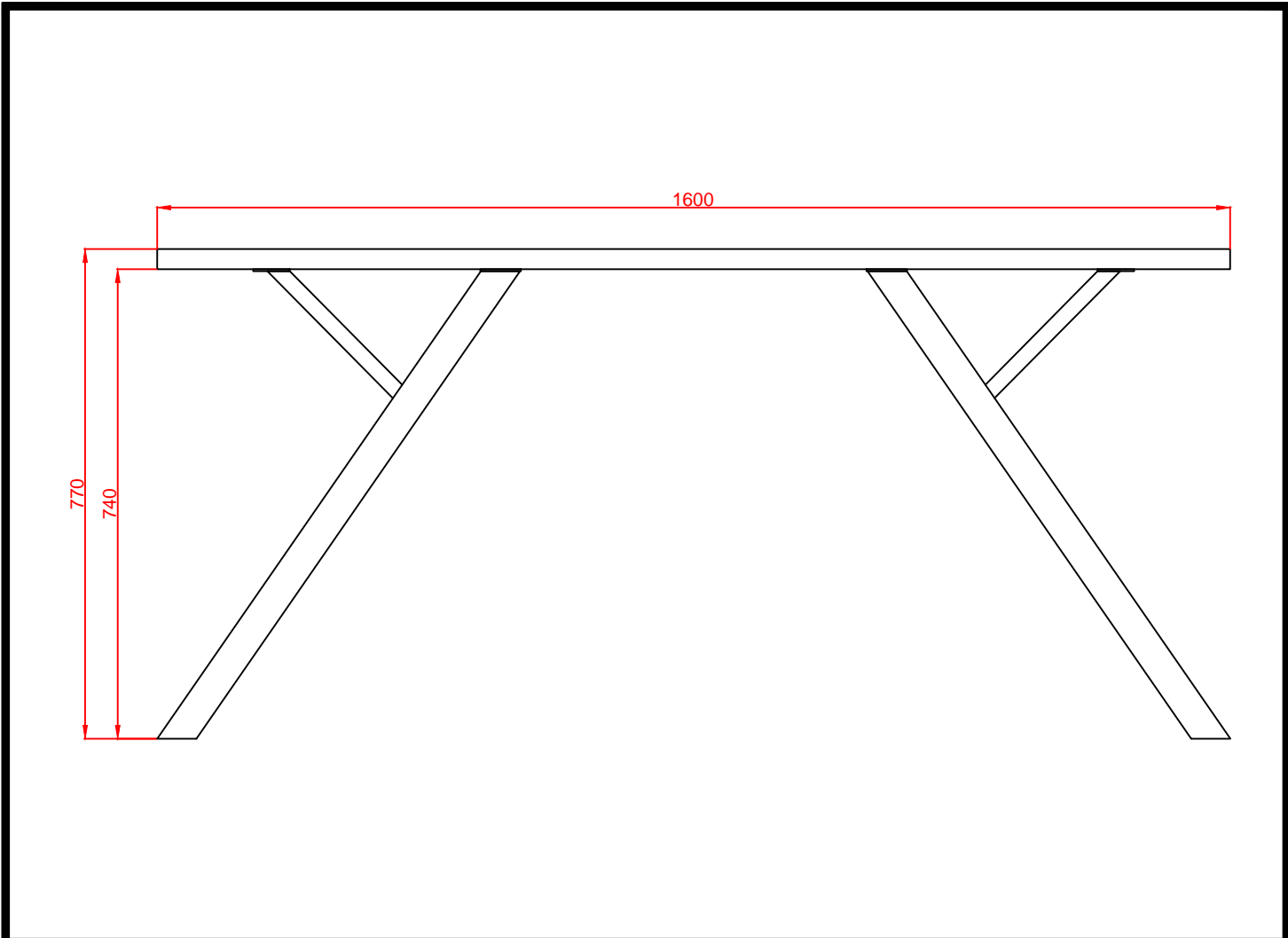

1

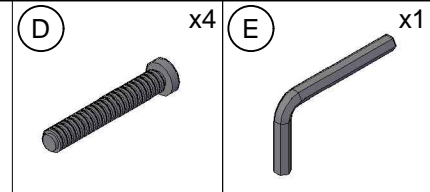
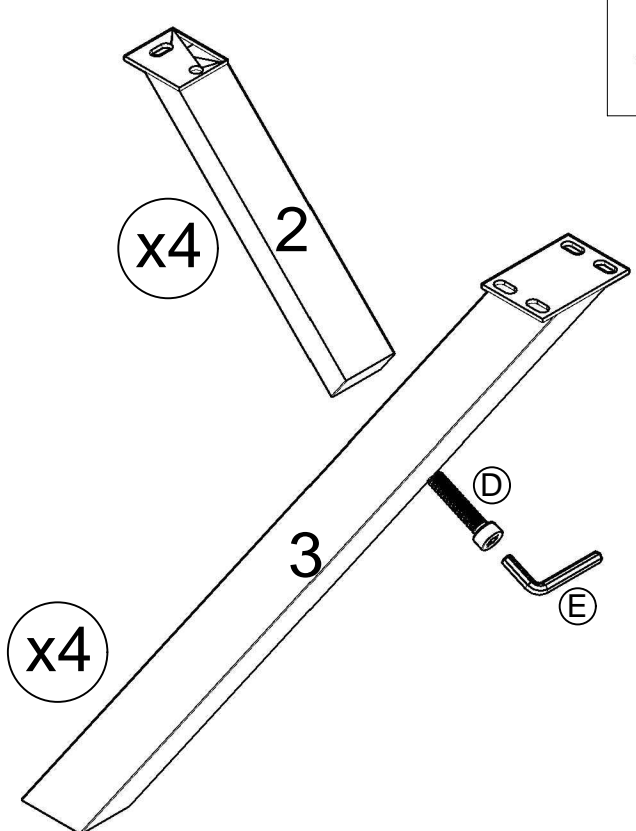

# LISTADO DE PIEZAS - COMPOSANTS - PARTS LIST

1

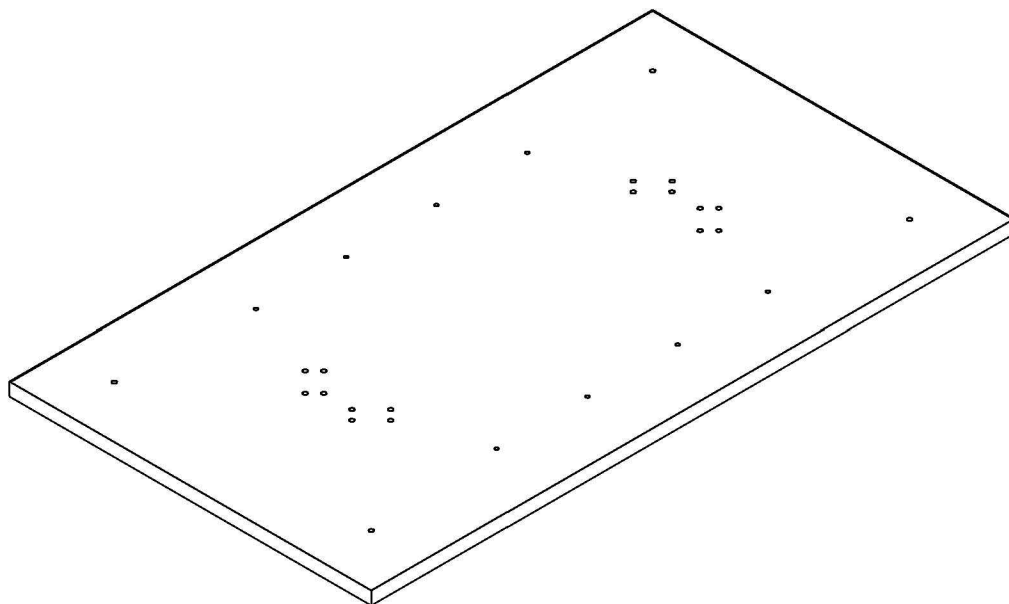

1EN9199

1 Pc

1600 x 900 x 30

2

3

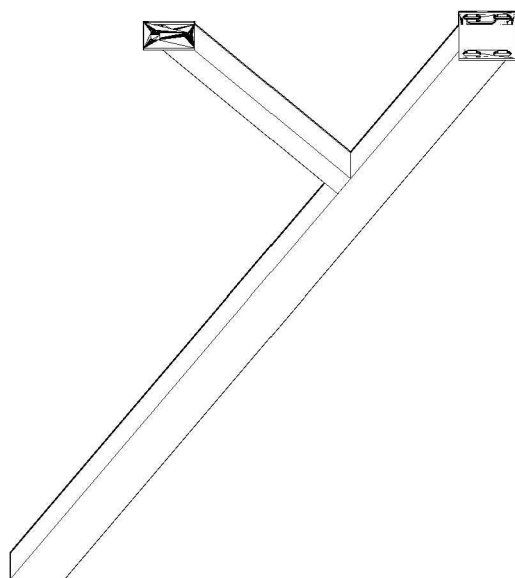

PATAS

4 Pc

740 x 47 x 40

4

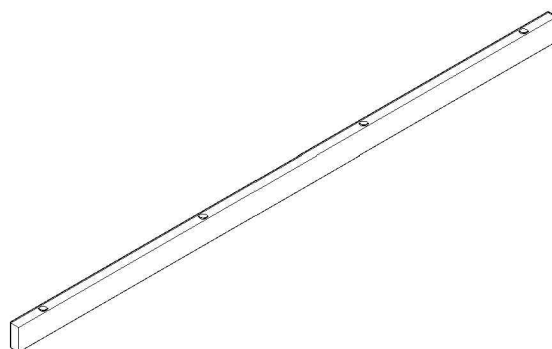

REFUERZO

2 Pc

755 x 30 x 10

# HERRAJES - QUINCALLERIE - HARDWARE

<p>(A)  x28 TUERCA M8/10x14</p>	<p>(B)  x20 TORNILLO M8X20</p>	<p>(C)  x1 LLAVE 8 mm</p>
<p>(D)  x4 TORNILLO M8x70</p>	<p>(E)  x1 LLAVE 5 mm</p>	<p>(F)  x28 ARANDELA</p>
<p>(G)  x4 TOR.SUELO PATAS</p>	<p>(H)  x8 TORNILLO M8X50</p>	

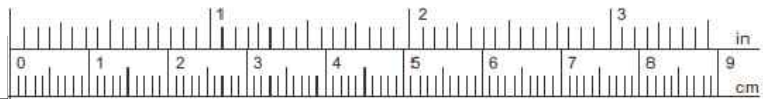

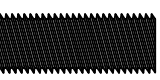
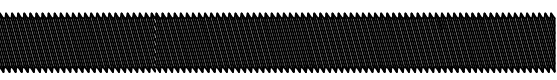
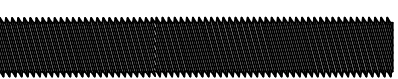
<p>(A)</p>		<p>M8x14</p>
<p>(B)</p>		<p>M8x20</p>
<p>(D)</p>		<p>M8x70</p>
<p>(H)</p>		<p>M8x50</p>

2

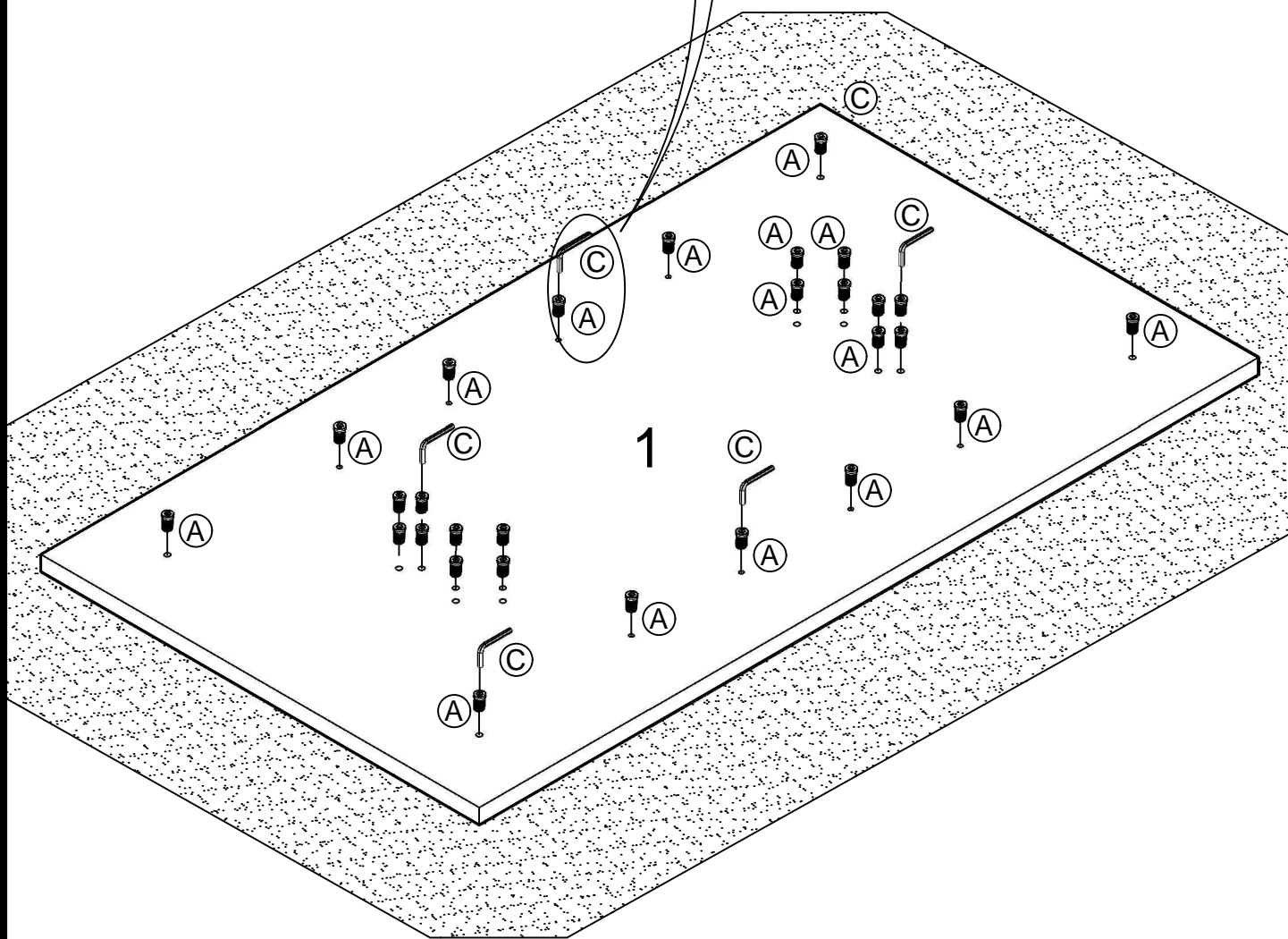
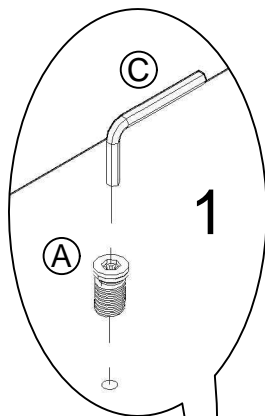
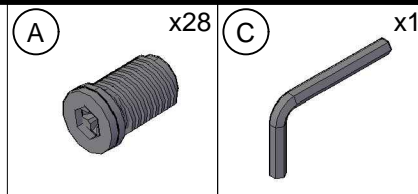

"UTILISATION D'UNE COUVERTURE RECOMMANDÉE AFIN DE NE PAS ABIMER LES PIÈCES LORS DU MONTAGE"

3

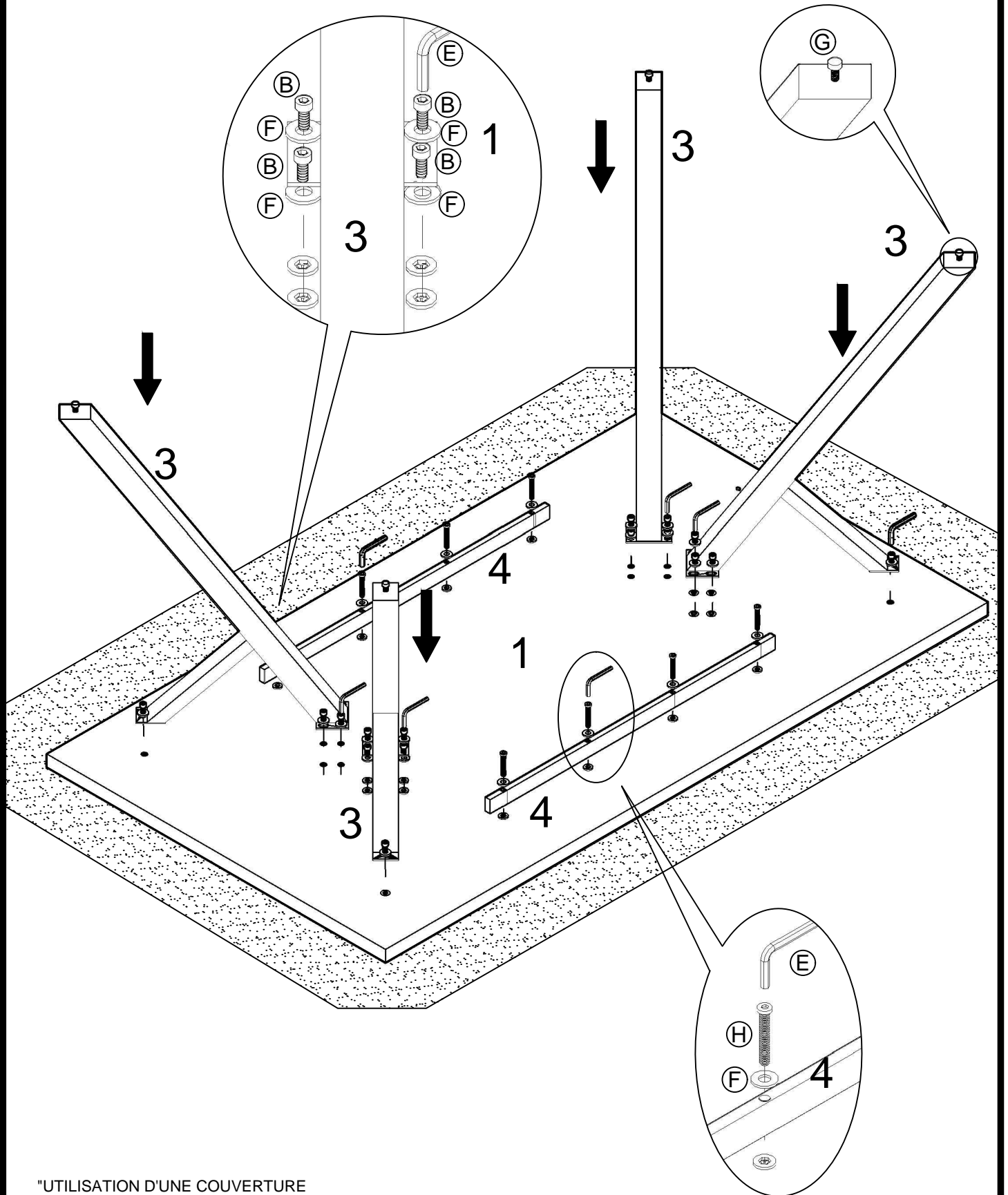
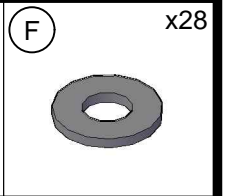
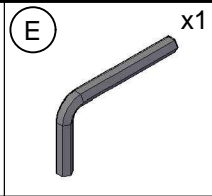
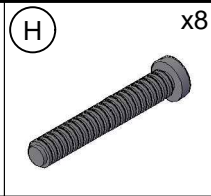
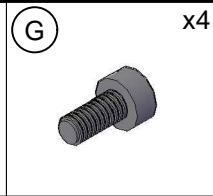
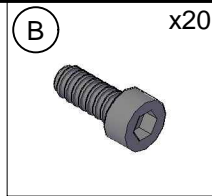

"UTILISATION D'UNE COUVERTURE RECOMMANDÉE AFIN DE NE PAS ABIMER LES PIÈCES LORS DU MONTAGE"

4

(!): ATTENTION LORS DU BASCULEMENT DE LA TABLE.

(!): TENER CUIDADO AL INCLINAR LA MESA.

(!): BE CAREFUL WHEN TIPPING THE TABLE.

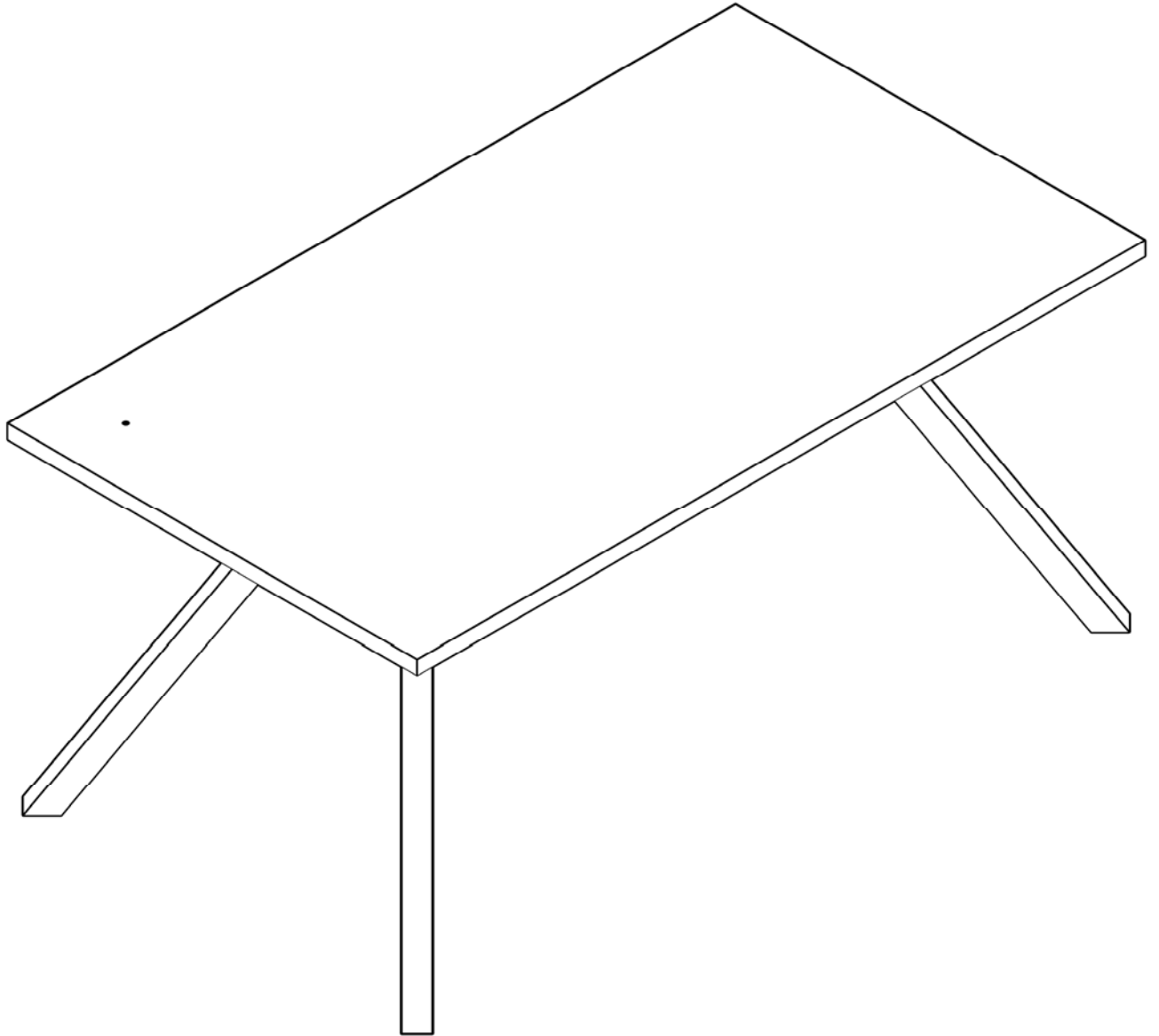

FRANCES: "Après assemblage de ce produit, il est conseillé d'aérer régulièrement la pièce pendant quelques jours".

INGLES: "After assembling this product, it is recommended to regularly ventilate the room for a few days".

ESPAÑOL: "Después de montar este producto, es aconsejable ventilar la habitación frecuentemente, durante unos días".

ITALIANO: "Dopo avere montato il prodotto si consiglia di ventilare la stanza per alcuni giorni."

## FRANCAIS - SUISSE

### CONSEILS DE MONTAGE :

- 1 > BIEN ETUDIER LA NOTICE DE MONTAGE.
- 2 > REPEREZ LES PIÈCES CONSTITUANT VOTRE MEUBLE.
- 3 > REGROUPEZ ET CONTROLEZ LA QUINCAILLERIE.
- 4 > MUNISSEZ-VOUS DE L'OUTILLAGE NECESSAIRE.
- 5 > AMENAGEZ-VOUS UNE ZONE DE MONTAGE.
- 6 > PROCEDEZ AU MONTAGE.



**NE JAMAIS FORCER LES ASSEMBLAGES.  
RESSERREZ LES VIS APRES QUELQUES TEMPS D'USAGE.  
GARDER VOTRE NOTICE DE MONTAGE, SI UNE PIÈCE  
VENAIT A MANQUER, ELLE SERAIT LE PLUS CLAIR  
MOYEN DE COMMUNIQUER AVEC VOTRE MAGASIN.**

### CONSEILS D'ENTRETIEN :

- 1 > DÉPOUSSIÉREZ SOIGNEUSEMENT.
- 2 > UTILISEZ UN CHIFFON SEC.



**- NE JAMAIS UTILISER  
DE PRODUITS ABRASIFS:  
POUDRE, LAINE D'ACIER, SOLVANTS.  
- NE PAS MOUILLER**

	PAPIER DECOR	SURFACES STRATIFIÉES	SURFACES LAQUÉES	BOIS VERNIS	TEXTILE CUIR
EAU SAVONNEUSE (SAVON NEUTRE)	○	○	○	○	○
EAU ADDITIO NÉE		○	○		
ENTRETIEN SPÉCIFIQUE FABRICANT					○

## DEUTSCH - SCHWEIZ

### MONTAGE ANLEITUNG:

- 1 > DIE MONTAGEANLEITUNG SORGFÄLTIG DURCHLESEN.
- 2 > DIE EINZELTEILE DES MÖBELSTÜCKS ERMITTELN.
- 3 > DIE BESCHLÄGE ZUSAMMENLEGEN UND PRÜFEN.
- 4 > DAS NOTWENDIGE WERKZEUG ZURECHTLEGEN.
- 5 > EINEN MONTAGEBEREICH FREIMACHEN.
- 6 > DAS MÖBELSTÜCK ZUSAMMENBAUEN.



**NIEMALS DIE VERBINDUNGEN ZU STARK ANZIEHEN.  
DIE SCHRAUBEN NACH EINIGER ZEIT DES GEBRAUCHS  
ERNEUT FESTZIEHEN. DIE MONTAGEANLEITUNG  
GUT AUFBEWAHREN: SOLLTE EIN TEIL FEHLEN, IST SIE DAS  
BESTE VERSTÄNDIGUNGSMITTEL MIT IHREM GESCHÄFT.**

### PFLEGEHINWEISE :

- 1 > SORGFÄLTIG ENTSTAUBEN.
- 2 > VERWENDEN SIE EIN TROCKENES TUCH.



**- BENUTZEN SIE KEINE  
SCHEUERMITTEL WIE PULVER,  
STAHLWOLLE, LÖSUNGSMITTEL.  
- KEIN WASSER VERWENDEN.**

	DEKORPAPIER	OBERFLÄCHE LAMINAT	OBERFLÄCHE LACK	LACKIERTEM HOLZ	TEXUL LEDER
SEIFENLAUGE (NEUTRALSEIFE)	○	○	○	○	○
WASSER MIT HAUSHALTSRFINGER		○	○		
PRODUZENT SPEZIFISCHER UNTERHALT					○

## ITALIANO - SVIZZERA

### CONSIGLI DI MONTAGGIO

- 1 > STUDIARE BENE LE ISTRUZIONI DI MONTAGGIO.
- 2 > PRENDERE CONOSCENZA DEI PEZZI CHE COSTITUISCONO IL MOBILE.
- 3 > RAGGRUPPARE E CONTROLLARE LA FERRAMENTA.
- 4 > MUNIRSI DEGLI UTENSILI NECESSARI.
- 5 > PREPARARE UNA ZONA DI MONTAGGIO.
- 6 > PROCEDERE AL MONTAGGIO.



**NON FORZARE MAI GLI ASSEMBLAGGI  
RISTRINGERE LE VITI DOPO UN PERIODO D'USO  
CONSERVARE QUESTE ISTRUZIONI DI MONTAGGIO,  
SE UN PEZZO VENISSE A MANCARE SAREBBE IL MIGLIORE  
MEZZO DI COMUNICAZIONE CON IL RIVENDITORE**

### CONSIGLI PER LA MANUTENZIONE :

- 1 > SPOLVERATE ACCURATAMENLE.
- 2 > USARE UN PANNINO ASCIUTTO.



**- NON UTILIZZARE MAI PRODOTTI  
ABRASIVI: POLVERE,  
LANA DI ACCIAIO, SOLVENTI.  
- NON BAGNARE.**

	CARTA	SUPERFICIE STRATIFICATE	SUPERFICIE LACCATE	LACCATE EGNO VERNICIATO	TESSILE CUOIO
ACQUA CON SAPONE (SAPONE NEUTRO)	○	○	○	○	○
ACQUA CON DETERSIVO SAN MARC		○	○		
MANUTENZIONE SPECIFICA PRODUTTORE					○

## PORTUGUÊS

### CONSELHOS DE MONTAGEM:

- 1 > ESTUDE BEM AS INSTRUÇÕES DE MONTAGEM.
- 2 > REUNA AS PEÇAS QUE CONSTITUEM O SEU MÓVEL.
- 3 > REAGRUPE AS FERRAGENS.
- 4 > EQUIPE-SE COM AS FERRAMENTAS NECESSÁRIAS.
- 5 > PREPARE UMA ÁREA PARA A MONTAGEM.
- 6 > INICIE A MONTAGEM.



**NUNCA FORÇAR OS ENCAIXES.  
REAPERTAR OS PARAFUSOS APÓS UM TEMPO DE UTILIZAÇÃO.  
GUARDAR AS INSTRUÇÕES DE MONTAGEM.  
CASO FALTE ALGUMA PEÇA, O MAIS ACONSELHÁVEL  
É CONTATAR O REVENDEDOR.**

### CONSELHOS PARA A MANUTENÇÃO :

- 1 > ELIMINAR BEM O PÓ.
- 2 > USAR PANO SECO.



**- NUNCA UTILIZAR PRODUTOS  
ABRASIVOS: SAPONÁCEOS,  
LÃ DE AÇO, SOLVENTES.  
- NÃO MOLHAR .**

	ACABAMENTO IMITAÇÃO	SUPERFÍCIES ESTRATIFICADAS	SUPERFÍCIES LACADAS	MADEIRA ENVERNIZADA	TEXTEIS PELES
ÁGUA COM SABÃO (SABÃO NEUTRO)	○	○	○	○	○
ÁGUA COM DETERGENTE		○	○		
INSTRUÇÕES ESPECÍFICAS DO FABRICANTE					○

## ESPAÑOL

### CONSEJOS PARA EL MONTAJE:

- 1 > ESTUDIE ATENTAMENTE EL MANUAL DE MONTAJE.
- 2 > LOCALICE LAS PIEZAS QUE CONSTITUYEN SU MUEBLE.
- 3 > REUNA Y CONTROLE LOS TORNILLOS.
- 4 > EQUIPE-SE DE LAS HERRAMIENTAS NECESARIAS.
- 5 > PREPARE UNA ZONA DE MONTAJE.
- 6 > REALICE EL MONTAJE.



**NO FUERCE NUNCA EN LAS UNIONES. APRIETE LOS  
TORNILLOS DESPUES DE CIERTO TIEMPO DE UTILIZACION  
CONSERVE SU MANUAL DE MONTAJE,  
SI FALTARA UNA PIEZA, SERIA LA MANERA  
MAS FACIL DE COMUNICAR CON LA TIENDA.**

### CONSEJOS PARA EL MANTENIMIENTO:

- 1 > DESPOLVOREAR CULDADOSAMENTE.
- 2 > UTILICE UN PAÑO SECO.



**- NO USE NUNCA PRODUCTOS  
ABRASIVOS TALES COMO:  
POLVO DE LIMPIAR,  
LANA DE ACERO, SOLVENTES.  
- NO MOJAR.**

	PAPEL DE DECORACION	SUPERFICIE ESTRATIFICADAS	SUPERFICIE MAQUEADAS	MADERA BARNIZADA	TEXULL CUERO
AGUA Y JABON (JABON NEUTRO)	○	○	○	○	○
AGUA COM DETERGENTE		○	○		
MANTENIMIENTO ESPECIFICO DEL FABRICANTE					○

## HRVATSKA

### UPUTE ZA MONTAŽU:

- 1 > PAŽLJIVO PROČITAJTE UPUTE ZA MONTAŽU.
- 2 > PRIPREMITE SVE DIJELOVE NAMJEŠTAJA.
- 3 > PRIKUPITE I PROVJERITE OKOVE ZA MONTAŽU.
- 4 > PRIPREMITE POTREBAN ALAT.
- 5 > PRIPREMITE PROSTOR ZA MONTAŽU.
- 6 > POČNITE MONTIRATI.



**NEMOJTE UPOTREBLJAVATI SILU PRILIKOM SKLAPANJA  
NAKON NEKOG VREMENA PONOVRNO PRITEGNITE VIJKE  
ČUVAJTE UPUTE ZA MONTAŽU  
U SLUČAJU NEDOSTATKA NEKOG DIJELA NAJBOLJE ĆE BITI DA  
DA KONTAKIRATE PRODAJNO MJESTO.**

### UPUTE ZA ODRŽAVANJE :

- 1 > PAŽLJIVO OBRISATI PRAŠINU.
- 2 > KORISTITE SUHU KRPU.



**- ZABRANJENA JE UPOTREBA  
KEMIKALIJA ILI BILO KAKVIH  
POMOĆNIH SREDSTAVA ZA RIBANJE  
JAKIH SREDSTAV ZA ČIŠĆENJE ILI  
ČELIČNE VUNE  
-NE MOKRA.**

	PAPIR	LAMINAT	LAK	DRVO	TEKSTIL/ KOŽA
OTPINA SAPUNA	○	○	○	○	○
OTPINA DETERDŽENTA		○	○		
NAMJENSKA SREDSTVA					○

## TÜRÇE

### MONTAJ TALIMATLARI:

- 1 > MONTAJ TANITIM YAZISINI DIKKATLİCE OKUYUNUZ.
- 2 > MOBİLYANIZI OLUŞTURAN PARÇALARI İŞARETLEYİNİZ.
- 3 > HIRDAVATLA İLGİLİ PARÇALARI BİR ARAYA TOPLAYIP; KONTROL EDİNİZ.
- 4 > GEREKEN ARAÇ VE GEREÇİ TEDARİK EDİNİZ.
- 5 > (KENDİNİZE) BİR MONTAJ ALANI EDİNİNİZ.
- 6 > MONTE ETMEYE BAŞLAYINIZ.



**MONTAJLARI ZORLAMAYINIZ.**  
BİRKAÇ KULLANIMDAN SONRA VIDALARI SIKIŞTIRINIZ.  
BİR PARÇANIN KAYBOLMASI DURUMUNDA MAGAZANIZLADAKİ  
KOLAY İLETİŞİME GEÇEBİLMENİZ İÇİN MONTAJ KULLANIM  
TALIMATINI SAKLAYINIZ.

### BAKIM TALIMATLARI:

- 1 > TOZUNU DIKKATLİCE ALINIZ.
- 2 > YUMUŞAK BİR BEZİ TEMİZ SU VE AZ MİKTARDA SABUNLA (DETERJAN) NEMLENDİRİNİZ.



**ASLA AŞINDIRICI ÜRÜNLER  
KULLANMAYINIZ : ÇELİK YÜNÜ,  
SOLVENT...  
BOL SUYLA YIKAMAYINIZ.**

	BÖS KAGIDI	KATMAN YÜZEY	LAK YÜZEY	CELMI TANIT	TEKSTİL DERİ
SABUNLU SU (NOTU SABUN)	<input type="radio"/>	<input type="radio"/>	<input type="radio"/>	<input type="radio"/>	<input type="radio"/>
DETERJAN KATLI SU		<input type="radio"/>	<input type="radio"/>		
ÖZELİNE ÖZGÜ BAKIM					<input type="radio"/>

## ENGLISH

### ASSEMBLY ADVICE :

- 1 > CAREFULLY READ THE ASSEMBLY INSTRUCTION.
- 2 > IDENTIFY THE COMPONENTS OF THE FURNITURE.
- 3 > GROUP AND CHECK THE HARDWARE.
- 4 > USE THE REQUIRED TOOLS.
- 5 > CREATE AN ASSEMBLY ZONE.
- 6 > MAKE THE ASSEMBLY.



**NEVER FORCE THE CONNECTIONS.**  
RE-TIGHTEN THE SCREWS AFTER FEW DAYS.  
PLEASE RETAIN THE AI LEAFLET FOR FUTURE REFERENCE,  
THE AI CONTAINS INFORMATION WHEN CLAIMING  
FOR MISSING PARTS.

### CLEANING ADVICE:

- 1 > CAREFULLY REMOVE THE DUST.
- 2 > USE A SOFT, CLEAN DAMP CLOTH WITH SOAPY WATER.



**NEVER USE ABRASIVE PRODUCTS  
OR SOLVENTS.  
DO NOT APPLY EXCESSIVE PRESSURE  
WHEN USING THE DAMP CLOTH.**

	PAPER DECOR	LAMINATED SURFACES	LACQUERED SURFACE	VARNISHED WOOD	LEATHER TEXTILE
SOAPY WATER (NEUTRAL SOAP)	<input type="radio"/>	<input type="radio"/>	<input type="radio"/>	<input type="radio"/>	<input type="radio"/>
WATER WITH DETERGENT		<input type="radio"/>	<input type="radio"/>		
SPECIFIC SUPPLIER CLEANING					<input type="radio"/>



FR

**Donnez ou recyclez  
vos meubles.**



Association

OU



Magasin

OU



Déchèterie



**LE TRI  
+ FACILE**

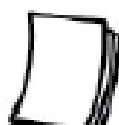

**BAC  
DE TRI**