

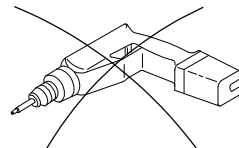

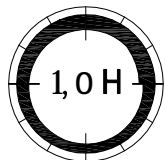

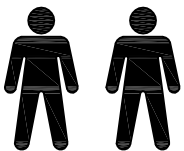

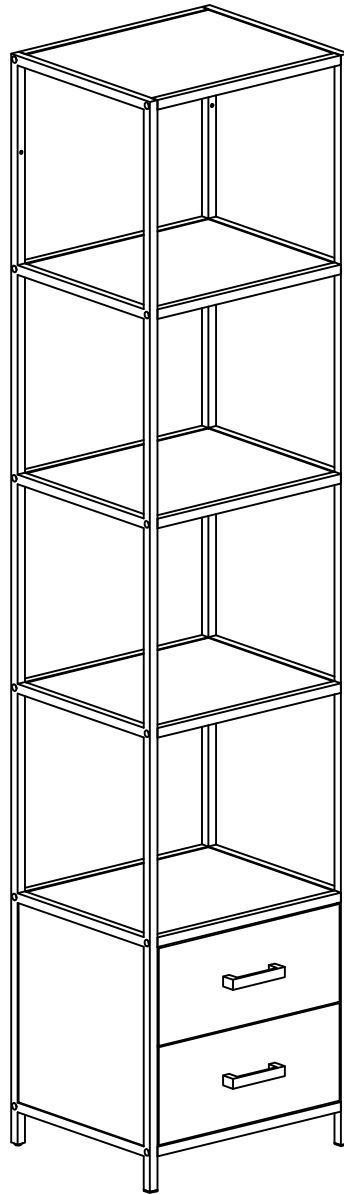

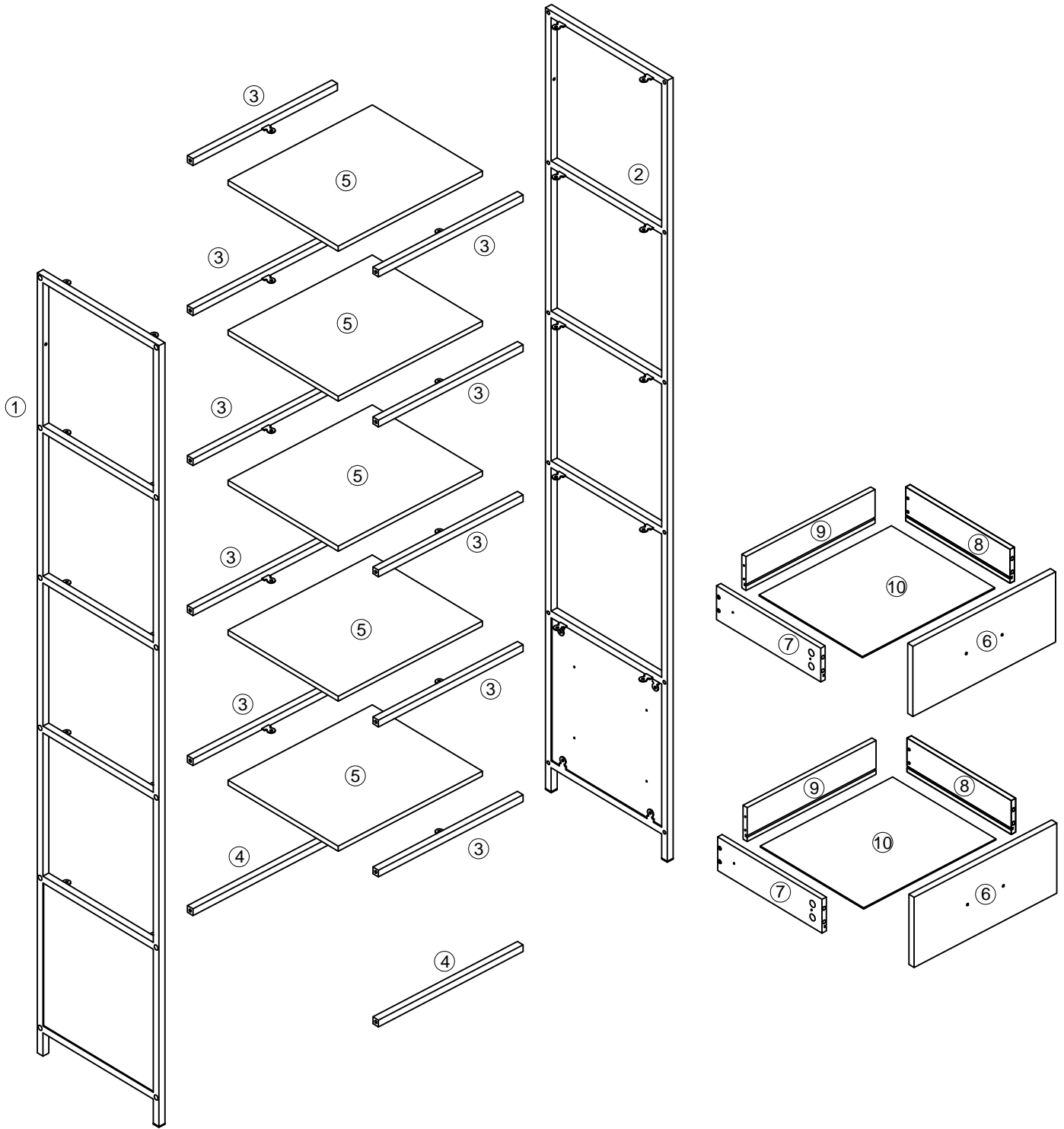
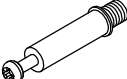

# Seaford





			✓			
①	1	1850x350x42		⑦	2	300x80x12
②	1	1850x350x42		⑧	2	300x80x12
③	10	388x42x16		⑨	2	346x80x12
④	2	388x16x16		⑩	2	355x297x2.75
⑤	5	387x316x12				
⑥	2	383x166x15				

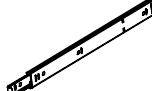

<p>A x 8</p>  <p>6.3×35mm</p>	<p>B x 8</p>  <p>Ø15×10mm</p>	<p>C x 30</p>  <p>M4×12mm</p>	<p>D x 16</p>  <p>3.5×12mm</p>
<p>E x 8</p>  <p>M4×35mm</p>	<p>F x 24</p>  <p>M6×15mm</p>	<p>G x 4</p>  <p>4×20mm</p>	<p>H x 2</p>  <p>L117mm</p>
<p>J x 1</p>  <p>4mm</p>	<p>K x 1</p>  <p>Ø16mm</p>	<p>L x 4</p>  <p>L300mm</p>	



# 3

F x 24	J x 1
	
M6×15mm	4mm

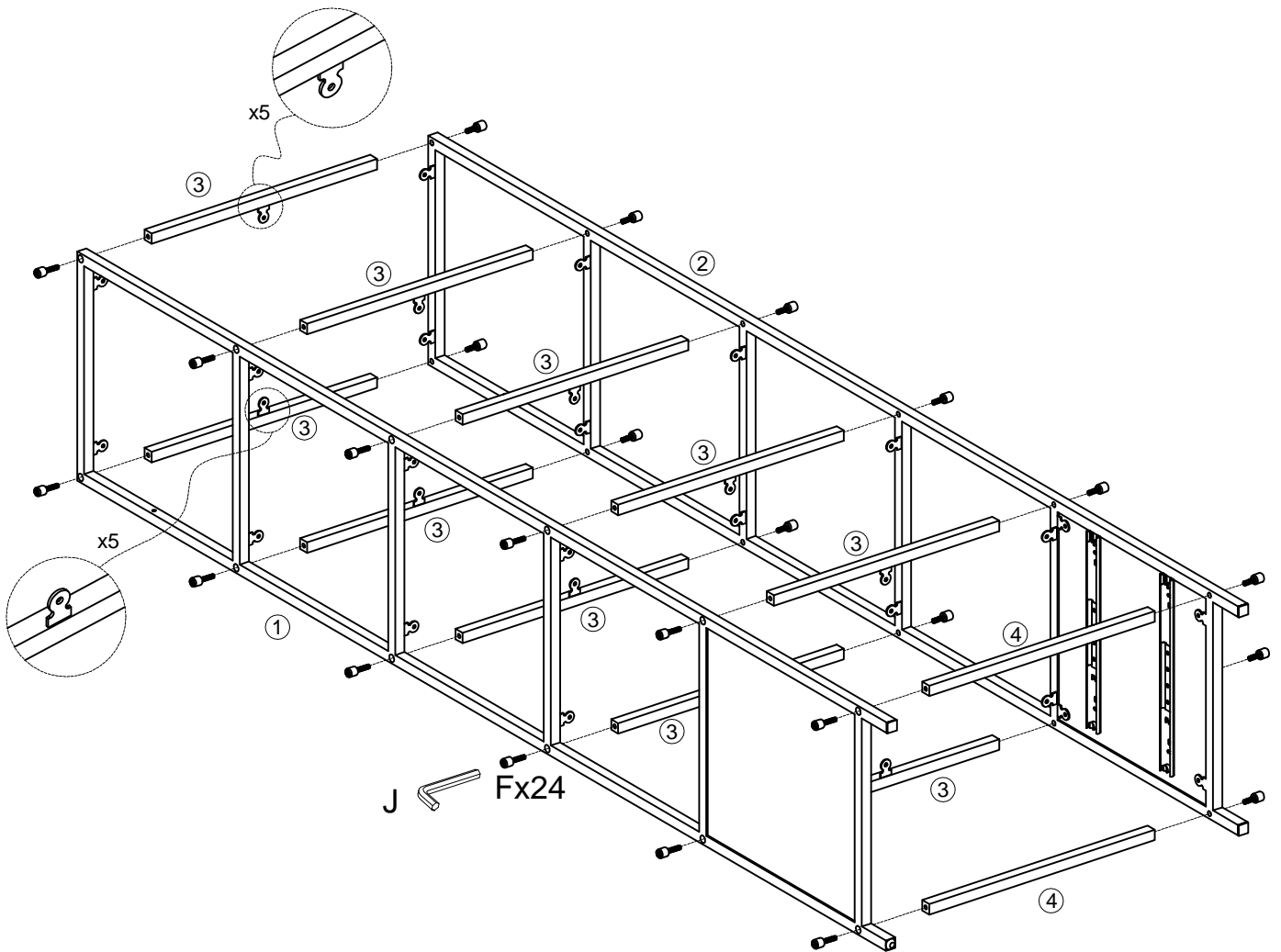
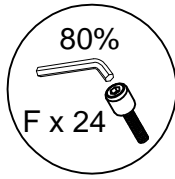

# 4





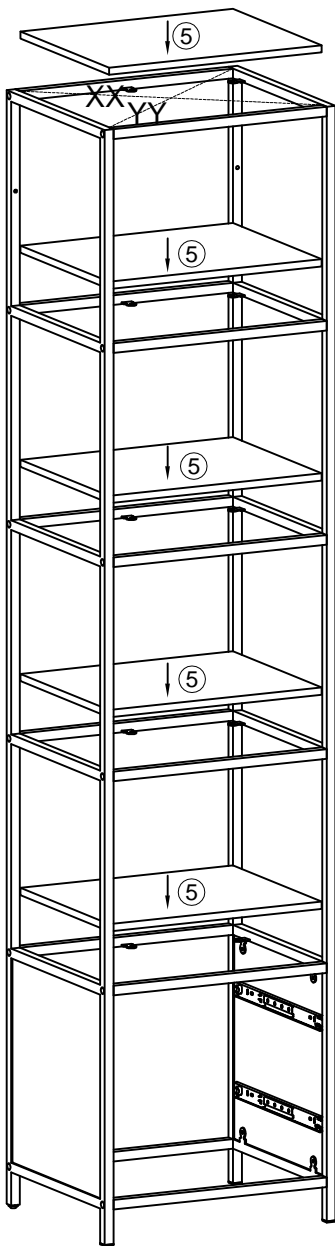

⚠ XX=YY

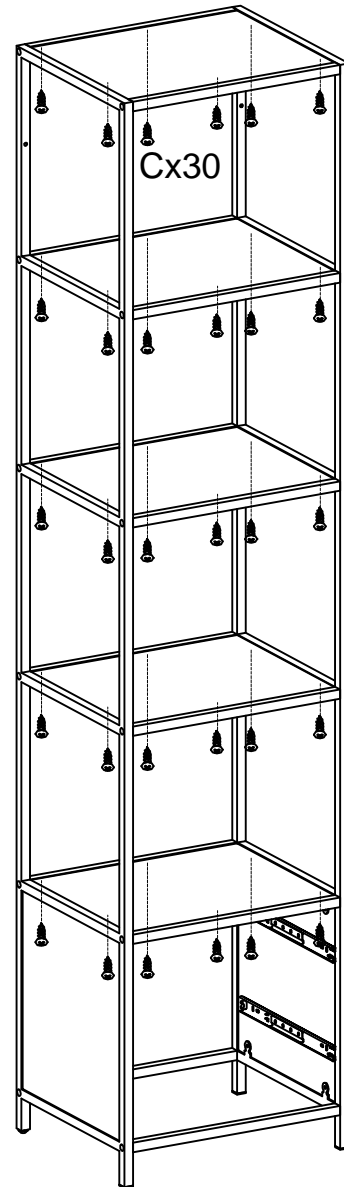
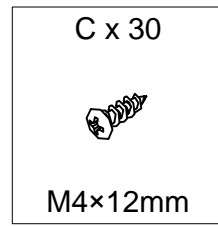

# 5

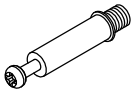

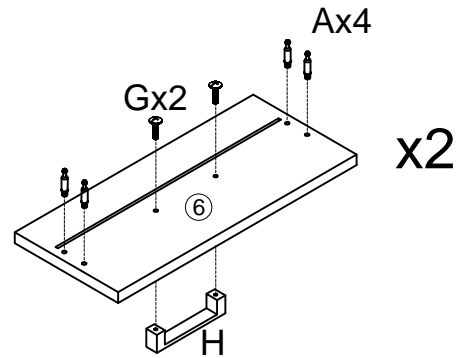
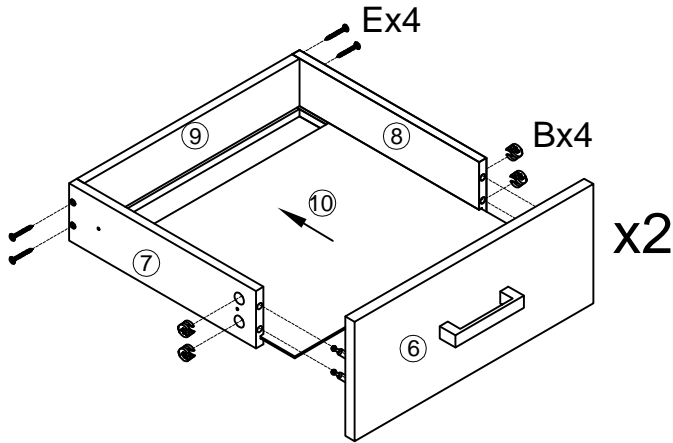

# 6

A x 8  6.3x35mm	B x 8  Ø15x10mm	G x 4  4x20mm	H x 2  L117mm	E x 8  M4x35mm
--	--	--	---	---



# 7

D x 8  3.5x12mm	L2 x 4  L300mm
--	---

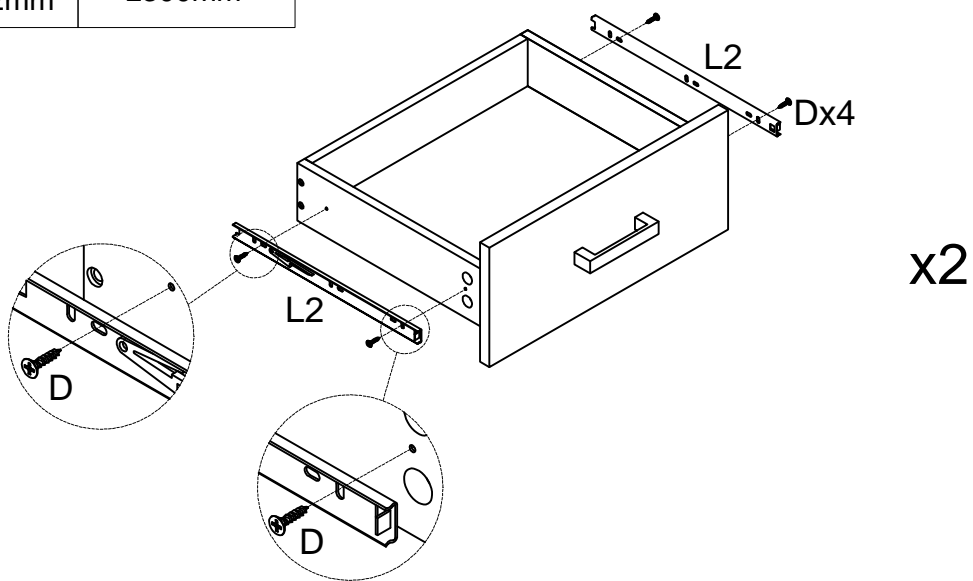

8

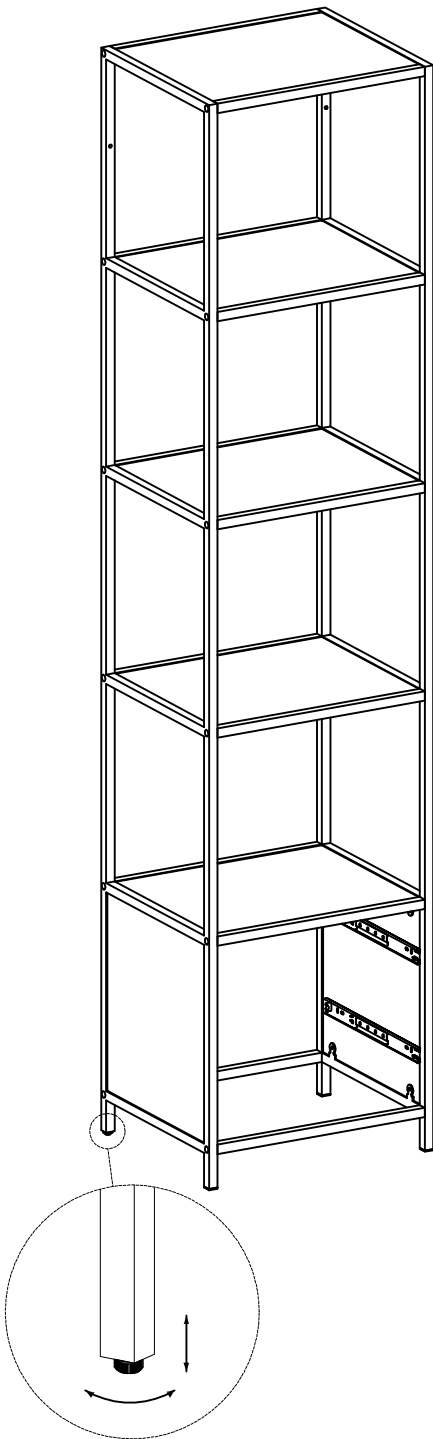

9

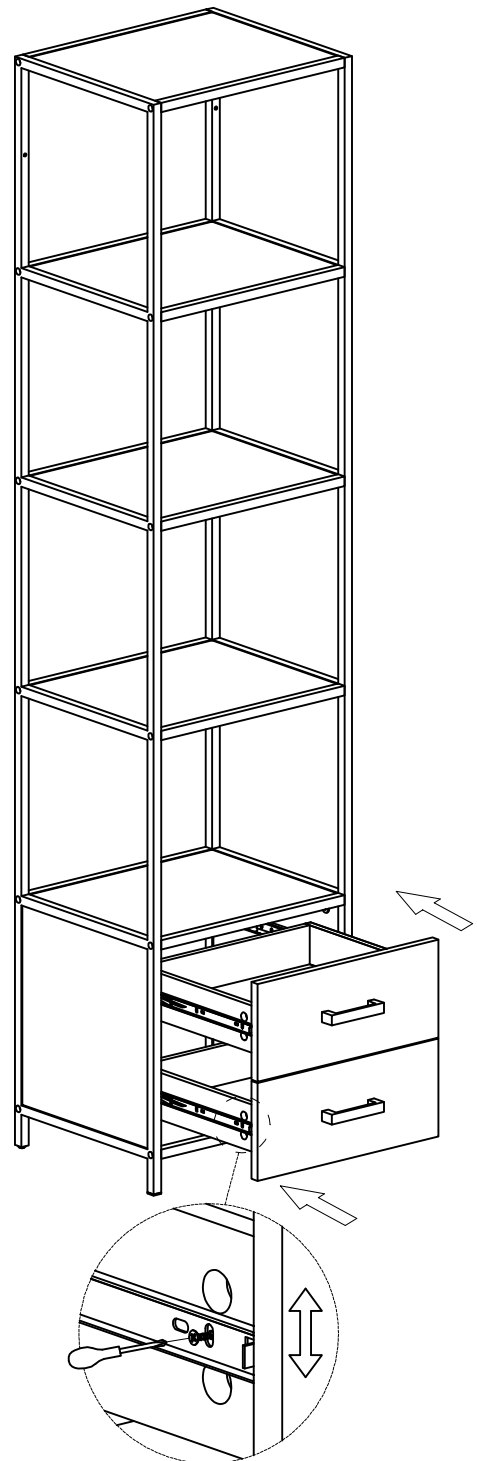



# 10

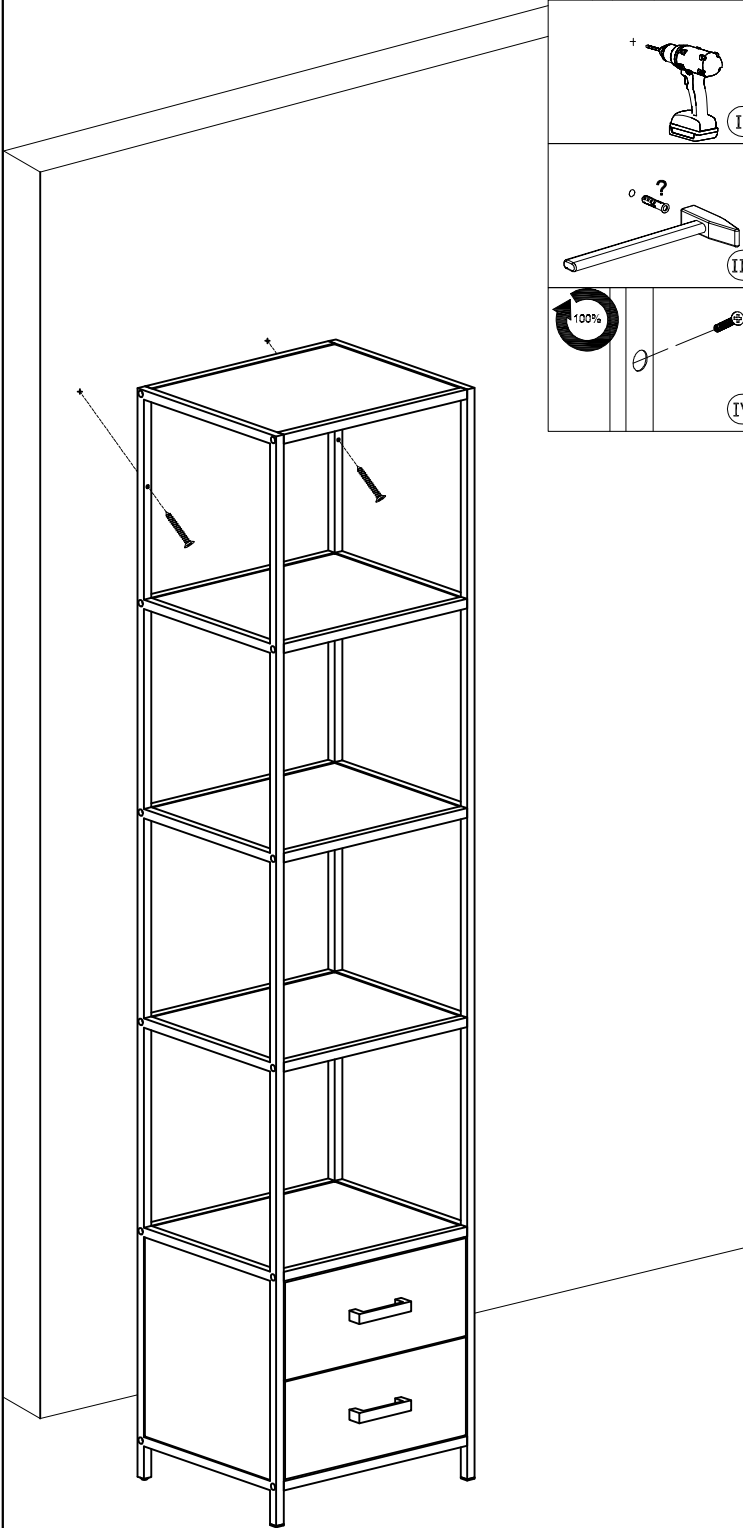
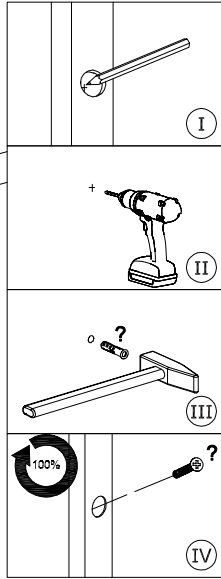

# 11

