

VUELTA PENDANT LAMP

ASSEMBLY MANUAL

fermliving.com

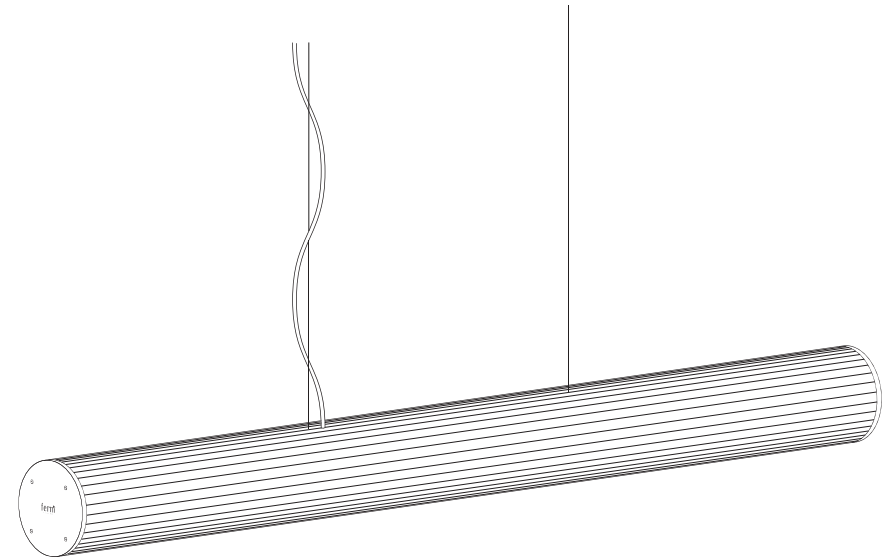

ferm
L I V I N G

TECHNICAL SPECIFICATIONS

VUELTA PENDANT 100

Rated Power:	30w
Lumen output at maximum:	2400lm
CCT:	3000k
CRI:	>90
Rated Voltage:	230V
Frequency:	50Hz
Certification:	CE/LVD/EMC/ROHS
Standard:	Dali implementation following EN62386-102 standard
Gift box Dimension:	1100x181x174mm
Cable lenght:	6m
Electrical wire lenght:	5m

VUELTA PENDANT 60

Rated Power:	20w
Lumen output at maximum:	1600lm
CCT:	3000k
CRI:	>90
Rated Voltage:	230V
Frequency:	50Hz
Certification:	CE/LVD/EMC/ROHS
Standard:	Dali implementation following EN62386-102 standard
Gift box Dimension:	700x181x174mm
Cable lenght:	6m
Electrical wire lenght:	5m

BOX CONTENTS

1x
Lamp
(100 or 60)

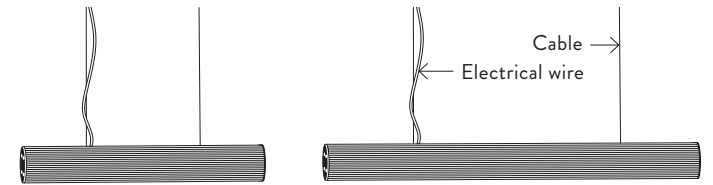

x1
Remote control

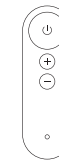

1x
Glove



2x
Cable holder



2x
Raw plugs Ø8mm
(not suitable for drywall)



2x
Screws

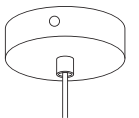

1x
Canopy
(arrives disassembled)

NEEDED TOOLS

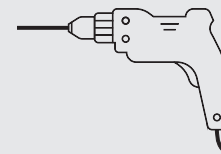

Electrical drill

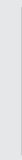

Pencil

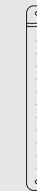

Ruler



Screwdriver
(Philips/Cross Slot)



Spirit level



Cable cutter

ASSEMBLY PROCESS

1.

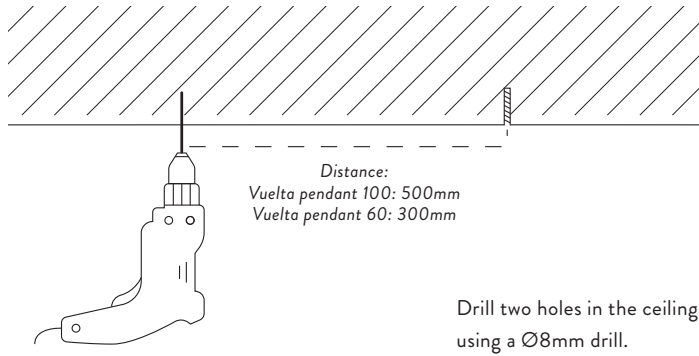

2.

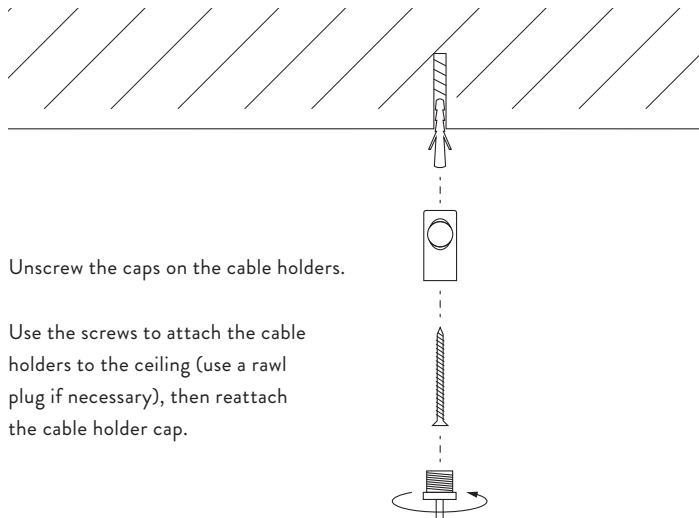

ASSEMBLY PROCESS

3.

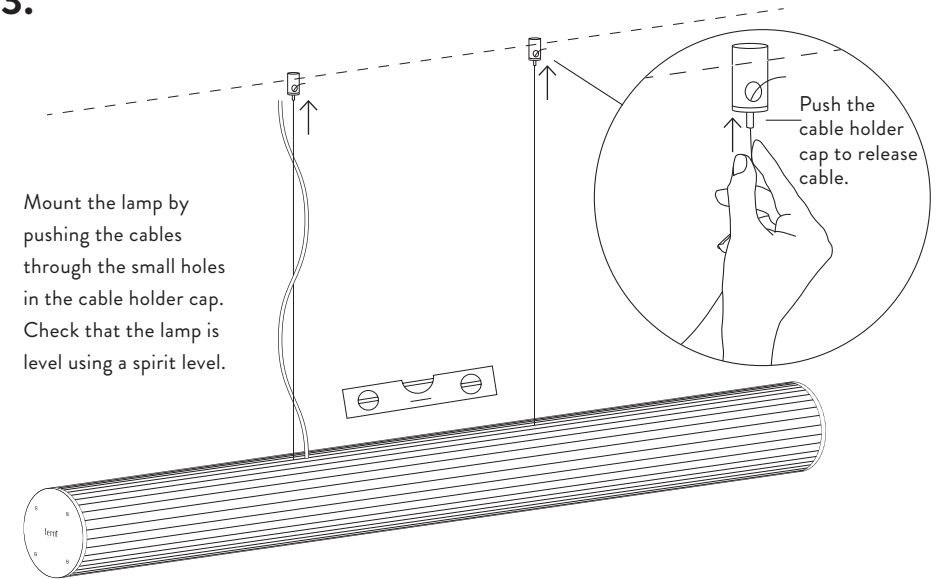

4.

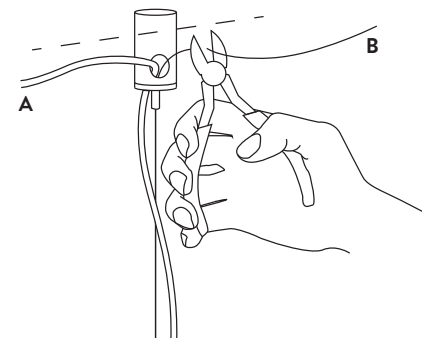

A. Route the electrical wire through the large holes in the cable holders.

B. Cut the cable to the desired length.
NOTE: Cables cannot be replaced, so only cut when you are sure you have achieved desired length.

ELECTRICAL INSTALLATION

Turn your power off during installation

5. Option A

NO DALI
CONNECTION

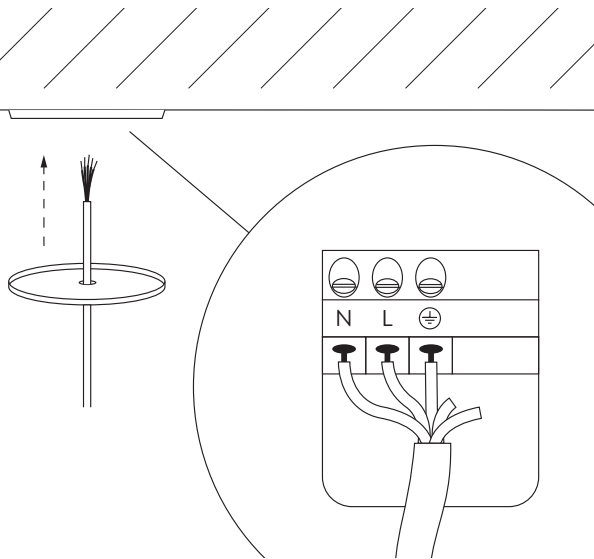

Connect the wires as shown here.

N: Blue wire

L: Brown wire

Ground icon: Green-yellow wire

5. Option B

DALI
CONNECTION

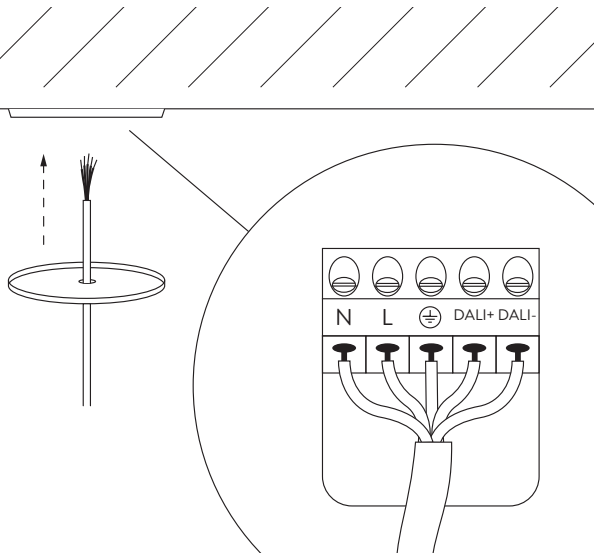

Connect the wires in the
ceiling socket as shown here.

N: Blue wire

L: Brown wire

Ground icon: Green-yellow wire

Dali+: Red wire

Dali-: Black wire

CANOPY INSTALLATION

Optional

6.

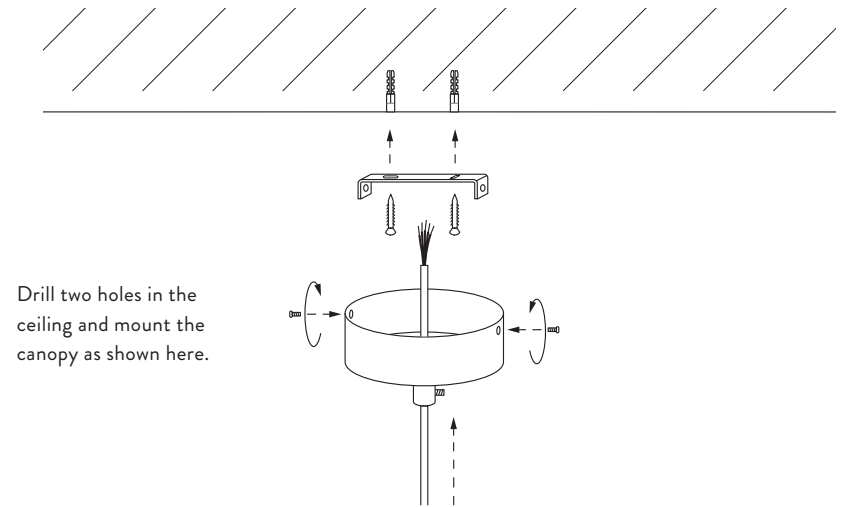

Drill two holes in the
ceiling and mount the
canopy as shown here.

HOW TO USE THE REMOTE CONTROL

7.

On/Off. Turns lamp on at maximum brightness / brightness level will be saved when turning off lamp

⊕ Increase light intensity / Turn the light on at saved brightness level

⊖ Decrease light intensity

Please note: If you use the wall switch to turn the lamp on and off, the lamp will return to the last saved brightness level. If the pendant is connected to a Dali bus, the remote is automatically deactivated.

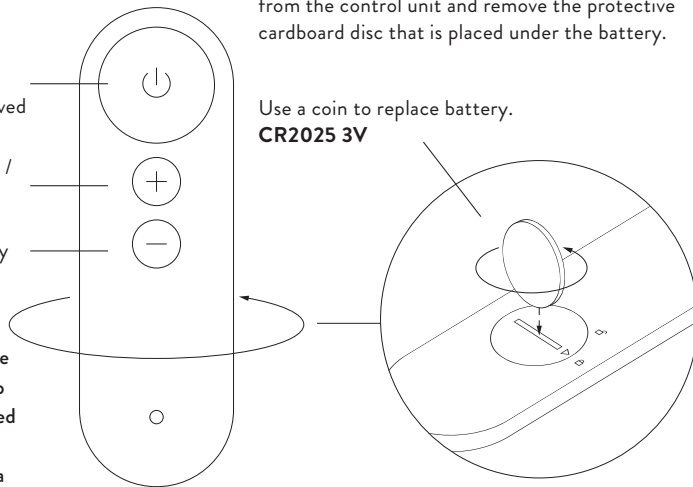

Before using the remote, please remove the battery from the control unit and remove the protective cardboard disc that is placed under the battery.

Use a coin to replace battery.
CR2025 3V

REMOTE CONTROL PAIRING

This pairing operation is not required unless you want to control multiple lamps (max 3 lamps) with the same remote control, or you need to reset your remote.

How to Pair:

1. Turn off the lamp's power at its electrical power supply.
2. Turn it on again. In the first 10 seconds, push the following sequence of buttons: on/off, +, -. Once the pairing has been done successfully, the lamp will flicker 3 times.

