

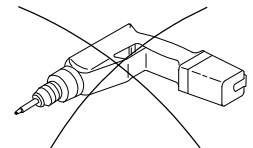

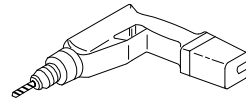

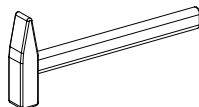

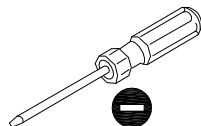

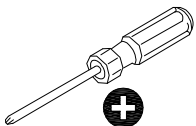
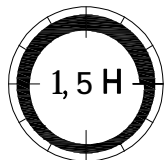
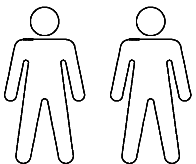
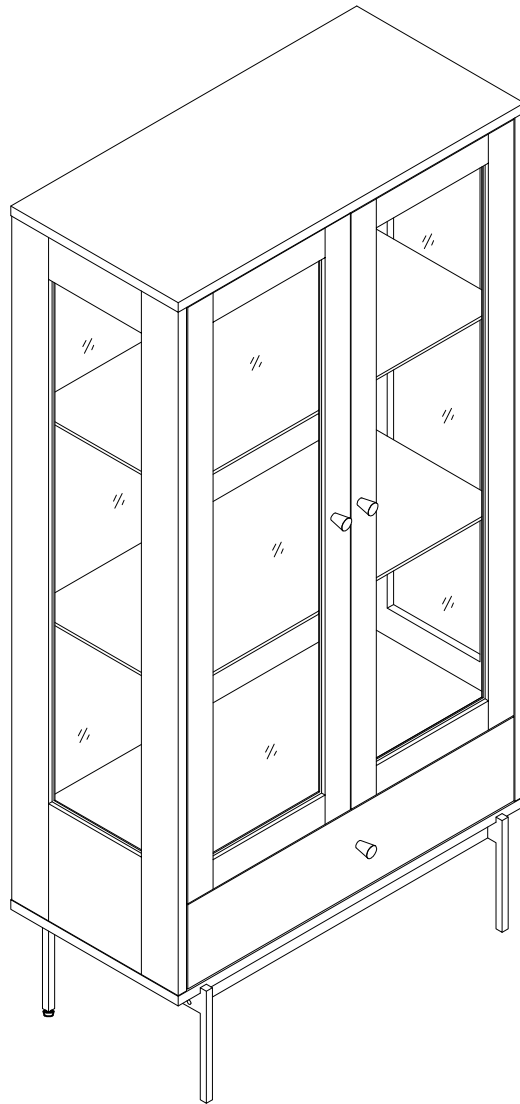
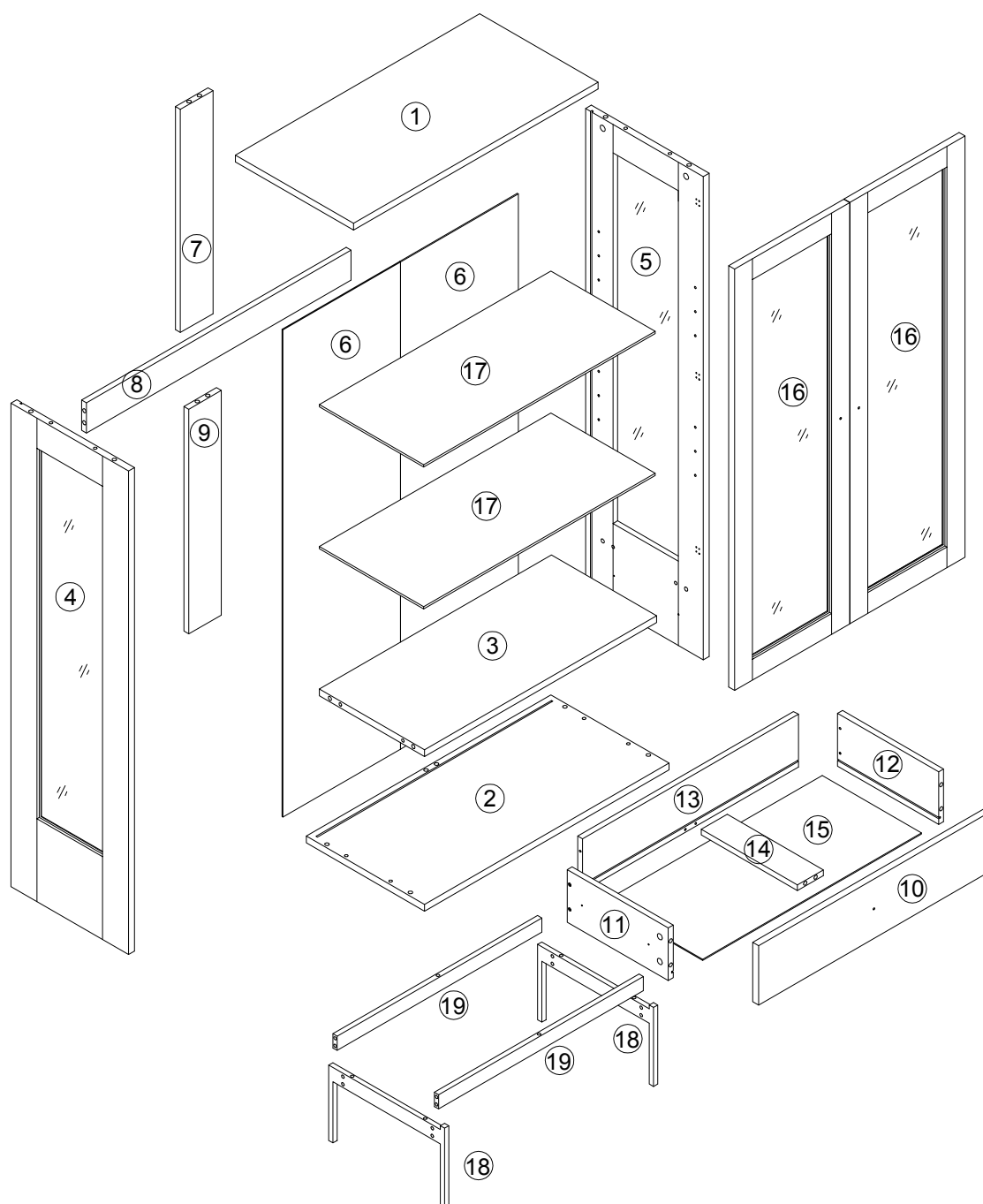

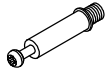









Angus

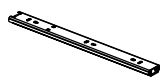

06/05/2021

			✓			
①	1	750x363x18		⑪	1	302x140x15
②	1	750x363x18		⑫	1	302x140x15
③	1	712x323x18		⑬	1	662x140x15
④	1	1280x362x18		⑭	1	287x80x15
⑤	1	1280x362x18		⑮	1	670x296x2.75
⑥	2	1291x361x2.75		⑯	2	1113x352x18
⑦	1	600x80x15		⑰	2	710x320x6
⑧	1	713x80x15		⑱	2	355x210x13
⑨	1	600x80x15				
⑩	1	707x158x18				



<p>A x 24</p>  <p>6.3×45mm</p>	<p>B x 24</p>  <p>Ø15×12mm</p>	<p>C x 12</p>  <p>Ø8×30mm</p>	<p>D x 4</p>  <p>Ø18</p>	<p>E x 2</p>  <p>L=100mm</p>
<p>F x 53</p>  <p>3.5×14mm</p>	<p>G x 3</p>  <p>4×22mm</p>	<p>H x 3</p>  <p>Ø20×20mm</p>	<p>J x 6</p>  <p>7×48mm</p>	<p>K x 8</p>  <p>M6×30mm</p>
<p>L x 6</p>  <p>M6×48mm</p>	<p>M x 6</p>  <p>4×35mm</p>	<p>N x 8</p>  <p>Ø5×20mm</p>	<p>P x 6</p>  <p>FK17</p>	<p>Q x 2</p>  <p>L=300mm</p>
<p>R x 6</p>  <p>9×9×14mm</p>	<p>S x 1</p>  <p>10×10×30mm</p>	<p>T x 8</p>  <p>Ø20mm</p>	<p>U x 1</p>  <p>4mm</p>	<p>V x 2</p>  <p>Ø13mm</p>

1

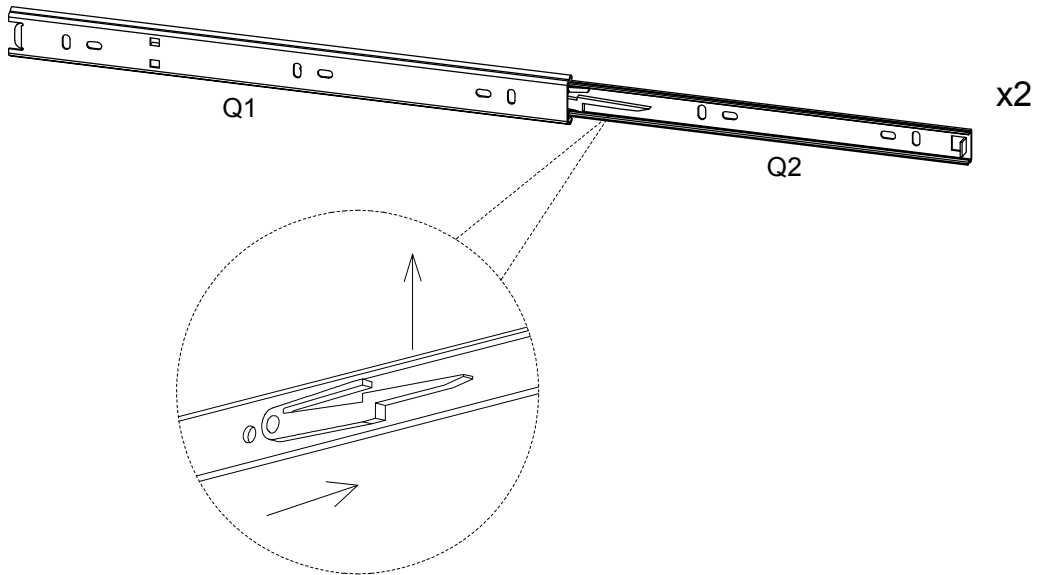
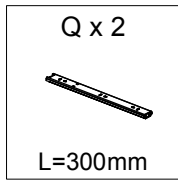

2

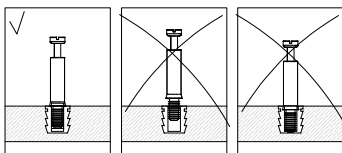
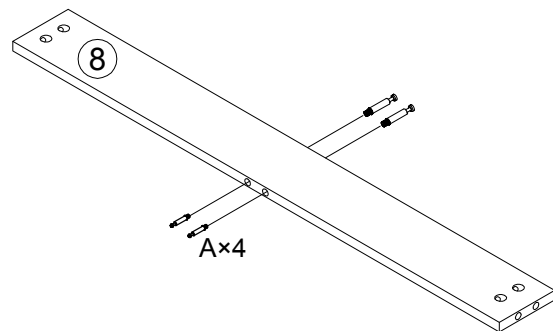
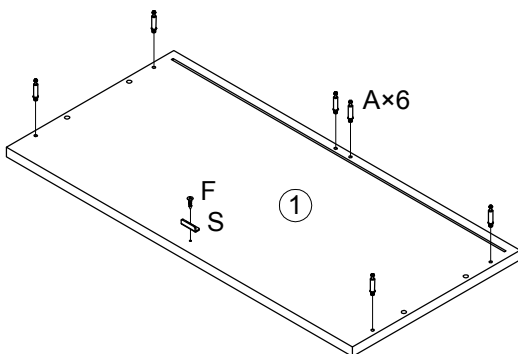
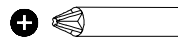
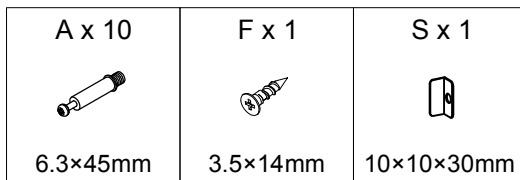

3





B x 4

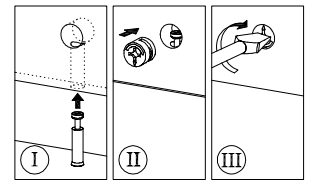
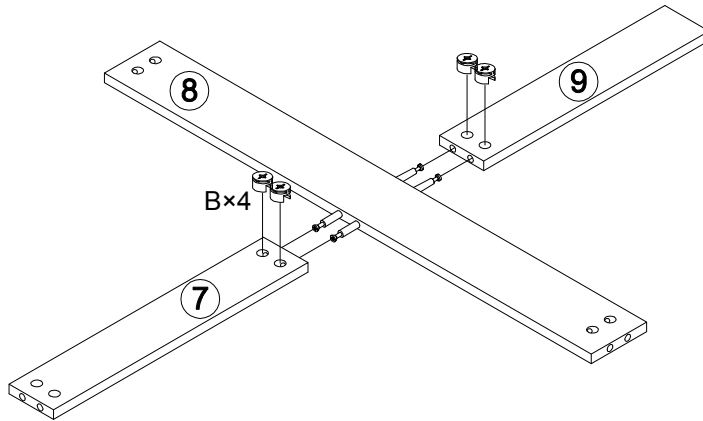
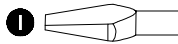

Ø15x12mm



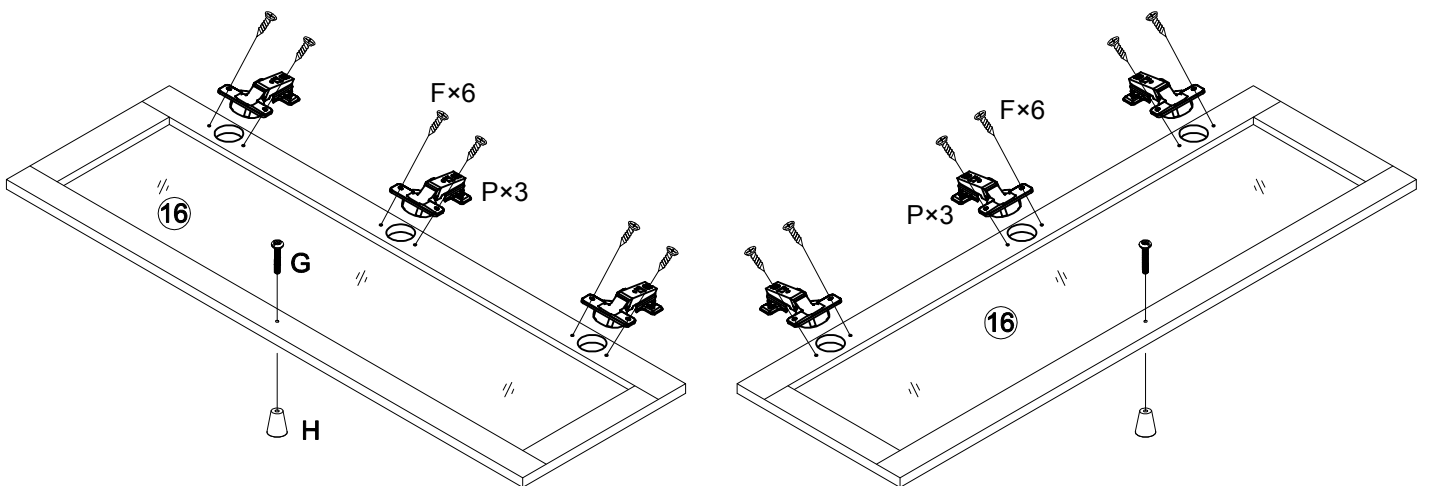
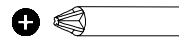

4

F x 12	G x 2	H x 2	P x 6
			
3.5x14mm	4x22mm	Ø20x20mm	FK17



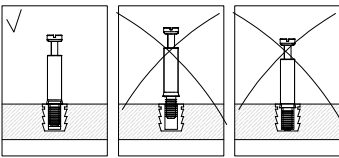
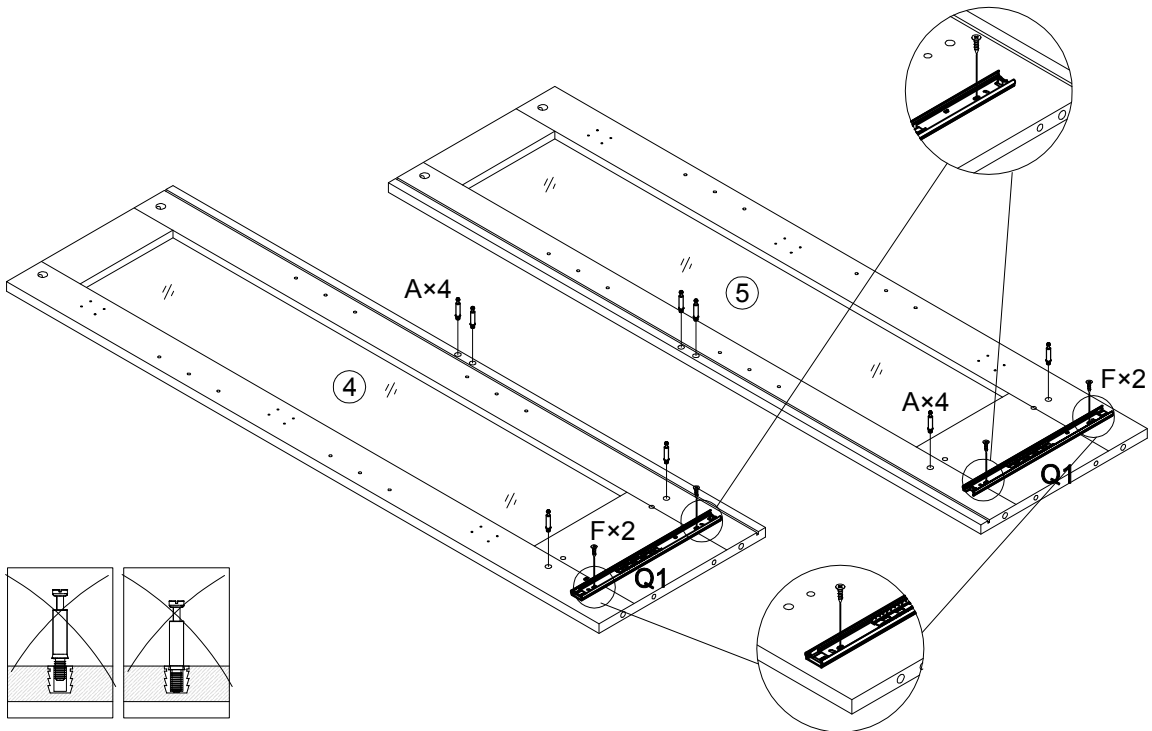
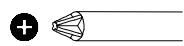

5

A x 8  6.3x45mm	F x 4  3.5x14mm	Q1 x 2  L=300mm
--	--	--



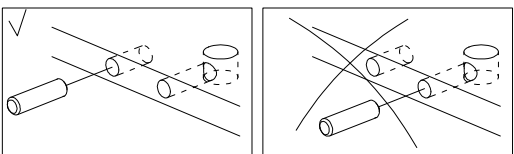
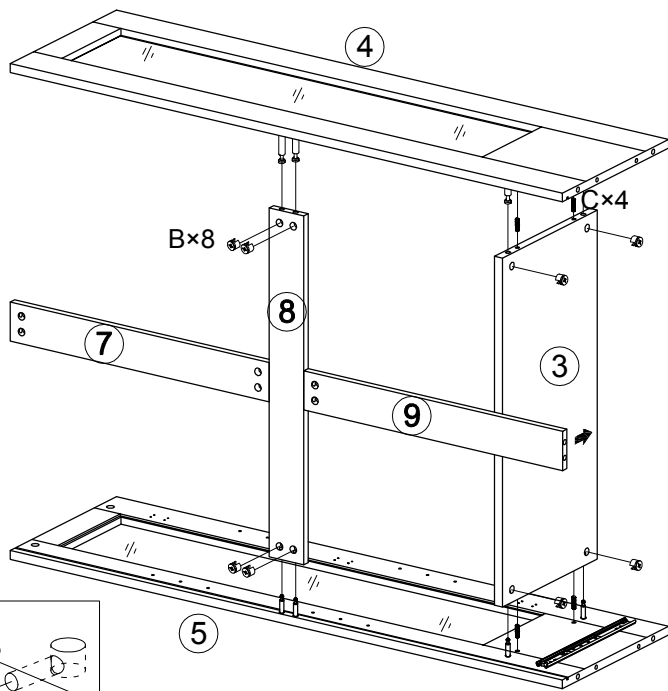
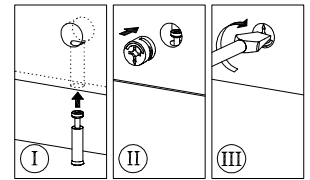
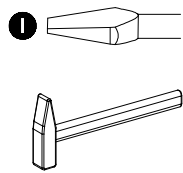

6

B x 8  Ø15x12mm	C x 4  Ø8x30mm
--	---



7

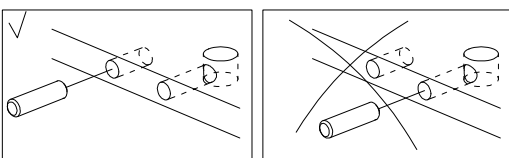
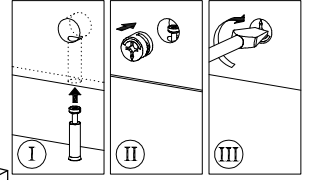
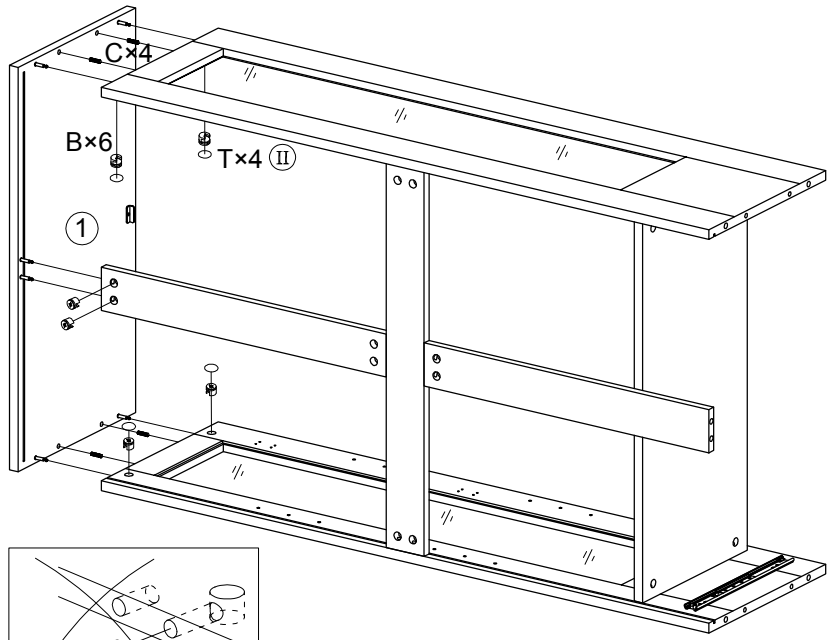
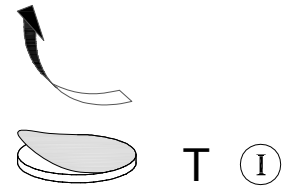
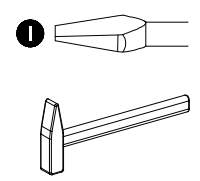

B x 6  Ø15x12mm	C x 4  Ø8x30mm	T x 4  Ø20mm
---	--	--

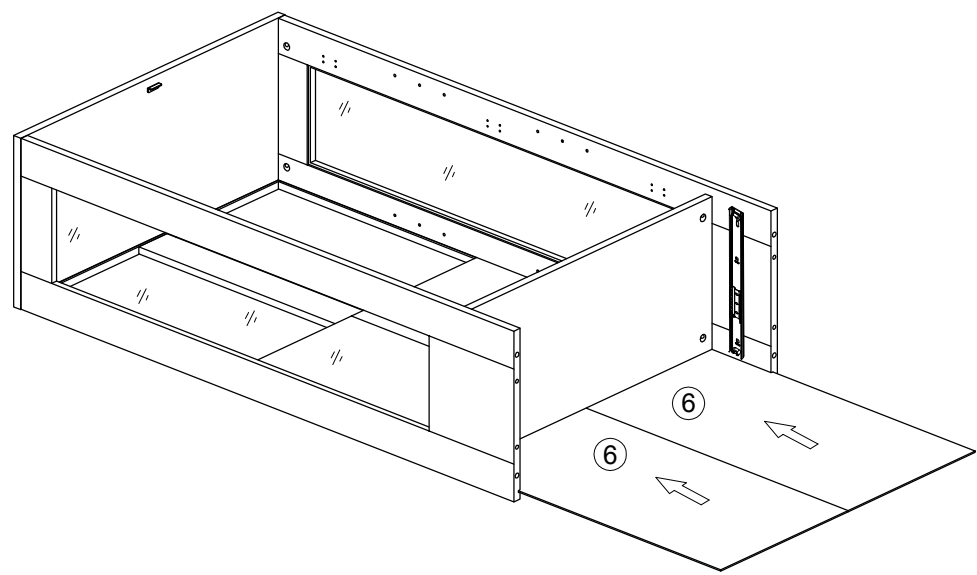

8



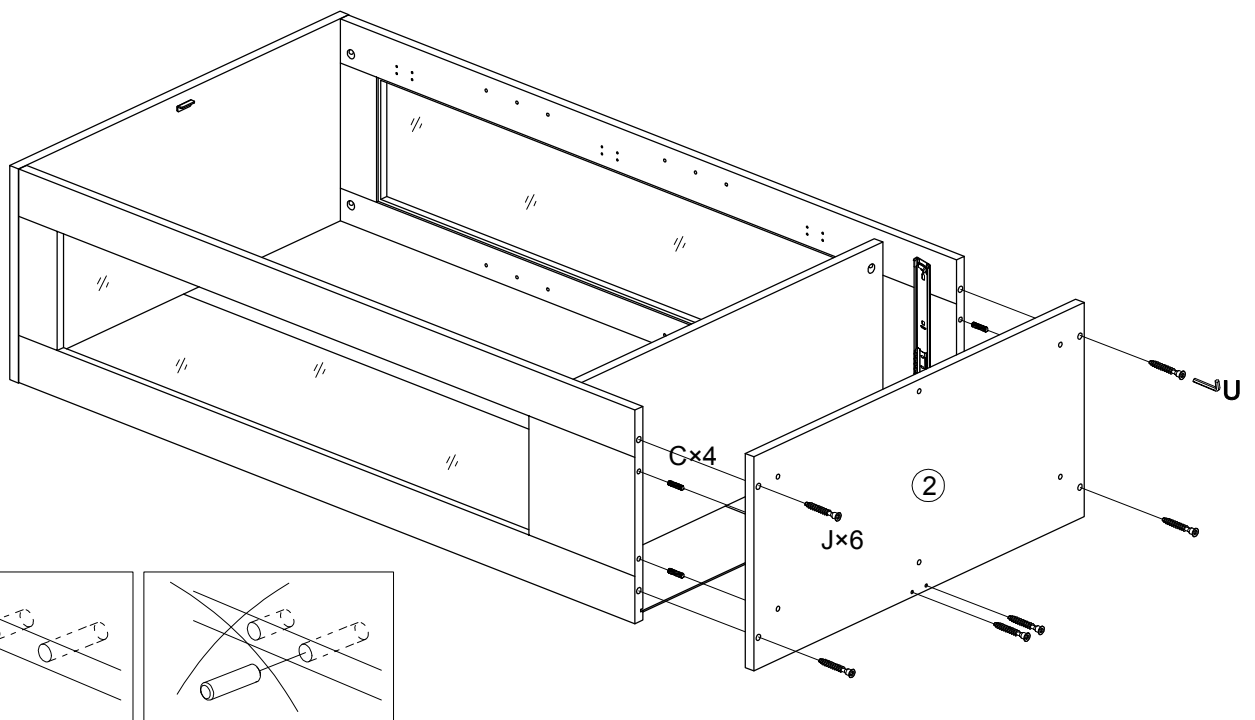

9

C x 4  Ø8x30mm	U x 1  4mm	J x 6  7x48mm
---	---	--



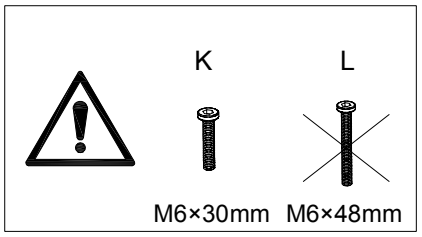
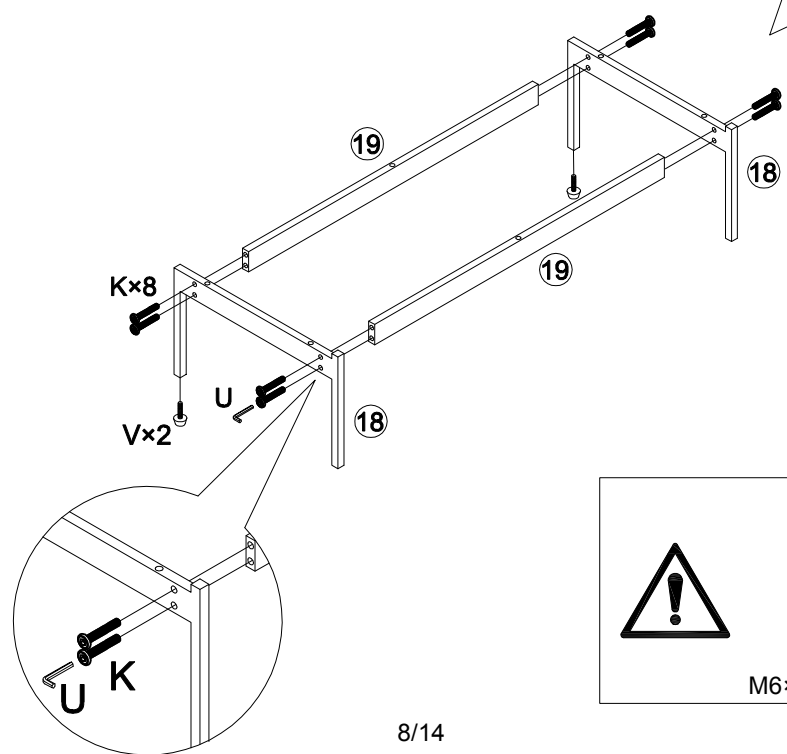
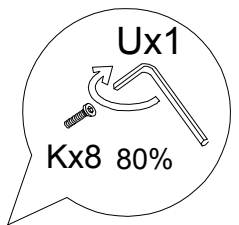

10

K x 8  M6x30mm	U x 1  4mm	V x 2  Ø13mm
---	---	---







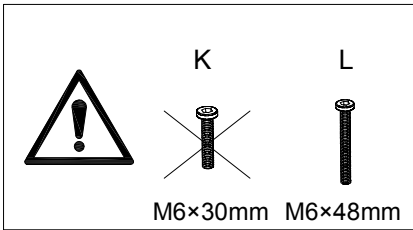
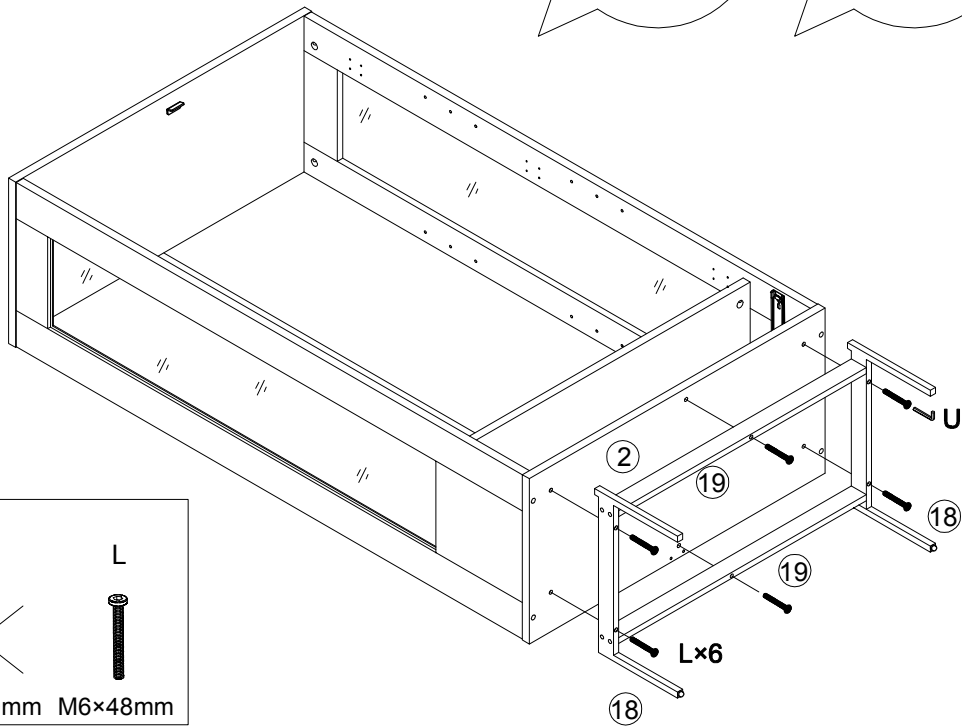
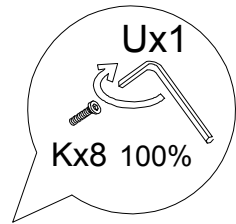
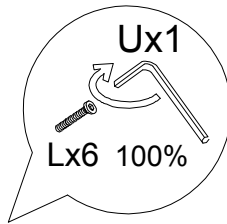

11

L x 6  M6x48mm	U x 1  4mm
---	---



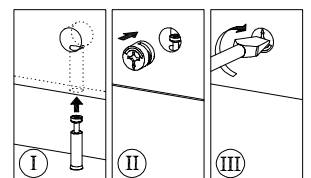
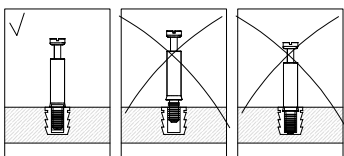
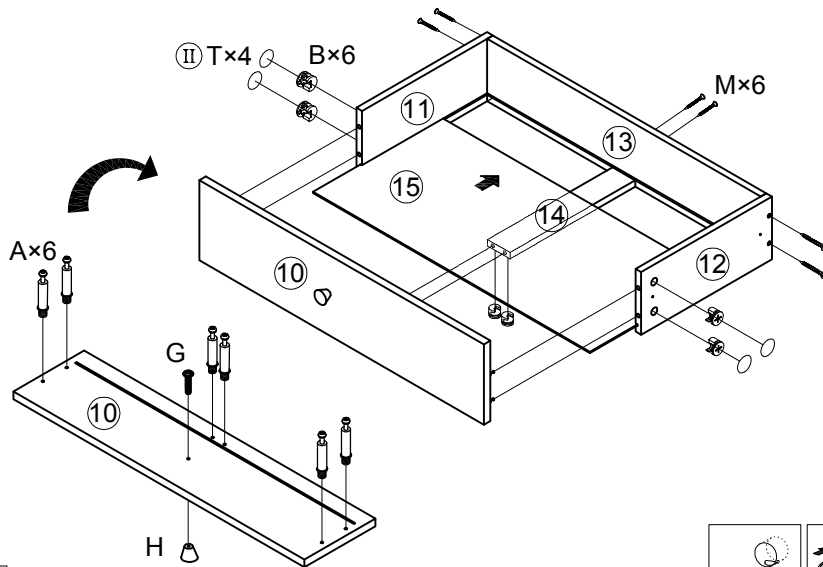
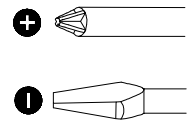

12

A x 6  6.3x45mm	B x 6  Ø15x12mm	G x 1  4x22mm	H x 1  Ø20x20mm	M x 6  4x35mm	T x 4  Ø20mm
--	--	--	--	---	---



13

F x 4  3.5x14mm	Q2 x 2  L=300mm
--	--

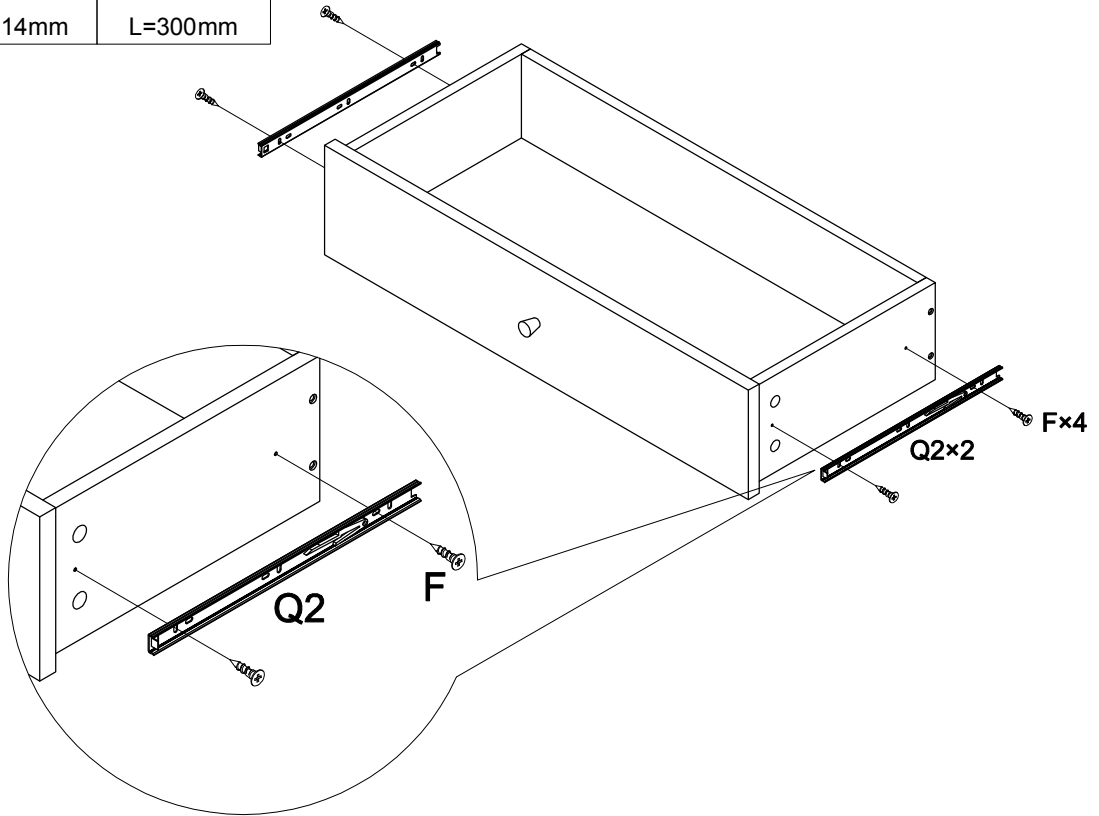
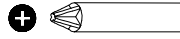



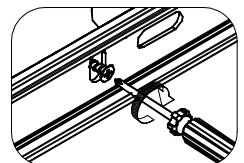
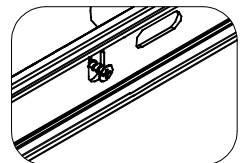
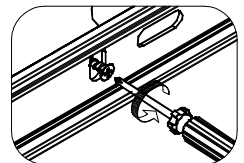
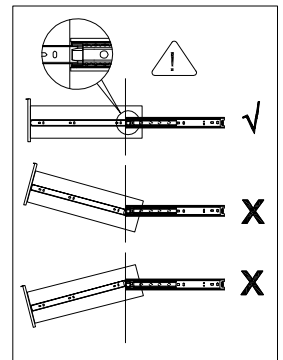
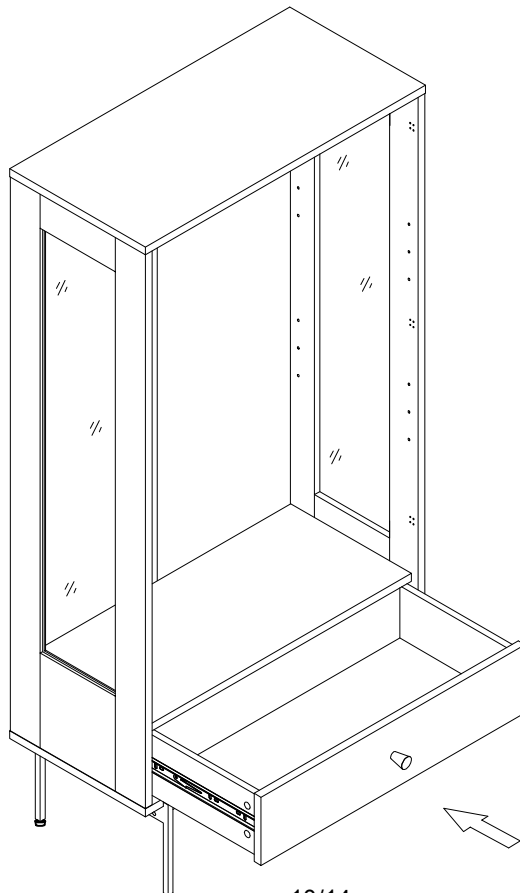

14

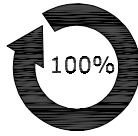
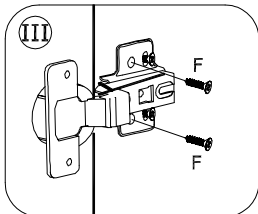
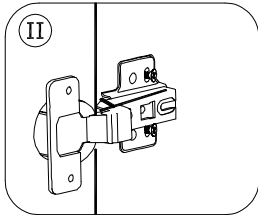
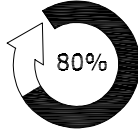
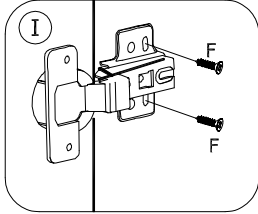
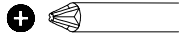
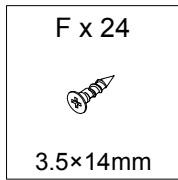

15



16

D x 2	E x 2	R x 6	F x 8
			
Ø18	L=100mm	9x9x14mm	3.5x14mm

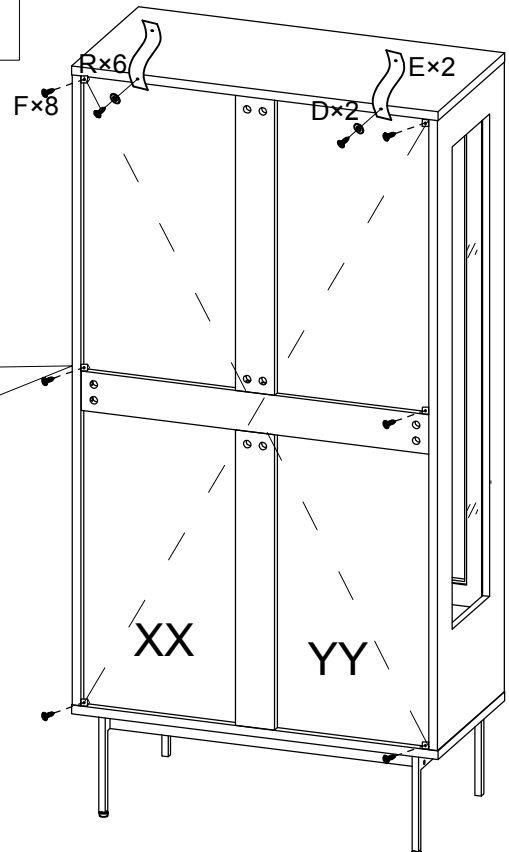
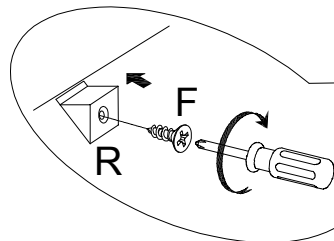
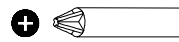

XX=YY

17

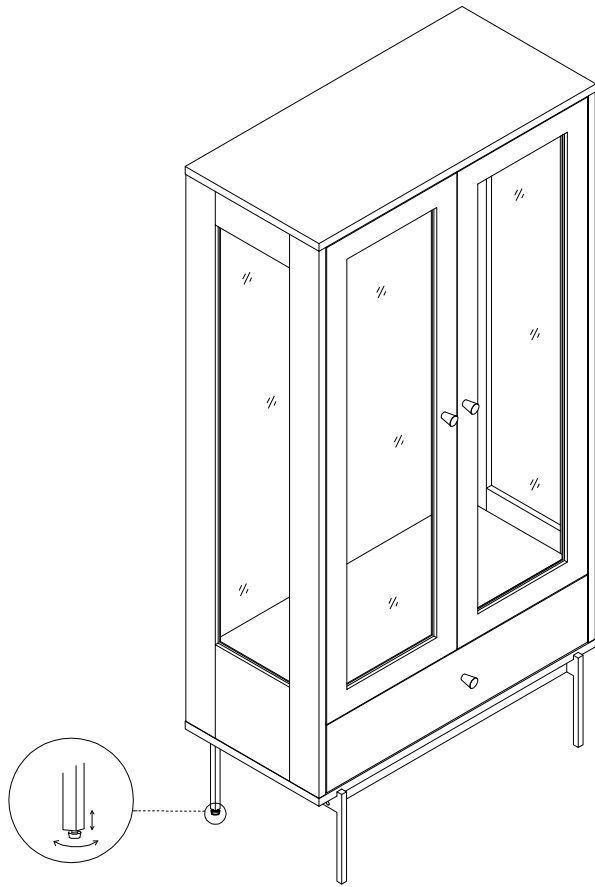

18

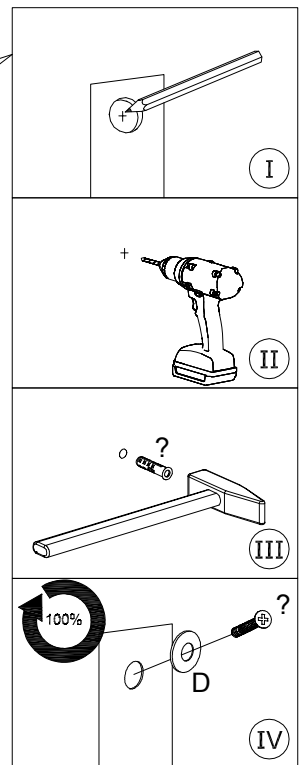
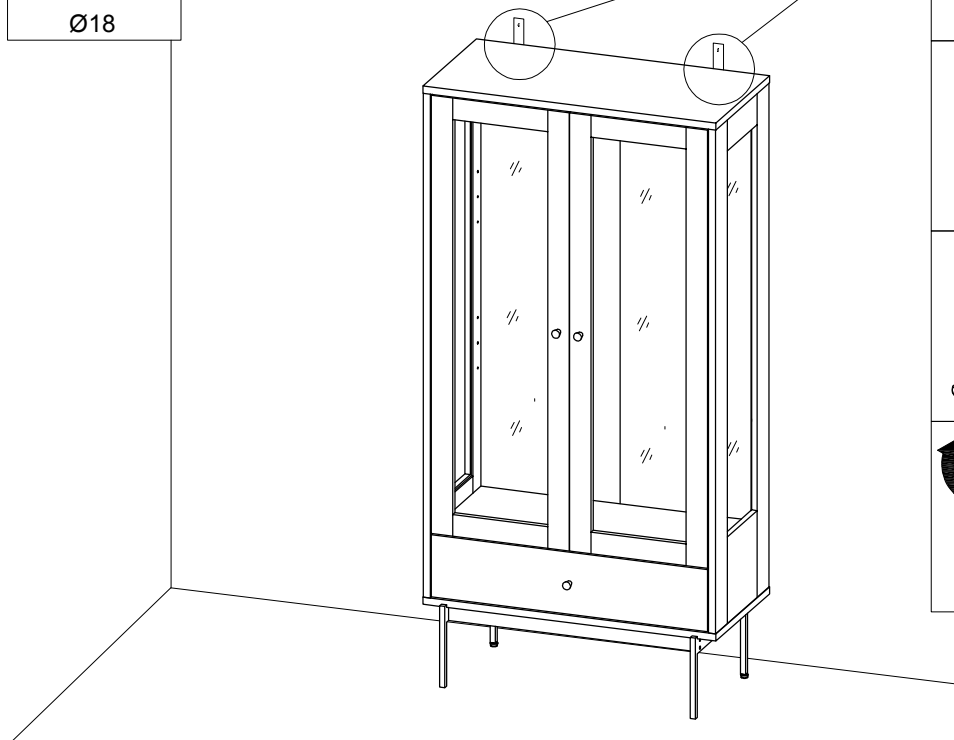
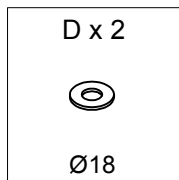

19

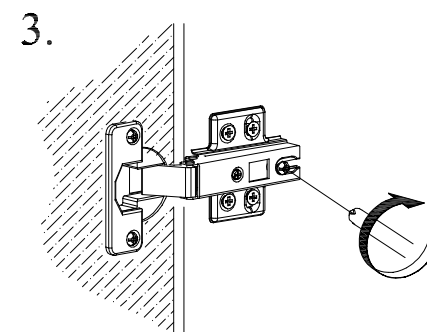
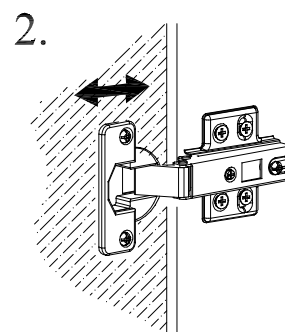
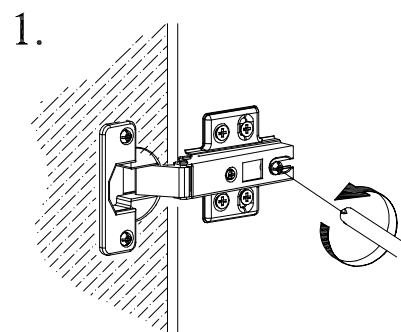
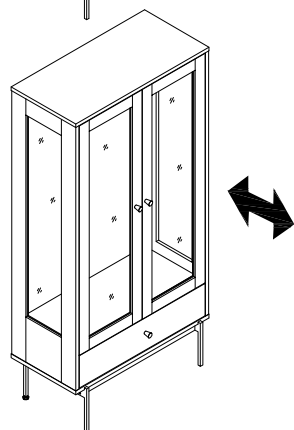
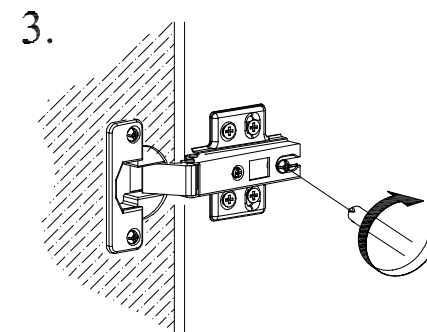
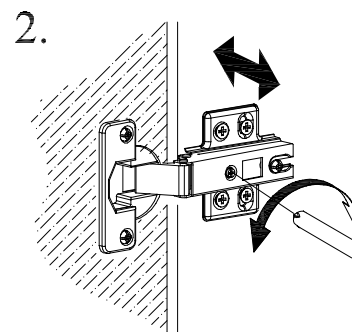
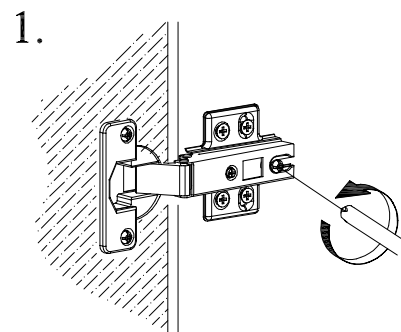
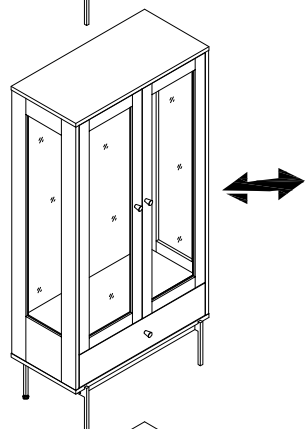
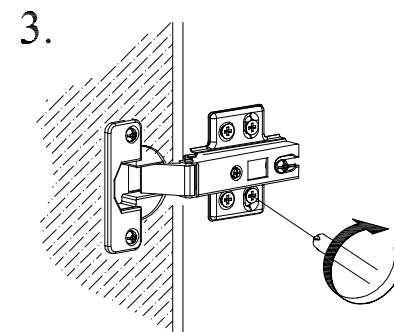
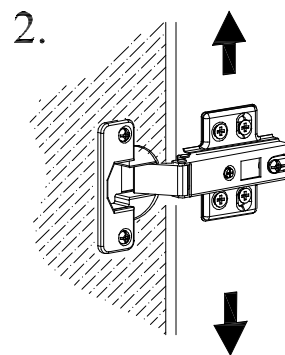
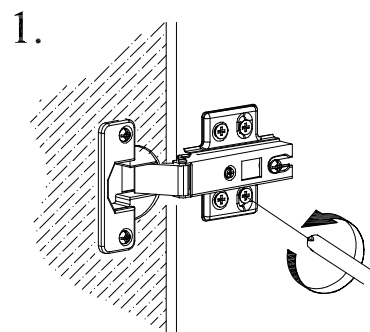
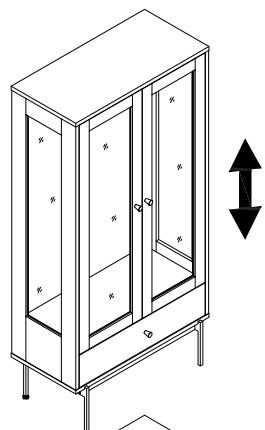
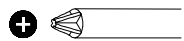

20

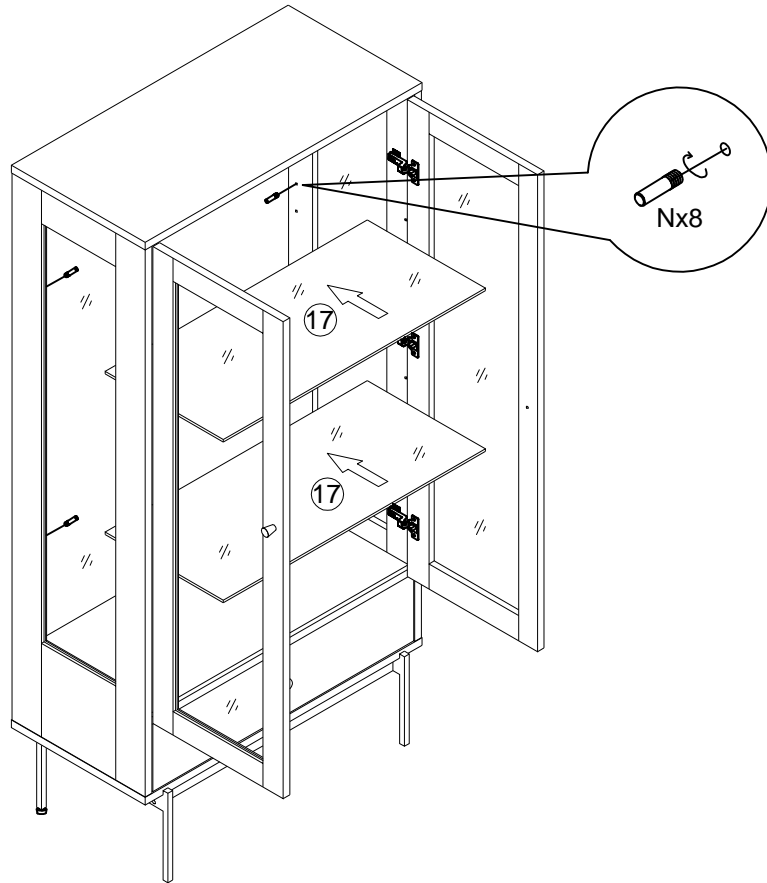
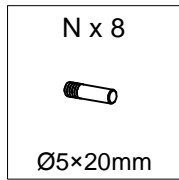

21

