

Instruction

MOD109PL-08BS

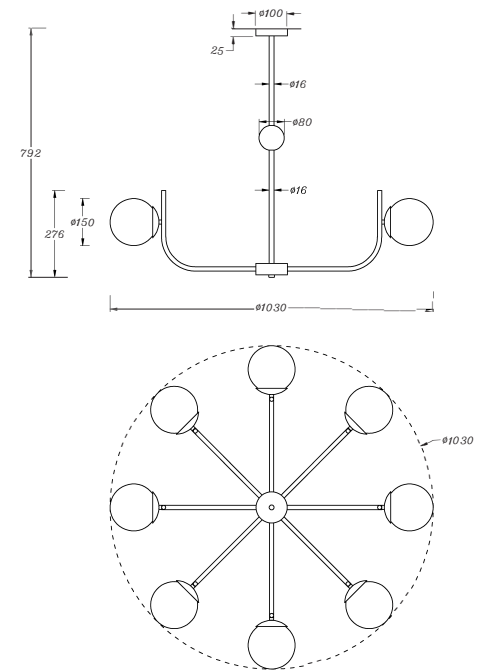
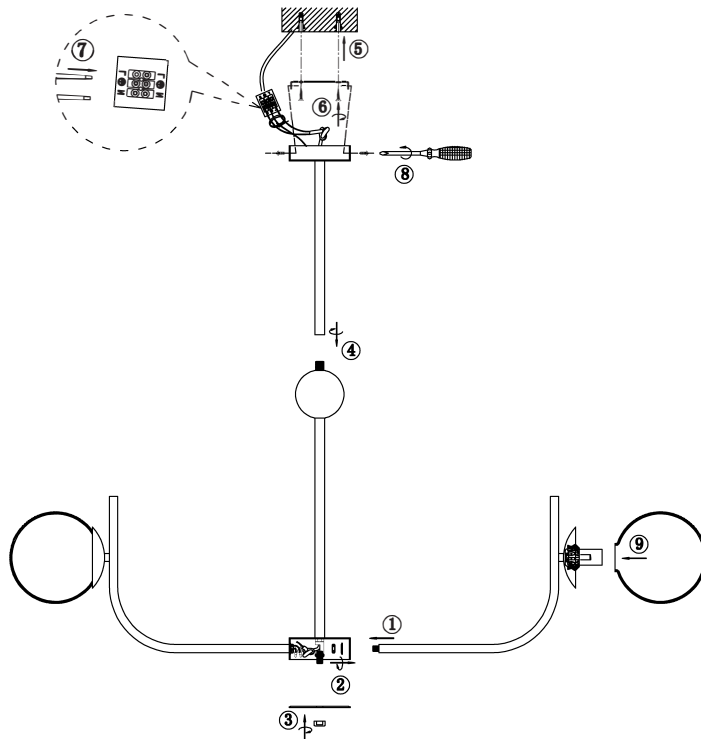

8 x E14 (40W)

Model: MOD109PL-08BS
Collection: Modern



Pendant Lamps