

DESCRIPTION AND PURPOSE USE OF THE DEVICE

The TRX084 series magnetic track system is the basis for building track lighting and is designed for mounting and supplying power to track lights in the DC electrical power grid with 48V of nominal voltage.

The track system is for internal use only where non-aggressive environment free of aerosol particles and temperature range of 0°C to +50°C are guaranteed. The relative humidity should be equal to less than 80 percent. It is possible to mount the track system to walls and ceilings made out of mildly flammable materials. The track system is delivered in particles of different length: either 1, or 2 meters. It is possible to cut and connect those particles in various forms in order to assemble configurations depending on personal demand. Since the entire system is built specifically for 48V of nominal voltage, it is essential to select the necessary power source, which lights every bulb in the circuit.

It is crucial to note that the reserve power supply should not be less than 20% of the overall power consumption for optimal performance. Such ratio provides support for solid continuous functioning and prevents the luminaires from overheating.

SPECIFICATIONS

Segment length	1m	2m
Article	TRX084-111B TRX084-111W	TRX084-112B TRX084-112W
Rated voltage	DC 48V	
Electrical shock protection class	III	
Mounting method	surface-mounted	
Ingress Protection Code	IP20	
Climatic version	Boreal climate (4)	
Operating temperature	0°C - +50°C	
Material	Aluminum	
Color	black /white	

SAFE OPERATION REGULATIONS



All installation and mounting services must be rendered by persons having the appropriate permits and qualifications. Please contact a qualified electrician, where necessary.

All installation and dismantling work should be performed in a powered down state only.

Operation of the track without a power source is forbidden.

Do not connect the track directly to the 230V 50Hz AC mains to prevent the failure of lamps.

When building a track system, do not exceed the total current load of the selected power source considering the power reserve of 20%.

Do not use the product with a damaged housing and damaged insulation of the supply cable.

The product is intended for indoor use only.

Do not use the product in rooms with high humidity and with a high content of dust or aerosol particles in the air.

Use a soft, dry cloth to clean the product with the power switched off. Do not use chemically aggressive cleaning agents.

SURFACE-MOUNTED TRACK

SCHEME OF SURFACE-MOUNTED MAGNETIC TRACK RADIITY

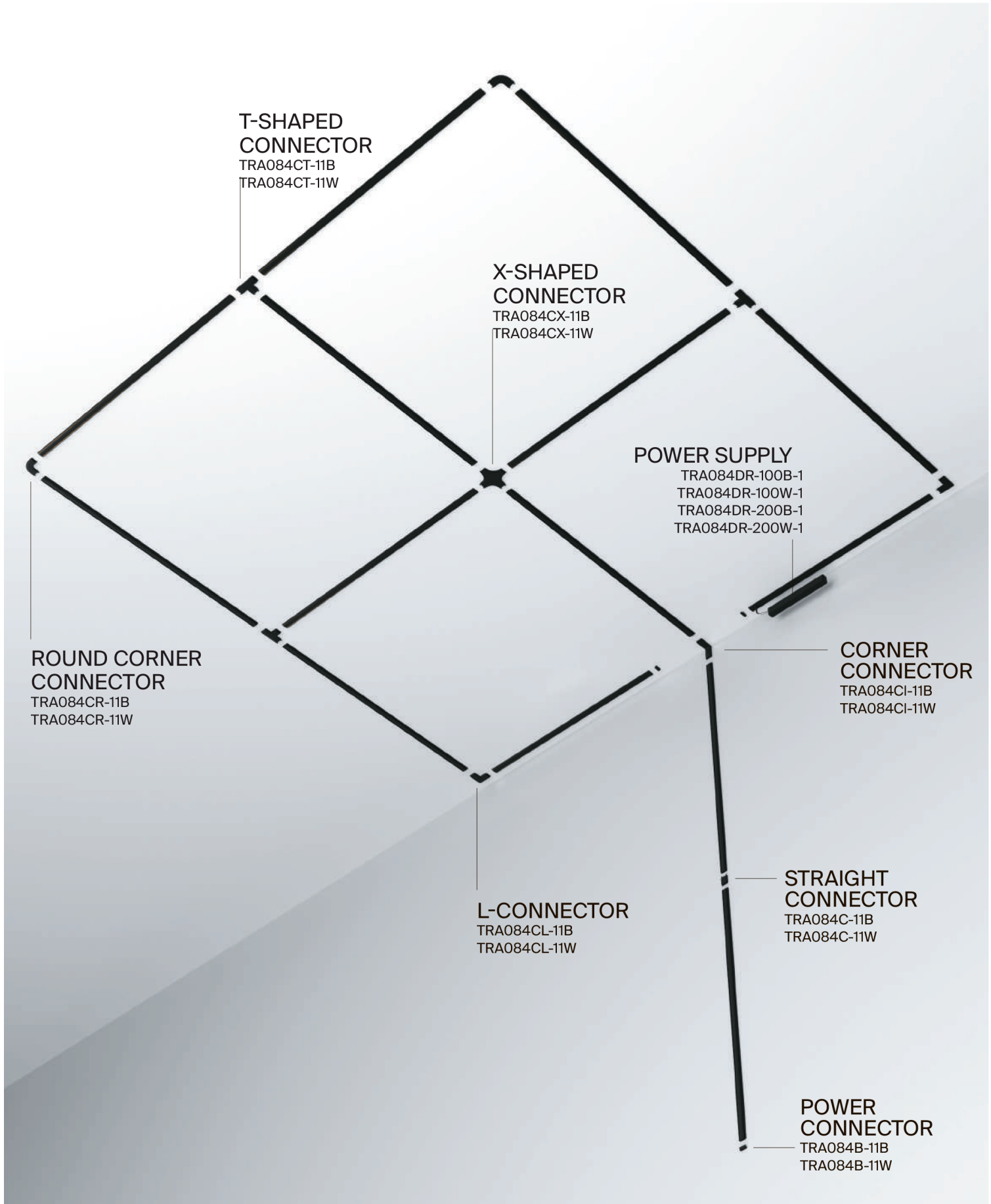

ELEMENTS OF A MAGNETIC TRACK SYSTEM RADITY FOR SURFACE MOUNTING

SYSTEM ELEMENT	COLOR	ARTICLE	SIZE
TRACK	■ BLACK	TRX084-111B	H5.5 X W25 X L1000
	□ WHITE	TRX084-111W	H5.5 X W25 X L1000
	■ BLACK	TRX084-112B	H5.5 X W25 X L2000
	□ WHITE	TRX084-112W	H5.5 X W25 X L2000



SYSTEM ELEMENT	COLOR	ARTICLE
MOUNTING KIT WITH PLUGS, 2 PCS.	■ BLACK	TRX084-111B
	□ WHITE	TRX084-111W
	■ BLACK	TRX084-112B
	□ WHITE	TRX084-112W







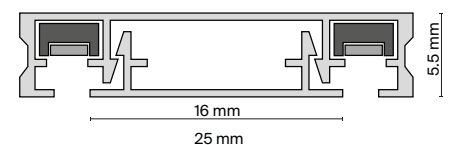
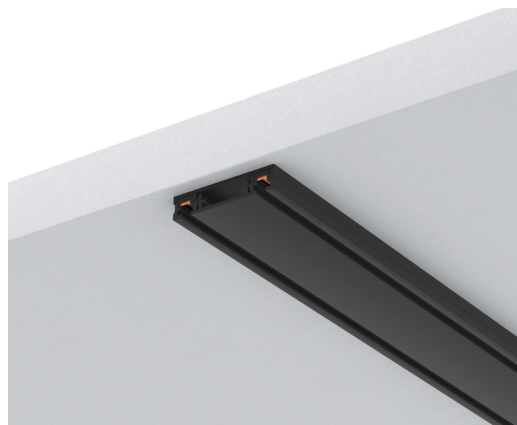
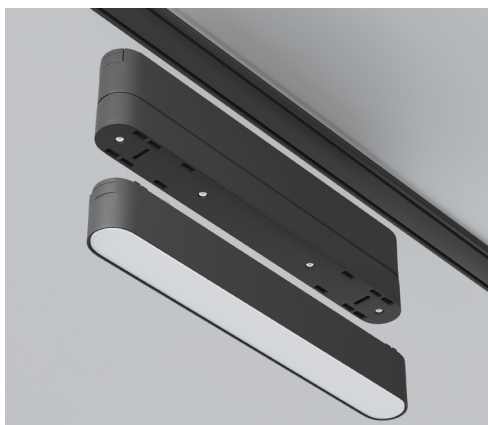





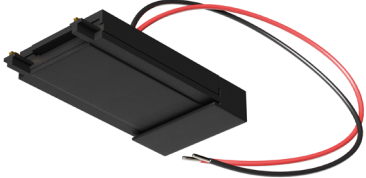

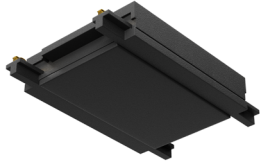

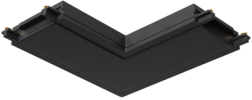



PLUGS ARE NOT INCLUDED, THEY ARE PURCHASED SEPARATELY.

TRX084-111 / TRX084-112 KITS DIFFER FROM EACH OTHER IN THE NUMBER OF SCREWS FOR MOUNTING A BUSBAR OF 1 METER AND 2 METERS



ELEMENTS OF RADITY MAGNETIC TRACK SYSTEM

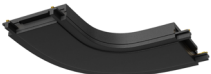

SYSTEM ELEMENT	COLOR	ARTICLE	
POWER CONNECTOR	 BLACK	TRA084B-11B	
	 WHITE	TRA084B-11W	
STRAIGHT CONNECTOR	 BLACK	TRA084C-11B	
	 WHITE	TRA084C-11W	
L-CONNECTOR	 BLACK	TRA084CL-11B	
	 WHITE	TRA084CL-11W	
T-CONNECTOR	 BLACK	TRA084CT-11B	
	 WHITE	TRA084CT-11W	
X-CONNECTOR	 BLACK	TRA084CX-11B	
	 WHITE	TRA084CX-11W	
CORNER CONNECTOR	 BLACK	TRA084CI-11B	
	 WHITE	TRA084CI-11W	
ROUND CORNER	 BLACK	TRA084CR-11B	
	 WHITE	TRA084CR-11W	

POWER CONNECTORS AND DRIVERS



SYSTEM ELEMENT	COLOR	ARTICLE	SIZE	POWER
BUILT-IN POWER SUPPLY	■ BLACK	TRA084DR-100B-1	H28 X W25 X L340	100 W
	□ WHITE	TRA084DR-100W-1	H29 X W25 X L238	100 W
	■ BLACK	TRA084DR-200B-1	H29 X W25 X L259	200 W
	□ WHITE	TRA084DR-200W-1	H29 X W25 X L259	200 W

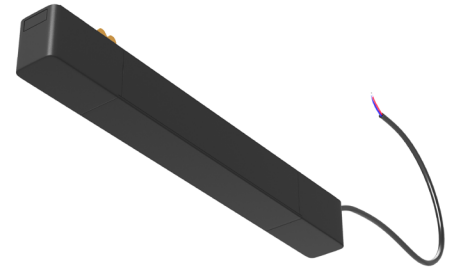

SYSTEM ELEMENT	COLOR	ARTICLE	SIZE	POWER
EXTERNAL POWER SUPPLY	■ BLACK	TRA004DR-100S	H129 X W97 X L30	100 W
	■ BLACK	TRA004DR-150S	H159 X W97 X L30	150 W
	■ BLACK	TRA004DR-200S	H215 X W115 X L30	200 W
	■ BLACK	TRA004DR-320S	H215 X W115 X L30	320 W



INSTALLATION

SURFACE-MOUNTED MAGNETIC TRACK

1. Attach the track on the surface with self-tapping screws.
2. Install the connected power input into the track, through the prepared hole.
3. Install the plugs on the track.

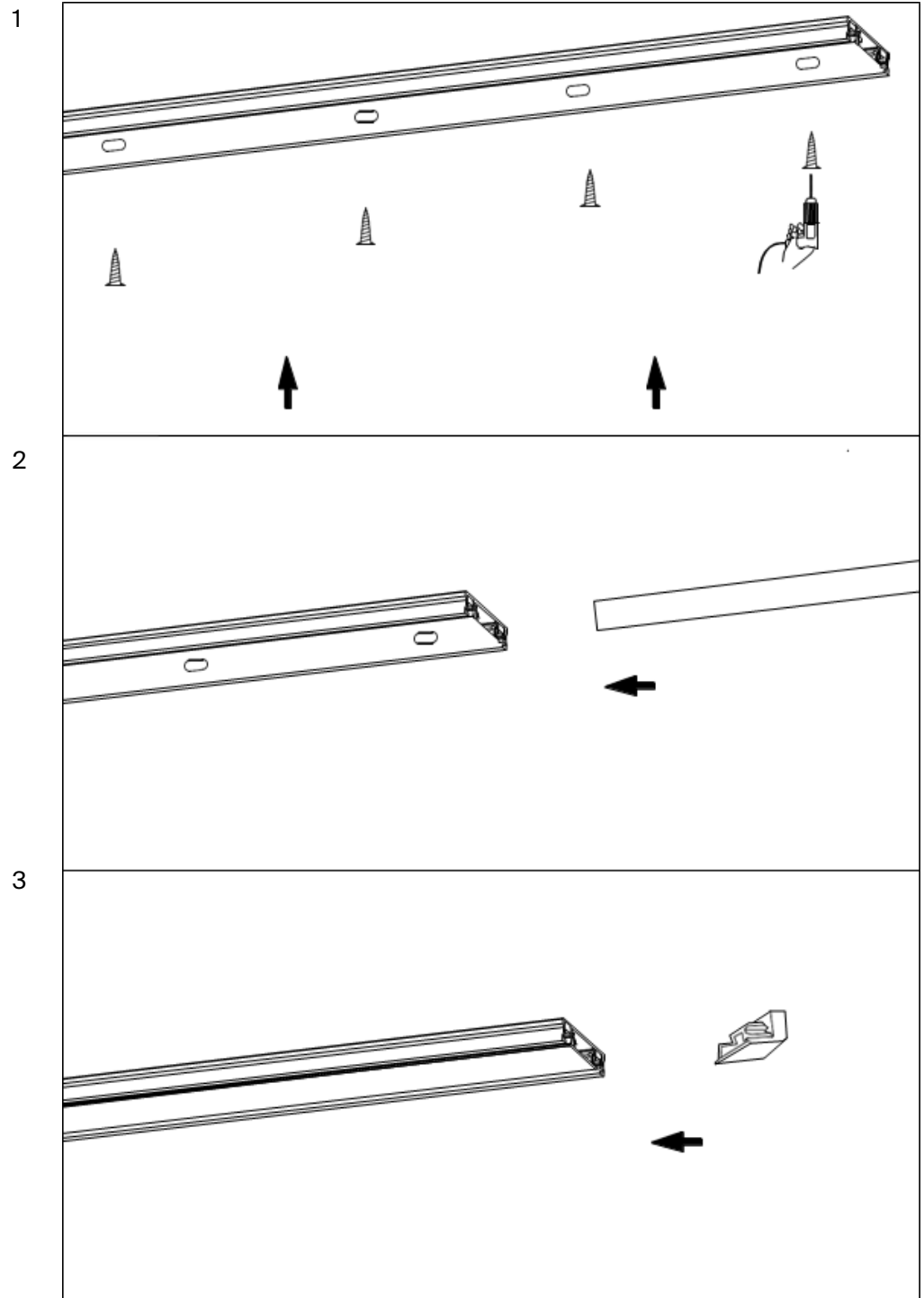

CONNECTING THE POWER TO THE TRACK

1. Prepare a niche, place a driver in it and bring a 230V 50Hz power cable to it.
2. Connect the driver to the network 230V 50Hz according to the designations on it. The power reserve of the driver must be at least 20%. If one power supply does not have enough capacity, you must use a power supply with a higher power rating or divide the circuit into several smaller circuits and use one power supply on each circuit.
3. Connect the power input of the truck to the appropriate terminals of the driver (red wire to the V+ terminal, black wire to the V-terminal).
4. Install the connected power inlet to the track. Connection is carried out when the electrical network is switched off.
5. Install the luminaire into the track until it clicks.

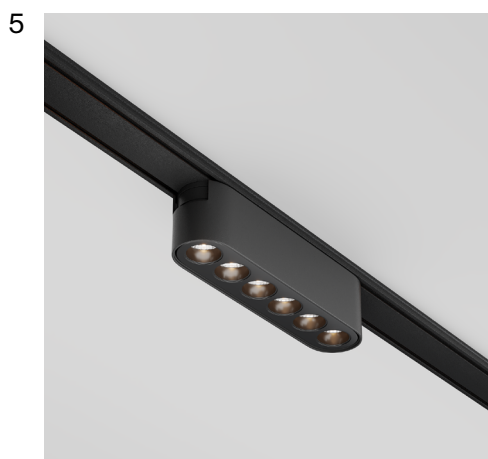
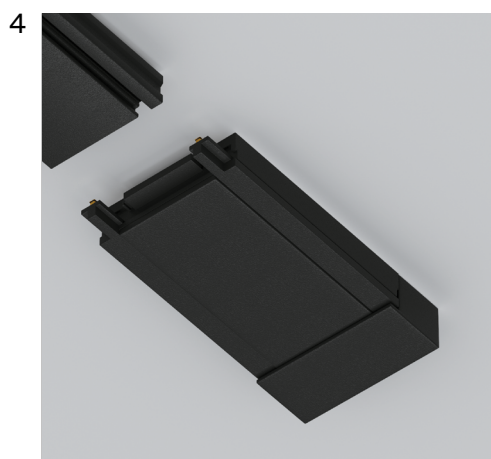
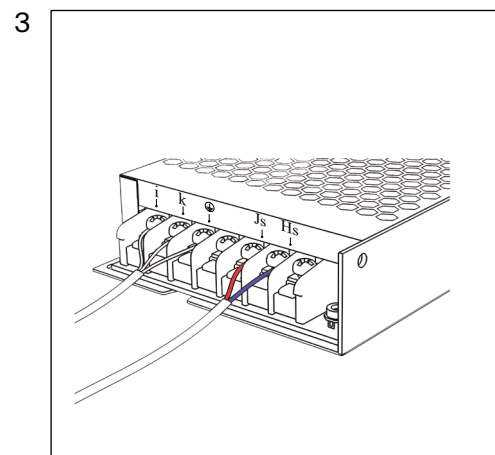
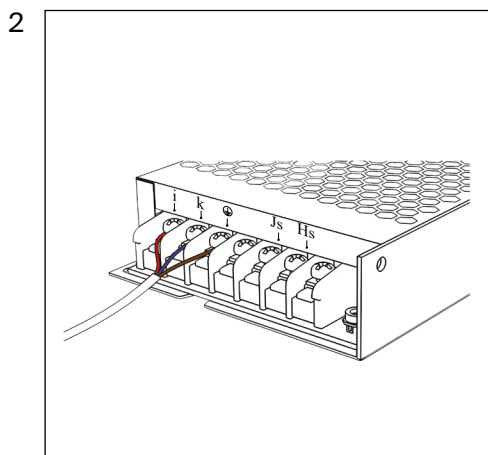
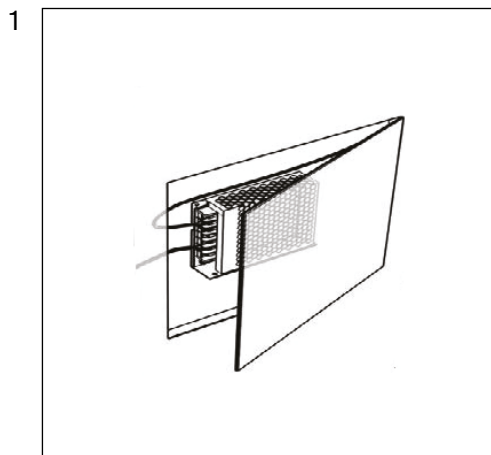

CONNECTING POWER TO THE TRACK USING A COMPACT POWER SUPPLY WITH THE POSSIBILITY OF INSTALLATION IN THE TRACK

When using this power supply, there is no need for power input. These sources are selected in terms of power in the same way as blocks built into niches and require 20% of the total load of the connected luminaires.

1. Connect the track power supply to the mains according to the marking on the input cable (G –ground, L–phase, N –neutral). The connection is carried out when the electrical network is switched off.
2. Place the assembled connection in the track housing.
3. Install the lamp in the track until it clicks.



TIPS AND PRECAUTIONS

1. When planning the placement of system elements, be sure to include an inspection hatch in the project to service the driver.
2. Do not deform the track during transport and installation.
3. When cutting track, use professional equipment, or use the services of an organization providing such services.
4. Through 1 power input, you can connect lamps with a maximum total power of 400W and a track no longer than 20 meters. If the specified power or length is exceeded, it is necessary to connect subsequent sections through a new power input.
5. The power input can be installed in any section of the track, guided by rule 1, the input feeds no more than 20 meters of the track.
6. Be extremely precise when laying out and installing the wall brackets. If you move them out of the path of the truck, you may have difficulty installing it.

Fault description	Cause	Troubleshooting
The lamp does not work	Loose connection of current-carrying parts	Install the lamp on the track until the adapter is in full contact with the current-carrying cores
		Check the input cable connection terminals, the connection of the power input terminals to the track, and other connections.
		Contact the seller for a replacement under warranty
	Lamp failure	
The lighting fixture flashes or glows dimly in switched-off state	To control the lighting circuit, a switch with key backlighting is installed, or a motion (light) detector is used	Replace the switch with a model without key backlighting, or which has an additional resistor in its design. Use motion (light) detector only with relay output
Unstable glow, flickering, extraneous sound	Brightness control (dimmer switch) is installed in the power supply circuit	Remove the dimmer from the circuit, replace it with a switch
	Faulty power supply	Contact the seller for a replacement under warranty

STORAGE

The goods are stored in packaging indoors in the absence of an aggressive environment. Storage temperature in the range from -20°C to +70°C and relative air humidity not more than 95%. Direct exposure to moisture is not allowed.

TRANSPORTATION

The packaged product is suitable for transportation by sea, rail, road and air.

DISPOSAL

The product in its design does not contain toxic and chemically hazardous compounds, therefore it is subject to the rules for the disposal of municipal solid waste.

WARRANTY

The warranty for the product is 24 months from the date of sale, the date is established on the basis of documents establishing the fact of sale.

Warranty service is provided if the malfunction occurred due to the defect in workmanship, and also subject to all the rules of operation, transportation and storage given in this manual.

The warranty is not valid in the following cases: if the product has been used for purposes that do not correspond to its intended use; the defect arose after the transfer of the goods to the consumer and is caused by incorrect or careless handling, non-compliance with the requirements given in this manual. And also in cases of force majeure, including: fire, flood, high-voltage discharges and other natural disasters, accidents and deliberate actions of third parties that caused the product to malfunction.

MANUFACTURER

Maytoni GmbH, Feldstiege 98, Münster, Germany, 48161

IMPORTER

Maytoni GmbH, Feldstiege 98, Münster, Germany, 48161

www.maytoni.de

Developed in Germany.

Made in China.

Shelf life is not limited.

